

# POPULAR COMMUNICATIONS

## Scanning Mall Security Forces

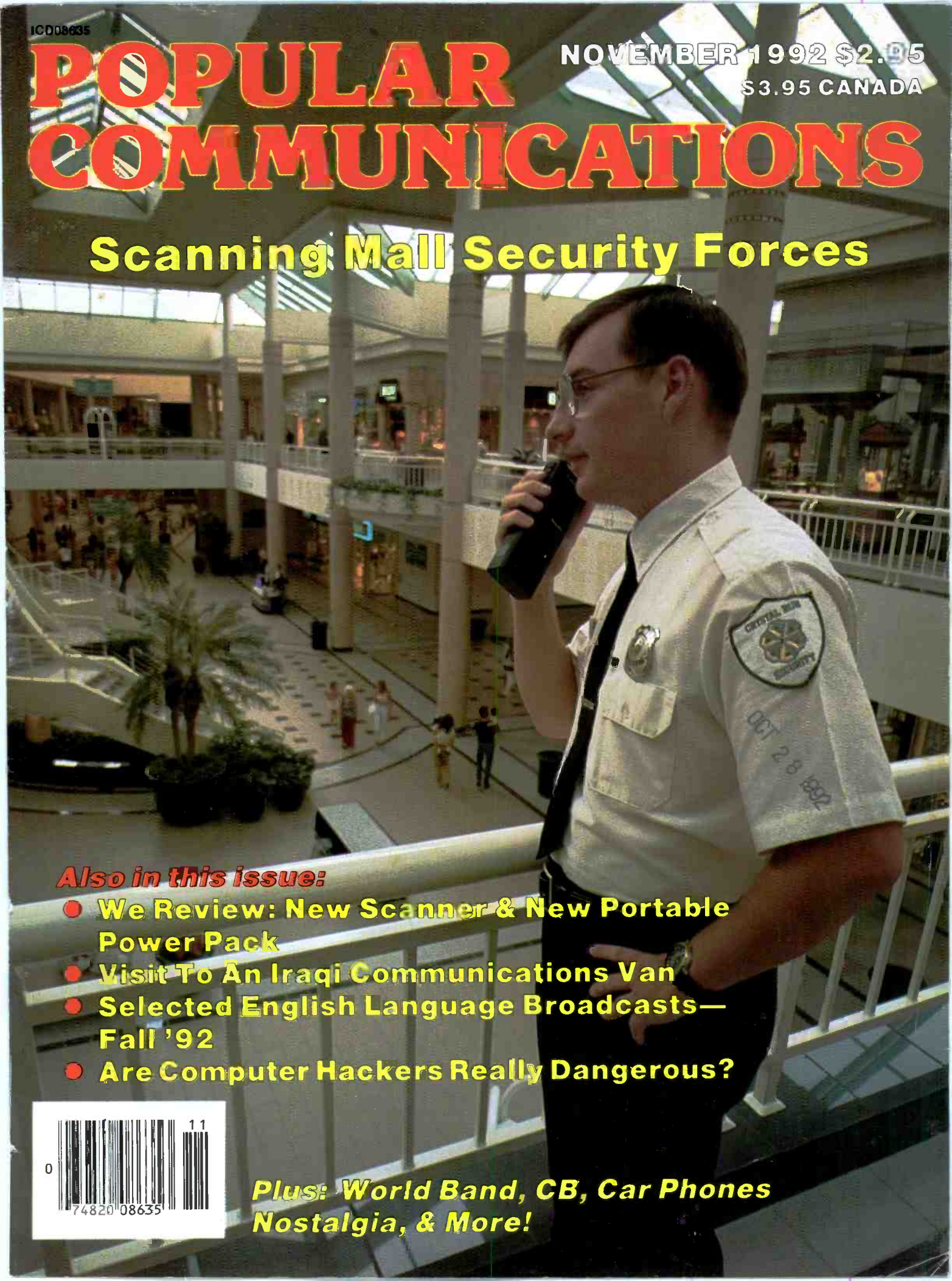

### Also in this issue:

- We Review: New Scanner & New Portable Power Pack
- Visit To An Iraqi Communications Van
- Selected English Language Broadcasts—Fall '92
- Are Computer Hackers Really Dangerous?



Plus: World Band, CB, Car Phones Nostalgia, & More!

# TAKE THE WORLD ON THE ROAD

## WORLDWIDE RECEIVERS FROM ICOM

### IC-R1 HANDHELD RECEIVER

The smallest wideband handheld available today, the IC-R1 continuously covers 100kHz-1300MHz with AM, FM and wide-band FM modes. This tiny receiver goes anywhere you go, measuring just 1.9"W x 4.0"H x 1.4"D.

Easy operation is a snap with the IC-R1's Dual Frequency Selection (direct keyboard and rotary tuning), 100 memories and a 24-hour clock complete the world's smallest full-featured handheld receiver.



### IC-R100 MOBILE RECEIVER

Whether you're at home or in your car, the IC-R100 gives you continuous coverage from 100kHz-1856MHz in AM, FM and wide-band FM modes. Monitor VHF air and marine bands, emergency services, government and amateur stations. 21 fully programmable memory channels, multiple scanning systems and a built-in backup lithium battery.



### IC-R72 BASE RECEIVER

The IC-R72 continuously receives 100kHz-30MHz in SSB, AM and CW modes with exceptionally high sensitivity. An optional U-E provides 5M reception. The IC-R72 incorporates a noise blanker, five scanning systems, internal backup battery and built-in clock with Icom's CBS System. The IC-R72 boasts a 130dB wide dynamic range while an easy-to-access keyboard provides convenient programming versatility... superb for shortwave listeners!



See our complete line of quality receivers at your local authorized Icom dealer

CORPORATE HEADQUARTERS  
ICOM America, Inc., 2380-116th Ave. N.E.  
Bellevue, WA 98004  
CUSTOMER SERVICE HOTLINE  
(206) 454-7679  
CUSTOMER SERVICE CENTERS:  
181C Skypark South, Suite 52-B  
Irvine, CA 92714  
1777 Phoenix Parkway, Suite 201  
Marietta, GA 30069  
8071 #5 Road, Unit 9  
Richmond, B.C. V6X 2T4 Canada  
\*38C-116th Ave. N.E., Bellevue, WA 98004  
All stated specifications are subject to change without notice or obligation. All ICOM radios significantly exceed FCC regulations limiting spurious emissions. R1991

For full details call the Icom Brochure Hotline at 1-300-999-9877.





# RECESSION BREAKING SALE

THESE SALES PRICES ARE ONLY GUARANTEED TILL September 30, 1992 HURRY, CALL NOW!

**ICOM SIMPLY THE BEST!**  
NEW R7100 25-2000MHz  
900 Memories AM/FM/FMW/CW/SSB, Clock, Recorder Control, many specs same as R7000. Much improved sensitivity. Only 9.5x3.7x9.4" 13 lbs.



ICOM List \$1497

EEB \$1269<sup>+SH</sup>

ICR7000  
ICR71A  
ICR72A  
ICR9000  
ICR100

List \$1431 EEB \$1199<sup>+sh</sup>  
List \$1204 EEB \$939.95<sup>+sh</sup>  
List \$1103 EEB \$4975<sup>+sh</sup>  
List \$5851 EEB \$<sup>+sh</sup>  
List \$721 EEB \$<sup>+sh</sup>

**NEW** SONY M770V



•Turn your scanner into a logger. No time gaps  
•Record all the action listen later  
•Time/date/digital record/play on LCD  
•Ext. audio In/Out, Built-in mic.  
•Audio auto start/stop  
•2.4 x 5 x 1.14" 7.4 oz.

List \$119.95

EEB \$99.95<sup>+sh</sup>

Sony's Newest

ICFSW77

World's most sophisticated portable AM/FM/SWL receiver, 160 memory, Station name tuning synchro detection, CW-SSB! 10.8 x 6.8 x 1.8in 52oz. LIST \$629.95

\$499.95<sup>+SH</sup>



SONY ICFSW55

Latest in HI TECH portables, 125 memories, Station name tuning, Full SW,AM, FM coverage, SSB, Tune 100Hz steps. \$449.95



EEB \$369.95<sup>+SH</sup>

ICFSW7600 \$219.95

ICFSW800 \$129.95

**SPECIAL LIMITED STOCK**

ICFSW1S \$CALL

PRO80 \$CALL

**NEW LOW-NOISE Pre-Amp**  
NOW Up To 25% OFF

•Improve your scanner performance  
•Low noise GaAs, FET  
•Hi-quality surface mt.  
•M100/M75 24-2150MHz  
Gain-6 +20dB, Band select switch full, 108-185 & 225-1500  
•M100 Auto Switch 5W HT Pow  
•M50 Fixed Gain 25-1300MHz  
•M50 Fixed Gain 25-1300MHz  
•M100/M75 9V batt or ext. 12V  
\$99.95  
\$119.95  
\$149.95

**SPECIAL PURCHASE**  
GRUNDIG SATELLITE 500



FREE Instructional Video and Dust Cover  
SW 1.6-30MHz LW, AM, FM  
•42 Memory •Synchro AM Detection •AM, FM, LSB, USB •Best Audio of any Portable  
•Alpha/Numeral Station ID Memory •120/220V AC/13VDC/4 "D" Cell (opt. Nicad)  
National ad up to \$699.95  
NOW on Limited SALE \$399.95<sup>+sh</sup>

**AOR SCANNERS**

AR1000 5-1300MHz

1000 memories, search 40/sec. AM/FM/FMW  
Key Pad or manual tuning 4 AA Nicad, charger, DC Lig. Plug, case, belt clip, car phone included!  
6.7x2.6x1.4 15oz  
Advertised at \$499

NOW EEB \$399.95<sup>+SH</sup>



AR3000A

Upgraded AR3000  
New CPU 1-2036MHz  
400 mem, scan 50ch/sec  
13.8VDC .5A AC adpt included!

LIST \$1095

EEB \$995<sup>+SH</sup>

**THE ULTIMATE COMPACT SCANNER**



**REALISTIC SCANNERS DISCOUNT PRICES**

PRO2006 HYPERSCAN

"THE BEST SCANNER UNDER \$800"

\*25-520/760-1300MHz\*  
\*SIMPLE MOD RESTORES CELLULAR INCL 400 MEMORIES (10 BANKS)  
\*SCAN 26CH/SEC.  
\*120VAC & 13.8VDC  
\*NEW COR Recorder Remote \$75



LIST \$399.95 EEB \$369.95<sup>+SH</sup>

PRO37 NEW HYPERSCAN

\*200 MEMORY  
\*SCAN 26CH/SEC.  
\*COVERS ALL 800 MHz EXCEPT CELLULAR

LIST \$299.95 EEB SPECIAL \$CALL<sup>+SH</sup>

**ICOM R1**

ICOM R1 World's smallest scanner!



.1 to 1300MHz, no gaps  
AM, FM, FMW,  
100 memories.

Only 1.9x4.0x1.4 9.9 ozs.  
Listen to shortwave, local AM/FM, Police, Airband, Amateurs, TV sound. ALL 800MHz!

The World of Radio in Your Hand!  
ICOM LIST WAS \$625  
NOW EEB Priced at only \$449.95

**FAIRMATE SCANNER SALE**

HP2000 5-1300MHz \$379.95  
BEARCAT  
BC100XLT VHF/UHF \$199.95  
BC200XLT VHF/UHF/800 \$239.95  
BC700XLT VHF/UHF/800 \$279.95  
BC800XLT VHF/UHF/800 \$249.95



ELECTRONIC EQUIPMENT BANK  
323 Mill Street NE  
Vienna, VA 22180

ORDERS: 800-368-3270  
Local Tech: 703-938-3350  
FAX: 703-938-6911

\* Sorry, no COD's  
\* Free Catalog in USA  
\* Battery's not included  
\* Prices subject to change  
\* Prices do not include freight  
\* Returns subject to 20% restock fee

# POPULAR COMMUNICATIONS

NOVEMBER 1992

VOLUME 11, NUMBER 3

## FEATURES

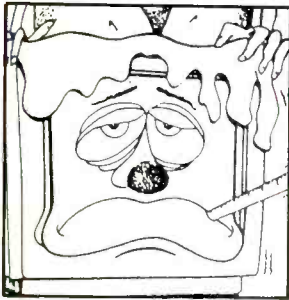

4

**Scanning Mall Security** 9  
Monitor The Private Police Security Forces Patrolling Large Malls  
*By Tom Kneitel, K2AES*

**Radio: The Good Old Days** 11  
Return To Those Thrilling Days Of Yesteryear  
*By Alice Brannigan*

**Books You'll Like** 16  
Privacy Pirates, Radio On The Road, And A Reference Guide To The AR1000  
*By R.L. Slattery*

**POP'COMM Reviews: We Look At Two New Products For Communications Hobbyists** 20  
*By POP'COMM Staff*

**Selected English Language Broadcasts Fall 1992** 22  
*By Gerry Dexter*

**Visit To An Iraqi Comms Van** 28  
Exclusive Photos! Let's Say, It Was Less Than Expected  
*By Ahmed M. Alsayyed, A7ICD*



20

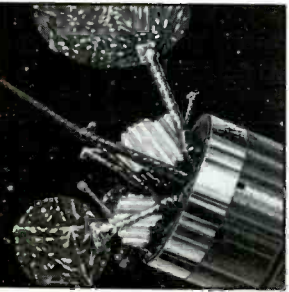

48

## COLUMNS

Broadcast DXing	30
Pirates Den	35
Scanning VHF/UHF	36
You Should Know	38
Antennas 'n' Things	42
CB Scene	44
How I Got Started	47
Satellite View	48
Telephones Enroute	50
Washington Pulse	52
RTTY	58
Listening Post	63
Communications Confidential	66

## DEPARTMENTS

Beaming In	4
Mailbag	6
New Products	19
Worldband Tuning Tips	40
Communications Shop	76

**This month's cover:** USA: Mall Security at the Crystal Run Galleria Mall, Middletown, NY. Photo by Larry Mulvehill.

## EDITORIAL STAFF

**Tom Kneitel, K2AES/KNY2AB**, Editor  
**Jeanine M. O'Connor**, Associate Editor

## CONTRIBUTING EDITORS

**Gerry L. Dexter**, Shortwave Broadcast  
**Robert Margolis**, RTTY Monitoring  
**Gordon West, WB6NOA**, Emergency  
**Don Schimmel**, Utility Communications  
**Edward Teach**, Alternative Radio  
**Harold A. Ort, Jr.**, Military Consultant  
**Janice Lee**, Radar Detectors  
**Chuck Gysi, N2DUP**, Scanners  
**Roger Sterckx**, AM/FM Broadcasts  
**Harry Helms, AA6FW**, Thoughts and Ideas  
**Donald Dickerson, N9CUE**, Satellites  
**Kirk Kleinschmidt, NT0Z**, Amateur Radio  
**Joe Carr, K4IPV**, Antennas

## BUSINESS STAFF

**Richard A. Ross, K2MGA**, Publisher  
**Donald R. Allen, N9ALK**, Advertising Mgr.  
**Emily Kreutz**, Sales Assistant  
**Dorothy Kehrwieler**, General Manager  
**Frank V. Fuzia**, Controller  
**Catherine Ross**, Circulation Director  
**Melissa Kehrwieler**, Data Processing Manager  
**Carol Licata**, Data Processing  
**Denise Pyne**, Customer Service

## PRODUCTION STAFF

**Elizabeth Ryan**, Art Director  
**Barbara Terzo**, Assistant Art Director  
**Susan Reale**, Artist  
**Edmond Pesonen**, Electronic Composition Mgr.  
**Dorothy Kehrwieler**, Production Manager  
**Emily Kreutz**, Production  
**Pat Le Blanc**, Phototypographer  
**Hal Keith**, Technical Illustrator  
**Larry Mulvehill, WB2ZPI**, Photographer

A publication of



CQ Communications, Inc.  
76 North Broadway  
Hicksville, NY 11801-2953 USA.

Offices: 76 North Broadway, Hicksville, NY 11801. Telephone 516 681-2922. FAX (516) 681-2926. Popular Communications (ISSN 0733-3315) is published monthly by CQ Communications, Inc. Second class postage paid at Hicksville, NY and additional offices. Subscription prices: Domestic—one year \$19.95, two years \$38.00, three years \$57.00. Canada/Mexico—one year \$22.00, two years \$42.00, three years \$63.00. Foreign—one year \$24.00, two years \$46.00, three years \$69.00. Foreign Air Mail—one year \$77.00, two years \$152.00, three years \$228.00.

U.S. Government Agencies: Subscriptions to Popular Communications are available to agencies of the United States government, including military services, only on a cash with order basis. Requests for quotations, bids, contracts, etc. will be refused and will not be returned or processed.

Entire contents copyright ©1992 by CQ Communications, Inc. Popular Communications assumes no responsibility for unsolicited manuscripts, photographs, or drawings. Allow six weeks for change of address or delivery of first issue. Printed in the United States of America.

Postmaster: Please send change of address to Popular Communications, 76 North Broadway, Hicksville, NY 11801.

44

# MONITOR MORE WITH ADVANCED EQUIPMENT FROM UNIVERSAL!

## COMMUNICATIONS RECEIVERS

### Japan Radio NRD-535D



Triple conversion power with ECSS, Bandwidth Control and 3 filters included. Now with the improved BWC. .... **\$1699.00 (+\$16)**

### Japan Radio NRD-525

Rated five stars and *Editor's Choice* by Larry Magne in *Passport '91*. .... **\$899.95 (+\$15)**

### Drake R-8

A state-of-the-art receiver for the 90's. Five bandwidths, Syncro., etc. .... **\$959.95 (+\$11)**

### Kenwood R-5000

A powerful receiver for the serious DXer. An exceptional value. .... **\$879.95 (+\$12)**

### Lowe HF-150 NEW! Made in England.

Finally ... a true portable communications receiver. Write for brochure. .... **\$599.95 (+\$7)**

## PORTABLE RECEIVERS

### Panasonic RFB-45



Keypad, 18 memories, scan and search functions, S.S.B., fine tuning knob, clock-timer, S-METER, etc. .... **\$169.95 (+\$5)**

### Sony ICF-2010

Super high performance and features. VHF air too. .... **\$359.95 (+\$6)**

### Sangean ATS-818CS

Finally, a quality digital receiver with cassette, 45 mems., SSB. .... **\$249.95 (+\$7)**

### Grundig Satellit 500

Hi-tech with beautiful fidelity and style. Synchronous tuning. .... **\$399.95 (+\$6)**

*Note: Radios listed above are all LW-MW-SW-FM digital. Contact us for other models.*

## SPECIAL RECEIVERS

### Icom R-9000



Solid all-mode coverage from .1 to 1999.8 MHz. Multi-function CRT with spectrum analyzer. The ultimate receiver! ..... **\$4795.00 (+\$30)**

## SHORTWAVE ANTENNAS

### Alpha Delta DX-SWL Sloper

MW +120-13 meter bands (60'). .... **\$67.95 (+\$5)**

### Alpha Delta DX-SWL Sloper-Short

90-13 meter bands (40'). .... **\$57.95 (+\$5)**

### Eavesdropper Specify twin lead or coax type

9 SW bands (60-10 meters). .... **\$74.95 (+\$5)**

### McKay Dymek DA100D Active Antenna

The Cadillac of active antennas! **\$179.95 (+\$5)**

### B&W ASW-90 Full Coverage Dipole

Covers 3.5-30 MHz solid! .... **\$89.95 (+\$6)**

*Note: Many other shortwave, amateur and scanner antennas available in our catalog.*

## MULTI-MODE CONVERTERS

### Universal M-8000



If you are only *listening* to your shortwave radio you are missing half the fun. With the addition of a Universal decoder and monitor you can *see* the world. The shortwave spectrum is filled with interesting text messages and photos that you can intercept and display. If this sounds interesting to you, request our two free pamphlets: *Listening to Radioteletype and Receiving FAX on Your Shortwave Radio*. Shown above is the new Universal M-8000 which decodes modes not previously available. Contact us today for information on the full line of Universal decoders.

#### You can monitor:

- ◆ Coastal Station Traffic
- ◆ Ship Telexes
- ◆ Press Reports
- ◆ Press Photos
- ◆ Satellite Photos
- ◆ Weather Maps
- ◆ Unclass. Military Traffic
- ◆ Diplomatic Traffic
- ◆ Ham Messages
- ◆ Weather Reports
- ◆ Research Traffic
- ◆ Packet Messages
- ◆ Radio Bulletins

## COMMUNICATIONS BOOKS

### Passport To Worldband Radio

By *L. Magne*. Graphic presentation of all SWBC stations. Equipment reviews too. .... **\$16.95**

### Shortwave Receivers Past & Present

By *F. Ostiarman*. Your guide to 200 receivers with new-used value, specs, features. .... **\$8.95**

### Aeronautical Communications Handbook

By *R. Evans*. A mammoth book on all aspects of shortwave aero listening. 266 pages. .... **\$19.95**

### Complete SWL's Handbook Third Edition

By *Bennett, Helms, Hardy*. Nearly 300 pages on all aspects of SWL'ing. .... **\$16.95**

### Guide To Utility Stations

By *J. Klingenfuss*. The definitive guide to utility stations- CW, SSB, FAX and RTTY. .... **\$34.95**

### Easy-Up Antennas for Listeners & Hams

By *E. Noll*. Low cost, easy to erect antennas for LW, MW, FM, SW, SCAN and HAM. .... **\$16.95**

### World Radio TV Handbook

All SWBC stations by country with schedules, addresses, power, etc. Reviews too. .... **\$19.95**

◆ Please add \$1 per title for shipping.

### Universal M-1000

Turn your IBM computer (or compatible) into a powerful intercept device! The Universal M-1000 Decoder Card requires just one full-size slot in your PC. Your computer can open up a new world of listening (... or *seeing*) opportunities! Standard reception modes are included such as Morse Code, Baudot RTTY and Sitor A/B. Advanced diplo-military modes such as ARQ-M2, ARQ-E and ARQ-E3 are supported plus ASCII and Packet. Advanced RTTY enthusiasts will appreciate the *Databit* and *Literal* modes, helpful in protocol identification and decryption. The video quality of your FAX intercepts will amaze you. Advanced FAX imaging includes false-color and zoom features. FAX images as well as text traffic can be saved on to disk. Operation is easy through on-screen menus, status indicators and help windows. A new *datascope* feature operates in both RTTY and FAX modes. This device merely requires audio from your receiver. The M-1000 comes with an informative manual and software on both 3 1/2" and 5 1/4" disks. Upgradable for future optional codes. Six month limited warranty. Made in the U.S.A. **Write for information. \$399.95 (+\$5)**

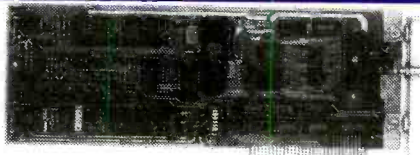

- Universal ships worldwide.
- Prices and specifications are subject to change.

- Universal in business since 1942.
- Visa, Master & Discover Card.
- Used equipment list available.

## COMMUNICATIONS CATALOG

Universal now offers a new combined communications catalog covering shortwave, amateur and scanner equipment. There is also an unbeatable selection of antennas, books, parts and accessories. This **HUGE 100 PAGE** (8 1/2" by 11") publication covers everything for the radio enthusiast. With prices, photos and full descriptions.

**Available FREE by fourth class mail or \$1.00 by first class mail.**

**Universal Radio, Inc.**  
**6830 Americana Pkwy.**  
**Reynoldsburg, Ohio**  
**43068 U.S.A.**

**800 431-3939 Orders**  
**614 866-4267 Information**  
**614 866-2339 Facsimile**



**NOW—NO CODE!**

**The Ham Radio Handbook** by Don Stoner gets rave reviews as the best training aid to help you earn the no-code ham license. Over 200 pages, packed with information—all the test questions, correct answers and the theory behind the questions. Only \$9.95 (\$2.00 S&H).

**YOU CAN PASS THE CODELESS HAM RADIO TEST AND WE GUARANTEE IT!**

It's easy and fun with the **NARA Education Package**. You get Don Stoner's *Ham Radio Handbook*, IBM or Macintosh compatible software to test your knowledge after you have studied the book; an extensive list of Volunteer Examiners you can contact, the *FCC Rules and Regulations* for ham radio, a copy of *Amateur Radio King of Hobbies*, plus a bonus copy of our journal, *The Amateur Radio Communicator*, by mail. The **NARA Education Package** is only \$29.95 for the IBM or \$49.95 for the Mac version (\$3.00 S&H).

**Join NARA today** and enjoy the exciting world of ham radio — and beginners don't need to know the code! A one-year **NARA** membership & subscription to *The Amateur Radio Communicator* is only \$10.00.



**CALL US TODAY!!**

P.O. Box 598, Redmond, WA 98073  
Orders Only 1-800-GOT-2-HAM  
Inquiries (206) 869-8052

CIRCLE 144 ON READER SERVICE CARD

Save on ALL  
**Radio Shack**  
Scanners & Radios

WITH  
MANUFACTURERS  
WARRANTY  
IN  
AMERICA

NEW  
PRO-39  
~~\$300~~



31,000 frequencies  
200 channels  
HyperScan  
10 Channel  
Monitor bank  
Back light LCD  
Memory backup  
circuit

5 YRS. WARRANTY AVAILABLE  
CALL FREE: 1-800-433-SAVE

**FORT WORTH COMPUTERS**  
ESTD 1981

Fort Worth Computers  
377 Plaza, Granbury, Tx. 76048

# BEAMING IN

BY TOM KNEITEL, K2AES

## AN EDITORIAL

### Hacking A Wonderful Time

**Y**ou say someone overheard your cordless phone conversation and learned your bank account number? Ho boy!

You claim that despite a federal privacy law, your cellular call was monitored by someone who told your boss you said he was a skinflint? Whoa, but who cares?

You tell me that some 16 year old got your company computer's security password from a BBS, then used it to open a \$5,000 credit line charge account for himself? Hey, I'm all choked up.

Every couple of years a few computer hackers get caught and are written up in the newspapers. That triggers yet another round of astonished revelations on the tabloid TV shows. The indignant show hosts act mortified at learning some of the computer files that hackers have been able to invade. This invariably includes financial and educational records, court and police information, scientific data, and national defense data.

This ritual of hacker discovery takes place regularly happens every two or three years. Each time it's as if none of these practices had ever before been made known to the public.

We are asked to have limitless pity for the poor owners of those computers whose private and sacred data has been ruthlessly violated at the hands of marauding cyberpunks with their evil computers.

Another round of this drivle appears to be in progress now. I recently saw a replay of the entire scenario, right down to Geraldo Rivera on TV discussing computer hackers. With a face of stony seriousness, it was as if he had personally discovered the first young hacker ever captured alive and forced to confess his many sins in front of a TV camera. Personally, I thought the hacker came across a lot better than did Geraldo.

Despite this continuing negative public relations campaign to keep the world living in dread fear of hackers, I'm still not sold on the need to immediately sign up for the tar-and-feather brigade. In fact, methinks I smell a red herring. I'm beginning to suspect that all of this media coverage consists of nothing more than the chintziest possible way of finding convenient scapegoats to blame for the failure of the nation's data security systems.

(continued on page 74)

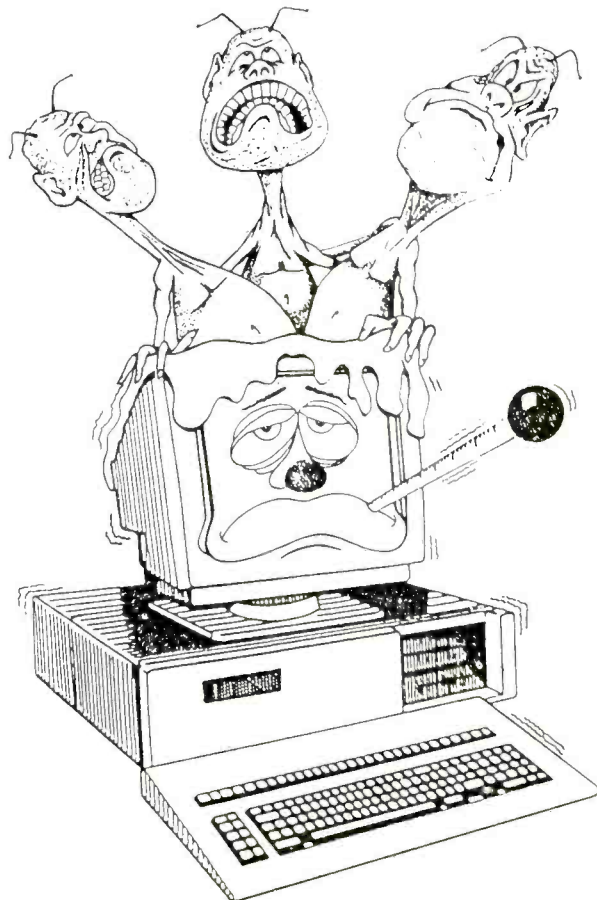

# HIT THE ROAD WIDE OPEN

## A MUST FOR SHORTWAVE LISTENERS

The Philips DC 777 packs a sophisticated AM/FM/Shortwave (SW) tuner, cassette player and powerful amplifier into a single compact car stereo unit. The DC 777 can be fitted into cars, trucks, mobile homes or boats, providing access to the world of shortwave from almost any location. The DC 777 covers the shortwave frequencies from 3170 kHz to 21910 kHz (13 to 90 meter bands).

## 20 DIGITAL PRESETS & A NARROW IF BAND

Program up to 5 frequency settings on each of the four presets. You can then run through the frequencies to select the best reception. Philips also incorporates a narrow IF band to counter transmitter problems. When the treble control is set to its lowest level, shortwave sound quality is optimized and the IF band is automatically switched to a higher selectivity level.

## SUPERIOR SOUND

The Philips DC 777 features 50 Watts RMS for superb quality sound with low distortion and extended frequency response. It also has an Audio Super Control (ASC), which makes it possible to compensate for the variation in sound between different radio wavebands and the radio and cassette sections.

## AND A HIGH-END CASSETTE DECK TO BOOT

The DC 777 features an autoreverse cassette deck that gives you the convenience of non-stop cassette play, avoiding the necessity of flipping the cassette over when one side is finished. Autostart sets the tape running as soon as it's inserted and radio reception automatically cuts in whenever a tape is being rewound or forwarded.



On November 1, 1992 The World Cup Rally Race will begin in England.

Approximately 3 weeks later, the cars will cross the finish line in Dakar, Senegal.

During this torturous race, the only U.S. entry, car driver Don Dixon, will need to stay in touch with the rest of the world.

His choice for a car radio - the most unique one in the world - the Philips DC 777 AM/FM/Shortwave cassette stereo.

Even if you're not racing around the world, the Philips one-of-a-kind DC 777 is the only car radio you need to stay in touch with the world.

To find out how to buy the Philips DC 777 for yourself, call

# 1-800-524-6638

# MAILBAG

## LETTERS TO THE EDITOR

Each month we select representative reader letters for our Mailbag column. We reserve the right to condense lengthy letters for space reasons. All letters submitted for consideration must be signed and show a return address. Upon request, we will withhold sender's name should the letter be used in Mailbag. Address letters to Tom Kneitel, Editor, Popular Communications Magazine, 76 North Broadway, Hicksville, NY 11801.

### Only One "Correct" Opinion Allowed?

I was disappointed to read the negative comments regarding religious broadcasters in the April issue (page 10). The reference to a religious format "as close to going dark as a station can get without actually pulling the switch" was inappropriate in the feature by Alice Brannigan. My employer, KCRO-AM, does not consider their format as one step away from shutting off the transmitter and going out of business. There are many suc-

cessful religious broadcasters, both commercial and non-commercial, so to say that the format is "very bland" and a last resort is an insult to those of us who work very hard in this part of the broadcast industry.

Vern J. Wirka, Chief Engineer,  
Station KCRO,  
Omaha, NE

You have every right to form positive opinions regarding this type of programming format. In that you earn your livelihood with this format, you should certainly freely express those opinions. But, I'm not sold on the concept that it's fair for you to label as "inappropriate" those opinions that happen to differ from yours, nor for you to claim that opposing opinions are "an insult." Shouldn't others have the same right you do to form and express their opinions? Are we heading towards a "one opinion" society? Our author's opinion was based upon WCAO having once been a great "boss" rock station with 20-share ratings. At the point last November when every WCAO air personality was fired and a gospel format was instituted, many who remembered what WCAO once was were dismayed. These people were entitled to

form a negative opinion of WCAO's present programming that is neither inappropriate nor an insult. Furthermore, our story did not pick on the religious format, in particular, as being "very bland," as claimed in your letter. The story observed only that there are six former rock music AM'ers in Baltimore "that are either dark or else have been forced into other formats that, by comparison, seem very bland." These other formats include all talk, as well as many types non-rock music. In fact, WCAO did actually appear to have been forced into the gospel format as a last resort when its ratings sagged to a 1 share, even after trying a country music format. Incidentally, we would really have enjoyed receiving at least one letter of appreciation from you in response to our recent extensive coverage of religious broadcasters HCJB and WCSN, as well as our frequent positive mentions of other religious stations. —Editor.

### Is Anyone Out There?

At least two years ago, you mentioned a proposed new NASA effort to listen to the cosmos for radio signals generated by civilizations elsewhere in the universe. You haven't mentioned it since. Does the new attempt differ from previous attempts? Did it begin yet?

Bill Wheaton,  
Naples, FL

There have been more than fifty SETI (Search for Extraterrestrial Intelligence) listening searches already tried. Each has been directed towards a specific small area of the cosmos. The new program that we mentioned here a while back has been in the planning and preparation stages for a long time, and should be starting soon. Taking up to seven years to complete from the time it actually begins, it will be a far more extensive search than has ever before been attempted, utilizing the combined efforts of existing radio telescopes, advanced computer technology, and data processing techniques. These combined technologies now make it possible to automatically scan through millions of channels per second and sweep the entire sky for signals that might be sent out by an intelligent society. The upcoming SETI project contains two types of searches. The "Target Search" will examine almost 800 solar type stars within 80 light years of Earth. This effort will scan 1 GHz to 3 GHz, with 1 Hz resolution, which is billions of times more comprehensive than all previous SETI searches combined. The "Sky Survey" will search the entire sky from 1 GHz to 10 GHz, with 30 Hz resolution. This will be 300 times more sensitive than previous Sky Surveys, and be the most detailed systematic radio examination ever conducted of the cosmos. —Editor.



### MICRO-CHOKE™ grabs those 800MHz signals you've been missing.

Antenna Specialists all-band scanner antennas, with our exclusive MICRO-CHOKE, offer pinpoint resonance at 800MHz and excellent performance from 25 to 1000MHz. Now—base or mobile—all police, fire, emergency and other FM communications (even portables) are within earshot. Start hearing more by sending for the FREE 16-page A/S Personal Communications Antennas catalog today!

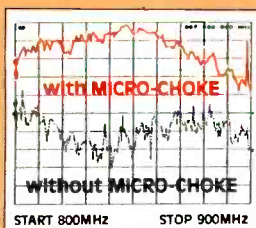

Tenfold signal  
Improvement at 800 MHz!



MON-53 Mobile  
Roof/Deck-  
Mount Antenna



MON-52 Mobile  
Trunk Lid  
Mount Antenna



MON-58 Base  
Station Antenna

### the antenna specialists co.

30500 Bruce Industrial Parkway • Cleveland, OH 44139-3996  
TEL: 216/349-8400 • FAX: 216/349-8407

© Copyright 1990 by The Antenna Specialists Co.

a member of The Allen Group Inc.



CIRCLE 115 ON READER SERVICE CARD



**Now, You Can Eavesdrop On The World.** Introducing the new Drake R8 Communications Receiver. It's world class, world band radio, made in the U.S.A. From Perth to the Persian Gulf, Moscow to Mozambique, local or global, you hear events *as they happen* with amazing clarity. Since 1943, Drake



has been setting the standards in electronic communications . . . and then raising them. Today, there's no better shortwave receiver than the Drake R8. **Out-Of-This-World Performance.** The new Drake R8 has more standard features than other shortwave radios. You get wide frequency range (100 KHz to 30,000 KHz), coverage of all world and local bands, and excellent dynamic range. But you also get important features you won't find on receivers costing hundreds of dollars more. A multi-voltage power supply. Pre-amp and attenuator. Five bandwidth filters and synchronous detector. Dual mode noise blanker and passband offset. Non-volatile 100 channel memory. All designed to give you the best reception with the least distortion. **Down-To-Earth Design.** The ergonomic design of the R8 gives you real ease of operation. You have convenient keypad entry, with large, legible controls. The face is bold. Uncluttered. And the liquid crystal display (LCD) is backlit for easy reading. **Try The R8 . . . At Our Risk.** If you're not impressed by Drake's quality, performance and ease of operation, return the R8 Receiver within 15 days and we'll refund your money in full, less our original shipping charge. For more information, or to order, call **TOLL-FREE, 1-800-9-DRAKE-8**. Telephone orders may be placed on a major credit card. \$979.00 (Shipping and handling \$10 in continental U.S. Ohio residents add 6½% tax.) Call **TOLL-FREE, 1-800-9-DRAKE-8** today. You can't lose.

**DRAKE**

*In touch with the world.*

R.L. Drake Company • P.O. Box 3006 • Miamisburg, Ohio 45342 U.S.A.

CIRCLE 50 ON READER SERVICE CARD



# NRD-535D

*"Best Communications Receiver"*

World Radio TV Handbook 1992



*"Unsurpassed DX Performance"*

Passport to World Band Radio 1992

Setting the industry standard once again for shortwave receivers, the NRD-535D is the most advanced HF communications receiver ever designed for the serious DXer and shortwave listener. Its unparalleled performance in all modes makes it the ultimate receiver for diversified monitoring applications.

Designed for DXers by DXers! The NRD-535D (shown above with optional NVA-319 speaker) strikes the perfect balance between form and function with its professional-grade design and critically acclaimed ergonomics. The NRD-535D is the recipient of the prestigious World Radio TV Handbook Industry Award for "Best Communications Receiver."

**JRC** *Japan Radio Co., Ltd.*

Japan Radio Company, Ltd., New York Branch Office - 43C Park Avenue (2nd Floor), New York, NY 10022, USA Tel: (212) 352-1180 / Fax: (212) 319-5227

Japan Radio Company, Ltd. - Akasaka Twin Tower (Main), 17-22, Akasaka 2-chome, Minato-ku, Tokyo 107, JAPAN Tel: (03) 3534-8836 / Fax: (03) 3584-8778

- Phase-lock ECSS system for selectable-sideband AM reception.
- Maximum IF bandwidth flexibility! The Variable Bandwidth Control (BWC) adjusts the wide and intermediate IF filter bandwidths from 5.5 to 2.0 kHz and 2.0 to 0.5 kHz—continuously.
- Stock fixed-width IF filters include a 5.5 kHz (wide), a 2.0 kHz (intermediate), and a 1.0 kHz (narrow). Optional JRC filters include 2.4 kHz, 300 Hz, and 500 Hz crystal type.
- All mode 100 kHz - 30 MHz coverage. Tuning accuracy to 1 Hz, using JRC's advanced Direct Digital Synthesis (DDS) PLL system and a high-precision magnetic rotary encoder. The tuning is so smooth you will swear it's analog! An optional high-stability crystal oscillator kit is also available for  $\pm 0.5$  ppm stability.
- A superior front-end variable double tuning circuit is continuously controlled by the CPU to vary with the receive frequency automatically. The result: Outstanding 106 dB Dynamic Range and +20 dBm Third-Order Intercept Point.
- Memory capacity of 200 channels, each storing frequency, mode, filter, AGC and ATT settings. Scan and sweep functions built in. All memory channels are tunable, making "MEM to VFO" switching unnecessary.
- A state-of-the-art RS-232C computer interface is built into every NRD-535D receiver.
- Fully modular design, featuring plug-in circuit boards and high-quality surface-mount components. No other manufacturer can offer such professional-quality design and construction at so affordable a price.

# Scanning Mall Security Forces

## Monitor The Private Police Security Forces Patrolling Large Malls

BY CHUCK ROBERTSON

In bygone days, every community had a town square. That grew into a downtown area. More recently, this concept has evolved into what is called the Shopping Mall—an enclosed mini-city of stores that may contain banks, theatres, restaurants, video arcades, miniature golf courses, spas, kiddie rides, and other delights, including hotels.

Malls attract people of all ages and circumstances. Adults like their convenience and park-like setting, also the ability to access many types of stores in one place, and in a climate controlled environment. Senior citizens can shop, window shop, meet their friends, and get some pleasant walking exercise even in the worst rain, snow, or baking summer heat. Teen-agers can hang out, which is what they like to do in malls.

Such a conglomeration of stores and people also attract trouble in its many forms, and that means from inside the stores themselves to right out in the parking lots. This includes shoplifting, pickpocket problems, vandalism, assault, drug dealing, employee pilferage, prostitution, purse snatching, robberies, rapes, muggings, fights, public drunkenness, rowdy groups, trespassing in private areas, and car thefts. There is lost property and there are lost kids, plus animated customer disputes to handle. Of course there are medical emergencies. And there are accidents of all types, especially regarding vehicles. Sometimes there are fires.

Mall managements don't enjoy discussing all such things in public, even though many of the problems are increasing in number. They would prefer that the image of their beautiful shopping centers not be tarnished with ugly and mundane crime stats and images. Yet, crime and trouble are daily facts

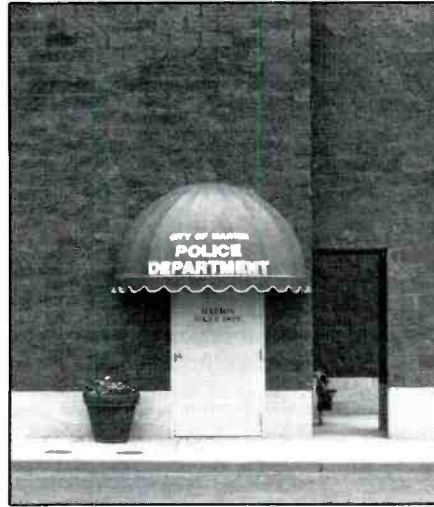

Some malls include police sub-stations. This one at the Illinois Centre Mall, Marion, Ill., operates on 154.965 MHz.

of life at all malls, so they maintain their own private uniformed and plainclothes security forces to try to keep the peace as much as possible. They also have fire safety and emergency medical personnel.

Being privately owned, malls in many areas are not regularly and routinely patrolled by local police departments—although police will show up when called and requested to do so for a particular reason, such as to investigate a felony or make an arrest. But even where local police do regularly patrol malls, their presence is seldom of sufficient magnitude to adequately meet the full security needs of these facilities. Hence the private security forces.

Some malls don't want local police on their property, and will handle all problems themselves including transporting those they arrest to the police station. On the other hand, the new mall in Marion, Illinois, was built to include a local police sub-station. The developers provided the office space and equipment.

Mall security forces are well run and highly efficient, like mini-police departments. In fact, often their personnel include retired and/or moonlighting police officers, or off-duty MP's. The security forces may be directly operated by individual malls, or they may be so-called "rent-a-cops" under contract from guard agencies. The shoulder patches and badges spell out where they're from. Wherever, these forces invariably have their own communications systems, and if you have a scanner then, you have something new to monitor.

A small strip mall might have only one contract guard on part time duty. A large mall can have a large, permanent, full-time, security force comprised of well-trained professionals, and run by the mall management.

### Have A Mall!

With the exception of Tennessee, all states require malls to maintain a security contingent. Only Maryland automatically grants mall security officers any degree of what might be termed "police powers." Instead, most mall security forces derive their powers from the common law doctrine of "citizen's arrest." That is to say, they really don't have any more authority to stop, question, or search an individual than the average citizen does.

The fact that the owner of private property has instructed his or her security officers to



The law requires that malls maintain security, paramedic, and fire detection personnel on staff. This mall, in Marion, Illinois, runs its security operations on 464.875 MHz.



Within large malls, individual department stores may have their own separate security forces, in addition to those operated by the mall in which the store is situated.

enforce certain rules within the confines of that property may grant those forces some limited authority over visitors, but not much. For the most part, mall forces hope that potential criminals will be spooked by their high visibility uniforms, badges, handcuffs, radios, and sometimes pistols. When crimes do occur, the usual practice is for police to be quickly called in.

Mall security officers have sometimes gotten a bit carried away with their jobs, probably due to a combination of zeal and inadequate training. This has resulted in lawsuits for false arrest, unlawful detention, and similar affronts to the public.

Security in larger malls goes on around the clock, and night security may (additionally) involve the services of a central station alarm company. Listen for central station alarm comms in the 460.8875 to 461.0125 MHz band (12.5 kHz steps).

## Shopping For Frequencies

Most mall security forces have communications systems established in the commonly used business bands. Especially check the following bands: 151.625 to 151.955 MHz; 154.515 to 154.60 MHz; 457.5125 to 457.6125 MHz; 460.65 to 462.1875 MHz; 462.75 to 462.775 MHz; 463.20 to 464.9875 MHz; 465.65 to 467.1875 MHz; 467.75 to 467.925 MHz; 468.20 to 469.975 MHz; and 851.0125 to 865.9875 MHz.

A sampler listing of some malls around the nation is provided with this report to give you a basic feeling for the frequencies and bands used.

## Malls Well That Ends Well

Mall management frowns upon patrons bringing scanners inside to monitor the securi-

ty forces. They're entitled to their preference. People who bring handheld scanners into malls might wish to keep a low profile and not blast the audio too high. The security people could still try to offer hassle.

They will usually say that you are on private property and that the management doesn't allow scanners. But wait—let the guards know that the US Supreme Court has ruled that shopping malls are "public meeting places," and not private property in the purest sense. The more a property owner opens up his/her property for general public access, the more his rights are reduced by the statutory and constitutional rights of those who use the property.

The holidays always bring increased activity at malls. That means increased security, and beefed-up security forces. Program your scanner for your area malls and add a new dimension to your monitoring.

### Shopping Mall Frequency Sampler

Northway Mall, Anchorage, AK: 461.775 MHz.	Columbia Mall, Gr. Forks, ND: 463.60 MHz.
Century Plaza, Birmingham, AL: 464.875 MHz.	Southridge Mall, Freendale NE: 464.525 MHz.
Belair Mall, Mobile, AL: 464.875 MHz.	The Mall, N. Platte, NE: 461.425 MHz.
Montgomery Mall, Montgomery, AL: 466.0625 MHz.	Foxrun Mall, Newington, NH: 463.975, 464.225 MHz.
Paradise Valley Mall, Phoenix, AZ: 464.375 MHz.	Pheasant Lane Mall, Nashua, NH: 464.95 MHz.
Foothills Mall, Tucson, AZ: 464.575 MHz.	Ocean One Mall, Atlantic City, NJ: 461.90 MHz.
Metrocenter, Phoenix, AZ: 464.475 MHz.	Mall at Short Hills, NJ: 464.825 MHz.
Valley Plaza Shopping Center, Bakersfield, CA: 154.57	Fashion Plaza, New Brunswick, NJ: 464.475 MHz.
Topanga Plaza, Canoga Park, CA: 154.54 MHz.	Park Lane Mall, Reno, NV: 464.05 MHz.
Century City Center, Los Angeles, CA: 461.025 MHz.	Northway Mall, Colonie, NY: 461.6875 MHz.
Center Points Mall, Oxnard, CA: 464.475 MHz.	Roosevelt Field, Mineola, NY: 462.725 MHz.
Embarcadero Center, San Francisco, CA: 854.8375.	Sunrise Mall, Massapequa, NY: 151.865, 464.465 MHz.
Crossroads Mall, Boulder, Co: 468.7875 MHz.	Cross County Cntr., Mt. Vernon, NY: 154.57, 154.60
Lakeside Mall, Denver, CO: 464.375 MHz.	Gateway Plaza, New York, NY: 464.825 MHz.
Northeast Plaza, Hartford, CT: 464.375, 464.675,	Smithaven Mall, Lake Grove, NY: 154.60 MHz.
464.80, 464.95 MHz.	Northland Mall, Columbus, OH 463.625 464.925 MHz.
Fair Mall, Danbury, CT: 464.675 MHz.	Randall Park, Cleveland, OH: 461.425 MHz.
Montgomery Mall, Washington, DC: 463.25 MHz.	Southern Park Mall, Youngstown, OH: 461.50 MHz.
Renaissance Plaza, Washington, DC: 463.375 MHz.	Woodland Hills Mall, Broken Arrow, OK: 461.075,
Gateway Mall, Jacksonville, FL: 461.025 MHz.	469.675 MHz.
So. Dade Plaza, Miami, FL: 461.675 MHz.	N. Park Mall, Okla City, OK: 464.7875 MHz.
So. Port Square, Ft. Charlotte, FL: 154.54 MHz.	Gateway Mall, Eugene, OR: 461.125 MHz.
Tallahassee Mall, FL: 461.20, 463.60 MHz.	Washington Sq. Mall, Portland, OR: 464.475 MHz.
W. Shore Plaza, Tampa, FL: 461.9125 MHz.	Granite Run Mall, Media, PA: 464.325 MHz.
Piedmont Center, Atlanta, GA: 464.525, 464.5875 MHz.	Century III Mall, Pittsburgh, PA: 464.325, 464.375,
Peachtree Center, Atlanta, GA: 461.825 MHz.	464.975 MHz.
Century Park Plaza, Pearl City, HI: 464.225 MHz.	Parkway Center Mall, Pittsburgh, PA: 464.6875 MHz.
Merel Hay Mall, Des Moines, IA: 154.54, 154.57 MHz.	Condada Plaza, San Juan, PR: 462.925 MHz.
Southridge Mall, W. Burlington, IA: 464.675 MHz.	Plaza Los Americas, San Juan PR: 462.025, 463.475,
The Center, Springfield, IL: 464.775, 464.925 MHz.	463.575, 464.925 MHz.
Ford City Center, Chicago, IL: 154.57, 464.975 MHz.	Mall at Newport, RI: 461.575 MHz.
Fox Valley Center, Aurora, IL: 464.675 MHz.	Columbia Mall, Columbia, SC: 462.1125 MHz.
Glenbrook Square, Ft. Wayne, IN: 464.575, 464.875	Westgate Mall, Spartanburg, SC: 151.955 MHz.
Lafayette Square, Indianapolis, IN: 461.025 MHz.	E. Town Mall, Knoxville, TN: 463.3375 MHz.
Manhattan Tower Ctr., Manhattan, KS: 463.525 MHz.	Mall of Memphis, TN: 464.975 MHz.
Bannister Mall, Kansas City, KS: 464.575, 464.675 MHz	BelleVue Center, Nashville, TN: 464.825 MHz.
Fayette Mall, Lexington, KY: 462.1125 MHz.	Wonderland Mall, San Antonio, TX: 467.875, 469.9125.
Oxmoor Center, Louisville, KY: 464.8125.	World Trade Center, Dallas, TX: 464.375, 464.875
World Trade Center, New Orleans, LA: 463.25 MHz.	Plaza Fort Worth, TX: 461.85, 464.55 MHz.
Mall St. Vincent, Shreveport, LA: 464.675 MHz.	W. Oaks Mall, Houston, TX: 462.1125, 464.3875,
Emerald Sq. Mall, N. Attleboro, MA: 461.725 MHz.	464.4875 MHz.
World Trade Center, Boston, MA: 461.9125, 461.9375,	Crossroads Plaza, Salt Lake City, UT: 464.825,
461.9625, 462.1625, 464.80 MHz.	464.975, 464.9875 MHz.
Arsenal Mall, Watertown, MA: 464.95 MHz.	Southpark Mall, Colonial Hts., VA: 855.5625 MHz.
Copley Plaza, Boston, MA: 154.60 MHz.	Coliseum Mall, Hanpton, VA: 464.30 MHz.
Eastpoint Mall, Baltimore, MD: 151.805 MHz.	Tower Mall, Portsmouth, VA: 464.675 MHz.
Beltway Plaza Mall, Greenbelt, MD: 151.925 MHz.	Southgate Mall, Milwaukee, WI: 464.725, 464.8875 MHz.
Briarwood Mall, Ann Arbor, MI: 462.05, 462.575 MHz.	Grand Central Mall, Vienna, WV: 151.835 MHz.
Renaissance Center, Detroit, MI: 151.955, 462.60,	Frontier Mall, Cheyenne, WY: 464.5125 MHz.
462.7625 MHz.	Toys R Us, nationwide: 461.7375, 461.9625 463.7875,
Woodland Center, Grand Rapids, MI: 464.475, 464.5375	464.9625 MHz.
Center Place, Rochester, MN: 462.125 MHz	J. C. Penney, nationwide: 154.57, 154.60, 461.6125,
Signal Hill Ctr., W. St. Paul, MN: 464.4375 MHz.	461.9375, 464.50, 464.55 MHz.
Banister Mall, Kansas City, MO: 464.575, 464.675 MHz.	K-Mart, nationwide: 154.57, 154.60, 457.5375,
St. Louis Galeria, Richmond Hts., MO: 461.9125,	457.5875, 461.3125, 463.9125 MHz.
462.0875, 462.8625 MHz.	Montgomery Ward, nationwide: 467.8125 MHz.
Mall at Barnes Cross, Tupelo, MS: 464.60 MHz.	Zayer, nationwide: 461.0125, 463.4125 MHz.
W. Park Plaza, Billings, MT: 464.775 MHz.	Sears Roebuck, nationwide: 154.57, 454.50, 464.55 MHz
N. Hills Mall, Raleigh, NC: 464.575 MHz.	Wal-Mart, nationwide: 151.625, 467.7625, 467.75,
Independence Mall, Wilmington, NC: 464.7875 MHz.	467.775, 467.80, 467.825, 467.85, 467.875, 467.90.

# Radio: The Good Old Days

## Return To Those Thrilling Days Of Yesteryear

BY ALICE BRANNIGAN

**T**he Foreign Broadcast Information Service (FBIS) started out in 1940 as a branch of the FCC. During World War II, the FBIS monitored foreign radio broadcasts and provided the U.S. Government with a principal source of foreign intelligence.

Utilizing one of the world's most elaborate receiving networks, FBIS monitors intercepted, recorded, then translated, summarized, and prepared reports on the wartime broadcasts of many nations. Monitored information was processed through major FBIS domestic receiving installations at Hayward, Calif., Silver Hill, Md., and Portland, Oregon. Outside the continental U.S., there were listening posts in Iwo Jima, Guam, Kauai, London, and Cairo. If you think that this sounds like a dream job for a communications hobbyist, you'd be right. Most of the FBIS wartime monitors were hams.

Our government originally undertook the monitoring of foreign broadcasts as a result of the expansion of broadcast facilities that had started several years before the war and was developed even further during the course of the conflict.

During the war, monitoring of foreign broadcasts was used by the government (1) as a listening device to report quickly and accurately the reaction of foreign governments as expressed through their official or semi-

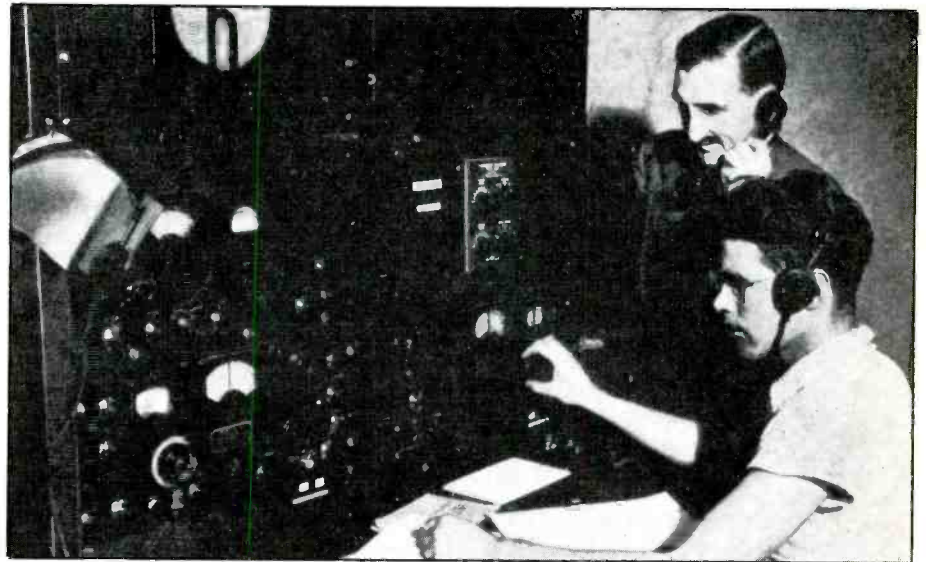

*This WWII monitoring post shows the popular Hallicrafters SX-28 communications receivers in operation.*

official radio to broadcasts from nations of the Allies, and to report the content, trends, and probable intent of broadcasts beamed to Allied nations. Then (2), as a collecting device to report the large volume of intelligence intercepted about conditions and develop-

ments in various nations. Inasmuch as the monitored broadcast data could be added to other intelligence information to supplement that information.

The FBIS operated day and night, around the clock. It distributed the significant content

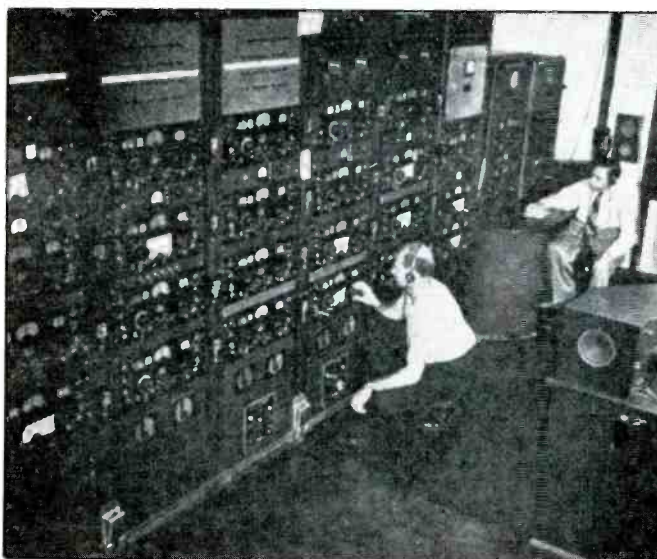

◀ *In this official FBIS photo, the bank of receivers in the racks are assigned to monitor specific frequencies. The operator seated at the desk (photo right) has his own receiver that he uses to tune around seeking out new active frequencies.*

▶ *Part of the elaborate FBIS antenna system at the Silver Hill monitoring station in this official FBIS photo.*

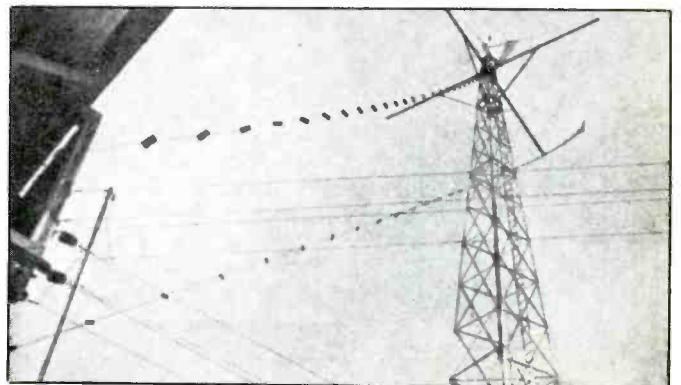

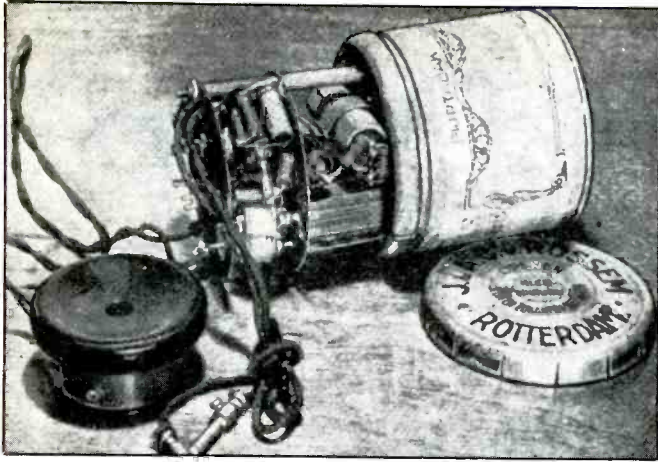

A receiver used by Dutch citizens during WWII. Because radios were forbidden by the Nazi captors, these radios were constructed in innocent looking objects. This one is built in a tobacco tin.

from more than five million words of broadcast material each day. Distribution was by a wire circuit to all principal government offices in Washington, also by mimeographed copy, and through various reports and publications. The principal users were the State, War, and Navy Departments, Foreign Economic Administration, UNRRA, Federal Reserve Board, the Dept. of Justice, Office of War Information (OWI), British Ministry of Information, Canadian Wartime Information Board, the Philippine Mission, and the Chinese Embassy.

One of the more interesting aspects of FBIS operation, from a monitoring standpoint, was keeping accurate track of the current status of many target broadcasts. A master index was constantly revised, containing frequencies, schedules, languages, station informa-

tion, and program type. It usually ran to 6,000 listings. Some FBIS monitors were free to tune around at random seeking out new, unlisted, stations and programs. All intercepts were meticulously logged.

In order to do the actual monitoring, the primary receiver of choice was the Hallicrafters SX-28. Hundreds were in use by the agency, with each maintained in top shape. An external crystal frequency standard could keep the receivers' analog tuning calibrated at 100 kHz points.

The antennas used by FBIS monitors were directional rhombics, each covering a 20 degree arc. Each antenna could be switched to any of the receivers in use.

Recordings were made on paper-based discs and on wax cylinders, and typewritten transcripts were also made of the broadcasts,

in addition to the recordings.

The FBIS was considered one of the government's most effective non-military wartime operations. But by late September of 1945, with the war over, the FCC was told that the 350 FBIS employees would no longer fit into the agency's budget, which was being cut by \$930,000 to a peacetime level. During the war years, the FBIS had cost \$1,500,000 annually.

The FBIS was eventually absorbed into the CIA, which expanded its operation with additional monitoring stations in Cyprus and a number of other overseas locations. Furthermore, a series of FBIS shortwave frequency directories were eventually published by the U.S. Government.

This was a really interesting shortwave broadcast monitoring activity, but it seems to

A 1945 view of the studios at VPD2, Suva, Fiji. The station ran 500 watts on 6135 MHz and was widely reported throughout the USA and Canada.

Holland's famous pioneer shortwave station PCJ was built by the Philips Radio Co. at their factory in Eindhoven, and installed at their facilities there. During WWII, the Philips works were taken over by the Nazis. During Allied air raids, Dutch citizens liked to sneak into the factory and appropriate the parts needed to build their receivers. This 1939 veri shows the twin PCJ masts mounted on a rotatable base.

**PCJ HILVERSUM HOLLAND**

wish to convey to you their appreciation of your kind communication regarding the experimental transmission on behalf of Philips Radio Works, Eindhoven, Holland, on 52° 17' 32" N latitude and 5° 11' 48" E longitude.

Frequency 15220 kc. Wavelength approx. 19.71 m.  
9500 kc. Wavelength approx. 31.58 m.

Power Two Philips Tubes  
Free I.A. 20/250 on the final stage.

Position Lat. 52° 17' 32" N — Long. 5° 11' 48" E

Announcements in NETHERLANDS - ENGLISH  
FRENCH - GERMAN - SPANISH and PORTUGUESE.

**FBC**

Some street scene.

**FIJI BROADCASTING COMMISSION**

GLADSTONE ROAD, SUVA, FIJI. BOX 334. CABLES: "BROADCOM".

The Fiji Broadcasting Commission sent out these QSL's 25 years ago for Radio Fiji on 6005 kHz. Fiji no longer broadcasts on shortwave.

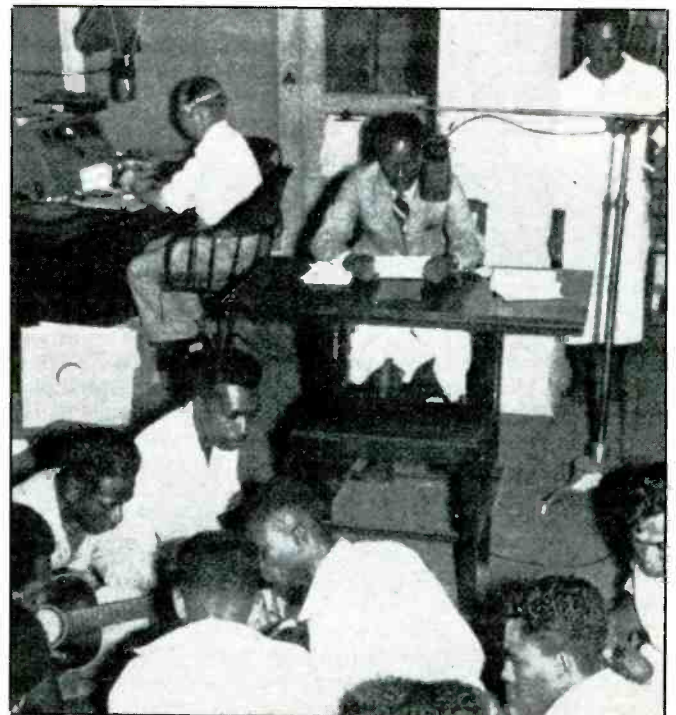

# ELIMINATES SEARCHING, SCANNING, TUNING INTERCEPTOR™

INTERCEPT, DETECT & CAPTURE  
Near Field Transmissions with  
Optoelectronics' New  
INTERCEPTOR™



MADE IN THE U.S.A.

## NEW TECHNOLOGY

- Follows & Locks on even when frequency changes.
- Intercepts ALL FM Two-Way Transmissions without gaps in coverage.
- Does Not have to tune through RF Spectrum to find signals.

## FCC Classified as Communication Test Instrument for:

- Deviation, FM, FMN
- Relative Signal Strength
- Signaling Tones (CTCSS)
- Modulation Monitor
- Great for testing VHF, UHF & Cellular transmitters

## A New Dimension in Recreational Monitoring – Intercept the Two-Way Communication that Surrounds You.

Increase Your RF Security.



Hand Held/Shirt Pocket Size

**INTRODUCTORY OFFER**  
**Interceptor™ R10 FM Communications**  
 Interceptor (Includes NiCads, AC/Charger Adapter, Antenna, Earphone) ..... **\$359.**

### OPTIONS

Headphones (Lightweight personal headphones).....	\$ 15.
Antenna Pak 2 (Five assorted rubber duck antennas – save \$32.).....	\$ 99.
TC200 Tone Counter (CTCSS signalling tones).....	\$ 179.
APS-104 (Extends RF detection distance 10x).....	\$ 995.
CF800 Cellular Band Pass Filter/Amplifier.....	\$ 299.

# OPTOELECTRONICS

FACTORY DIRECT ORDER LINE **1-800-327-5912**

305-771-2050 • FAX 305-771-2052 • 5821 NE 14th Ave., Ft. Lauderdale, FL 33334  
 5% Ship/Handling (Max\$10.) U.S. & Canada. 15% outside continental U.S. Visa & Master Card accepted

# SUPER SENSITIVE scanner antenna

MFJ-1864

**\$79.95**



Your scanner will come alive with signals you never knew existed when you use this new *super sensitive* antenna.

You'll hear distant mobiles -- even handhelds -- as they talk with base stations.

You'll pull in weak ground signals from distant control towers and air-traffic centers -- even hear *both* sides of conversations!

The MFJ-1864 combines new weak-signal technology -- an *extremely low noise amplifier* -- with a resonant high gain omnidirectional antenna.

You get 20 dB of extremely low noise amplification that'll let you hear signals down to the noise level.

The sensitive high gain antenna operates as two collinear 5/8 wave elements fed in phase on the 108-174 MHz aircraft/VHF high bands and as resonant halfwave elements on 30-50 MHz VHF low band.

For really long range reception, you can mount your antenna up extra high outdoors in the clear and feed it with long runs of inexpensive coax.

Coax loss won't degrade your signal. That's because weak signals are amplified at the antenna *before* going into your coax.

Sidemounts to your existing tower, TV mast or any 1 to 1 1/2 inch pole with one U-bolt (supplied). 8' high, 2' boom. \$7 S/H.

## MFJ high-gain narrow-band specialized antennas outperforms broadband antennas



### For Handheld Scanners

**A. Long Ranger™**, MFJ-1714, \$16.95. Super long range reception on 118-174 MHz VHF high-band. 40" extended, 10 1/2" collapsed.

**B. Dual Bander™**, MFJ-1712, \$14.95. 5/8 wave gives maximum gain 406-512 MHz. 1/4 wave 118-174 MHz. 19" tall, 7 1/4" collapsed.

**C. MFJ Pocket Roll-Up™**, MFJ-1730, \$14.95. Roll up this high gain J-antenna and stick it in your pocket! Hang it up for base station performance. Highest gain on 118-174, 406-512 MHz. 58" plus coax.

**D. "Shorty" Duck** MFJ-1718, \$12.95. 4 1/2" Hi-Q super efficient replacement rubber duck.

### For Mobile Scanners

**E. Maximum Gain 5/8 Wave™**, \$29.95. Gives maximum gain of any single element mobile antenna on 108-174 MHz. Resonant 1/4 wave on 30-50 MHz. 48", magnet mount. MFJ-1828B. BNC: MFJ-1828M. Motorola.

**F. All Band Mobile**. \$19.95. Cellular look-a-like. 25-1300 MHz highest gain 406-512, 108-174 MHz. 19". Magnet mount. MFJ-1824BB. BNC: MFJ-1824BM. Motorola.

**Nearest Dealer/Orders: 800-647-1800**  
Order from MFJ and try it. If not satisfied return within 30 days from refund (less S/H).

**MFJ** MFJ ENTERPRISES, INC.  
Box 494, Miss. State, MS 39762  
(601) 323-5869; FAX: (601) 323-6551  
Add \$7 each S/H. More outside USA for S/H. © 1992 MFJ.

be largely forgotten today. Certainly worth remembering.

## Speaking of WWII Broadcasts

During WWII, underground and secret radio receivers were built in every occupied European nation. In the Netherlands, they even built a transmitter right under the noses of the Gestapo.

Work was started in early 1944 by three Dutch experts so that the new station would be ready to operate as soon as the Allies reached Dutch territory. The new station was dubbed *Herrijzend Nederland* (Resurgent Netherlands), and the idea was for the transmitter to be powerful enough to cover the entire nation with its signal.

To have started such a big project in one place was risky and would surely have led to discovery long before completion. It was therefore decided to build the transmitter in sections, all hidden at widely scattered locations. Everything had to be done with deliberate secrecy, including the meetings of those who were building the unit, and moving the parts from place to place. The Gestapo was prone to asking too many questions when people were noted as visiting certain houses too frequently. There were several close calls.

By the end of September, 1944, the Netherlands government in London had been secretly informed of the plan. By then, several parts of Holland had been liberated, and the different sections of the transmitter had been assembled. An antenna was strung between two chimneys and the moment of truth had finally arrived.

On October 3, 1944, *Herrijzend Nederland* first went on the air. It worked without a hitch, and was heard throughout Holland -- even in those areas that were still occupied. This station was a great morale boost to the Dutch.

You may wonder what the Dutch citizens were using to hear this station. Radios, of course. The Dutch had secret receivers for hearing the BBC throughout the war.

Typical of one such ingenious Dutch radio was a set that was constructed around a selenium rectifier. The 2-tube AC set had an output transformer to supply the filaments and the small selenium cells for "B" voltage. Four of the cells in series put out sufficient voltage to supply the tubes with more than 65 volts after filtering.

Sets like this were often made to be operated on current from a bicycle generator. The Nazis would cut off the electric power during the hours when the BBC was on, and batteries weren't available. Sets were concealed in lamps, water bottles, candy and tobacco tins, and cracker boxes.

The Nazis had forbidden the Dutch to own radios. The penalty was imprisonment or possibly death. Despite this, in the city of Eindhoven, there were estimates that about 3,000 hidden radios existed. This estimate was based upon the amount of materials taken during air raids from the large Philips

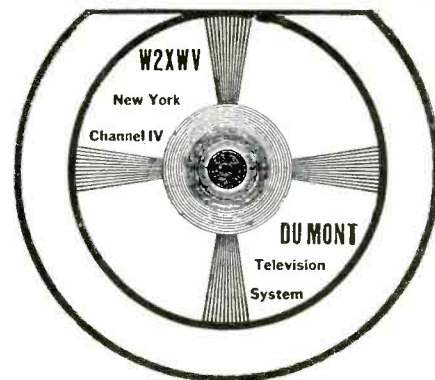

A rare look at an old fashioned 1944 black/white TV test pattern. W2XWV was the experimental callsign for New York's WABD, which operated in 1944 from 78 to 84 MHz, then called Channel 4. DuMont's WABD later operated 76 to 82 MHz (presently Channel 5). It eventually became MetroMedia's WNEW-TV, and is now Fox's WNYW. When color TV came in, most stations dropped these test patterns in favor of color bars.

Radio Co. factory there. It was the only way parts could be obtained during the war. People used to say things like, "Two more air raids and my radio will be ready."

Using the same method for parts requisition during air raids, Dutch patriots also constructed a number of small clandestine transmitters used for communicating with underground fighters and with the British Secret Service. When the Nazis had set up a small quartz saw in a lab at the Philips Radio Co. (which they had taken over), they had unknowingly made many of the crystals used for the transmitters.

## Let's Get Exotic

From the beautiful South Seas, we get a look at VPD2, in Suva, Fiji. A photo we have of this far-away station dates from 46 years ago, and that puts it in the realm of the historic.

Those were the days when VPD2, on

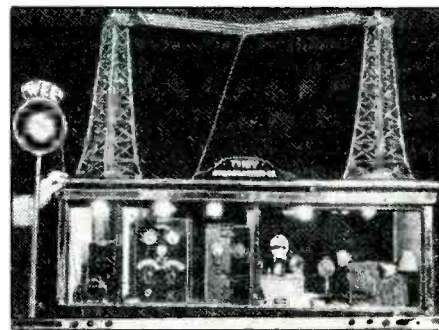

The world's smallest radio station was "WEE," which ran .04-watt, and was located on a tabletop somewhere in Cincinnati. Don't laugh, this mighty mite really worked and was quite the public attraction when it was displayed about 1935.



6130 kHz, was running only 500 watts, although it was authorized for 10 kW. Programs consisted of relays from ZJV on 920 kHz. The intent of VPD2 was to bring ZJV's programs to the outlying islands beyond range of the mediumwave signals. VPD2 was using an omni-directional antenna, and even with its low power was being widely reported across North America, especially those in English.

VPD2 was operated by the Fiji Radio Service, Amalgamated Wireless (Australasia) Ltd., of Fiji. There are now three medium-wave broadcasters in the city of Suva, but they aren't ZJV, and there are no longer any shortwave broadcasters in the entire nation of Fiji.

### High Definition Television

There's been so much hype of late about high definition television (HDTV) of late, it brought up the point that (as usual) everything old is new again.

HDTV with 1050 lines was developed in France and demonstrated in mid-1945 by the Compagnie de Compteurs de Paris. One of those who attended the demonstration was Morrie Pierce, former engineering supervisor of WGAR, WJR, and KMPC, who was just finishing up a two year stint as the Chief Engineer for the Office of War Information (OWI) in Europe and Africa.

The first demonstration consisted of 450-line film and live action TV images projected onto a 4 by 6 ft. screen. These were reported as being of reasonably good quality.

Then there was a 1050-line HDTV system demonstrated on a 15-inch CRT. Picture quality and contrast were described as extremely good, with home movie quality as far away as viewing at six or seven feet, although it was not as good quality as a magazine photo. In comparison, the 450-line quality was compared to a newspaper photo's quality.

All transmissions were by wire, although it was noted that broadcasts were possible but would require between 12 and 15 MHz of bandwidth.

The U.S. rights for the French HDTV system were apparently purchased in 1945 by CBS, which seems to also have simultaneously purchased a number of other foreign patents, including ones covering color TV.

So, as we watch the news for the latest developments in HDTV, we wonder when and where it will end. After all, it's been much longer in arriving than most people think.

### World's Smallest Radio Station?

Last month we told you about super-power WLW when it ran tests with 500,000 watts back in the early 1930's. As a strange contrast to itself, WLW's engineers painstakingly hand-built what they said was the world's smallest radio station.

Built in 1935 as a publicity gimmick, the entire station could fit on a table top. It ran .04-watt, and actually worked. The station used the self-assigned call letters "WEE." For

the most part, WEE was carted around to various public events, and displayed in theatre lobbies. It always attracted a large crowd. A full-sized microphone (emblazoned with the WEE call letters) fed into the transmitter in order to permit visitors to sing or say a few words "over the radio."

The station had two towers on the roof, with miniature studios and other facilities inside. A sign on the small building read "Tiny Broadcasting Co."

Several years ago we mentioned WEE (and ran a different photo). Quite a few letters came in afterwards asking if we could report on the final disposition or present location of this miniature treasure. We had no information on this, but one reader in Cincinnati was then inspired to devote considerable time and effort to trying to learn the disposition of WEE. After several months of investigation, which included checking with WLW, he came up empty.

Our guess is after a year or two of being displayed, it got put into storage. It sat there, and after a while it became dusty, outdated, and forgotten. Eventually it was probably tossed out with a lot of other old stuff deemed useless by people who didn't have any idea what it was all about, or that anybody in the 1990's would care.

That's it for November, but we hope you will join us for our December outing. Send along your old time radio QSL's, photos, stories, station listings, news clippings, and anything else. We did want to give a special mention and huge thanks to Ken Hale, W7VCB, of Raymond, Wash. Ken asked us if we could use some old radio magazines he had lying around. When we said we could, we weren't quite expecting what Ken sent us. Ten large boxes arrived filled with nearly 400 radio and wireless books, magazines, and catalogs dating between the the spark gap era and the 1960's! It's an entire library! *Fantastic!*

# High Tech Satellite Imagery!

**Achieve professional results—often surpassing the capabilities of local TV weather reporting. Plug it into your receiver earphone jack and decode all APT modes—GOES & Polar satellites as well as HF Marine fax. Capture, enhance, print gray scale weather facsimile using your PC. Latest technology for optimal noise rejection, self-test modes, advanced menu-driven software and help windows assure easy operation.**

*FCC Certified*

**LOOK AT THESE FEATURES!**

- All modes: GOES-WEFAX, GOES-TAP, NOAA, Meteor, Meteosat, HF-WEFAX, HF-Marine/C-Band wire photos
- Full satellite pass at full resolution
- 1280x1024 with 256 colors and below
- Temperature calibration & contour maps
- Latitude/longitude grids and "you are here" function
- Unattended operation & 24-hour schedule/timer
- Standard TIFF and GIF file formats
- User-defined palettes, interpolation, zoom, scroll, rotate, reverse, histograms, brightness, contrast, negative, linear/logarithmic enhancement curves.
- Integrated GOES-TAP and WEFAX animation
- Print gray-scale on laser and dot matrix printers

Qty	Price	Total
	\$395	
	\$495	

6404 Lakeside Court  
Raleigh, N.C. 27612  
Telephone: 1-919-847-4545

**OTS WeatherFAX**

Complete kit/software  
Assembled card/software  
Foreign orders - add \$14 shipping  
Total

Half sized card plugs into your PC



Name \_\_\_\_\_  
Address \_\_\_\_\_  
Phone \_\_\_\_\_

## ICOM™ R7000 Sweeping 1300 Channels/Min.

**DELTA COMM™ 1.04** gives you a custom interface and optimized software that will not just control but will maximize the potential of your R7000. Spectrum log at speeds in excess of 1300 channels/min. while automatically generating a histogram of frequency/activity. Advanced priority channel monitoring and program control, by channel, of remote tape recorders during scanning. Here are a few (there are many more) examples of the advanced features DELTACOMM has to offer:

- Birdie log during frequency search automatically characterizes your R7000, then locks out those frequencies
- Auto histogram and scan file creation during spectrum log
- Scan file channel lock-out feature allows scanning around channels without removing that frequency from database
- Resume scan and maximum monitor values unique on each channel scanned
- Each frequency within a scan file has an area (40 characters wide) for channel information
- Auto frequency detection and storage during search and spectrum log
- User friendly installation program reduces need for DOS knowledge
- Full support of serial ports COM1-COM4
- On-screen HELP reduces need to refer to user manual
- REQUIREMENTS: MS-DOS microcomputer with minimum 512K memory. DELTACOMM's performance is proportional to baud rate setting, style of display card and type of computer used.



**\$299** Incl. Ext. Interface & Components for Cabling  
 Check, MO, VISA or MASTER  
 Accepted + \$4 for S&H  
 (WI Res. Add 5% Sales Tax)



**DELTA RESEARCH**  
 PO Box 13677 • Wauwatosa, WI 53213  
 FAX or Phone Weekdays (414) 353-4567

CIRCLE 118 ON READER SERVICE CARD

## ***It's All In The Computer — Ha!***

The amount of information kept on you in computers is staggering: bank transactions, card reports, loan balances, medical records, school transcripts, employment applications and records, pharmacy prescriptions, DMV data about your vehicles and driving record, insurance claims and policies, tax returns, police and court records, public utility bills, real estate holdings, charge accounts, licenses and permits, union membership information ... the list goes on and on. And where there's stored information, there are those who seek to access the data for their own purposes, and usually for considerable profit.

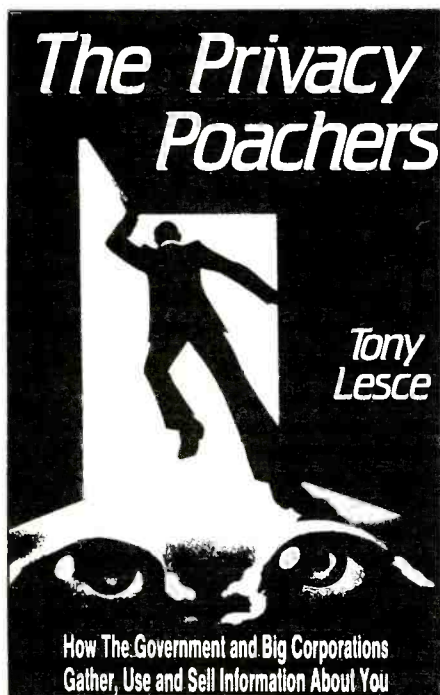

Tony Lesce's 155 page book, *The Privacy Poachers* explains exactly who is collecting information about you and what they're doing with this information. According to Tony Lesce, this includes everybody from the government to private snoops. What is done with the material learned about you from computer data banks? It can be sold as raw data to private investigators, credit bureaus, prospective employers, or others. Or it might be assembled with other information about you such as physical and electronic surveillance, mail monitoring, information provided by your neighbors and co-workers, plus other collected intelligence. What then emerges is a detailed dossier of every aspect of your private life. This information is packaged and sold to some third party, supposedly for a

credit or security check, but who knows for what true purpose. Then it might be sold over and over again, all without your permission or even your knowledge. After a couple of resales, it could end up just about anywhere.

Lesce claims that privacy poachers can have a devastating impact on your life. Many people in New England found out the hard way when a national credit rating bureau incorrectly tagged them as deadbeats. An Arizona man found out when a police computer reacted to his name with the warning, "High Risk: AIDS."

Despite privacy laws, most of which seem to be ineffectual, information about you—including false or damaging items—can be flashed around the world almost instantaneously. Information attributed to you might have been erroneously taken from the records of someone else with a name that's the same as yours, or maybe one very similar. Or, it could simply have been copied incorrectly or misinterpreted from your actual file.

Dipping into people's lives goes deeper than just computer data, says Tony Lesce. Did you know that some companies use genetic testing to pre-screen job applicants? Did you know a car manufacturer recently hired 100 undercover agents to pose as assembly line workers to collect information on co-workers? A technology called "passive monitoring" calls for sensors implanted in a building's walls to record every movement of employees and visitors.

Lesce's book covers the birth of "Big Brother," also who it is that wants to know about you—and why. He discusses how information is collected, and the laws that are supposed to protect you from having your information freely handed out to various snoopers. What about people who get "blacklisted" because of this type of snooping? What about your mail getting opened and read before you even see it? There are chapters on electronic surveillance, business surveillance, and more. There is also information on protecting the data about yourself stored in the computers owned by others.

*The Privacy Poachers* explains that you can exercise control over most of the information collected on you. You do have some legal rights and recourse, and this informative book will let you know how to keep your personal information away from the privacy poachers. We thought the author covered his topic very thoroughly, and wrote about it in a very readable style.

*The Privacy Poachers* is \$16.95, plus \$4 for shipping, from Loompanics Unlimited, P.O. Box 1197, Port Townsend, WA 98368. Residents of Washington State please add 7.8 percent sales tax.

## ***Movin' Along***

Few things are quite as enjoyable as driving along and sampling the different AM and FM radio stations along your interstate route. As you travel, you get a unique opportunity to hear new stations, new call letters, commercials for products and stores you had never before known about. You hear music and speech dialects that expand your awareness, knowledge, and appreciation of the diversity that comprises our wonderful North American community.

This can be done randomly. The technique calls for manipulating the steering wheel with the left hand, then continuously tuning across the AM and FM bands with the right hand in the hope of finding a station.

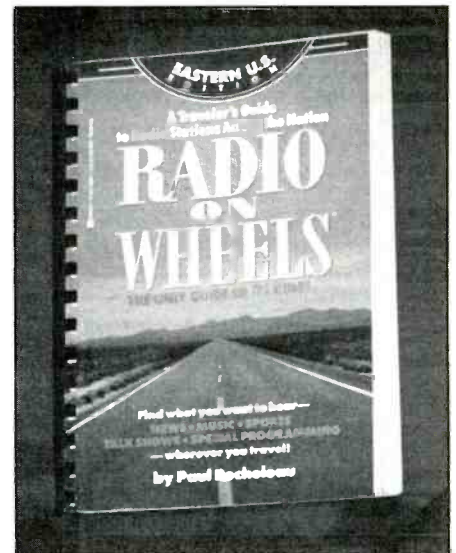

A much better idea is to make the most of the opportunity by knowing which stations are available to hear at any given point along your route on a major Interstate highway. That's the job of two excellent listening guides called *Radio On Wheels*, by Paul Rocheleau. One edition covers the Eastern USA, the other the Western continental USA.

The information is arranged according to major Interstate routes, with stations shown in different cities and towns along those routes. Information provided in the listings shows the frequencies, call letters, program formats, relative signal power, news and traffic bulletin information, and special programming comments for those stations you're most likely to pick up from your vehicle at various points on that particular Interstate. As you travel, you just follow the cities along in the book, as they are arranged in the order you come to them as you travel. Then you

# BIG DEAL

**SMALL PACKAGE - SMALL PRICE**

We're making our biggest deal on the famous Handi-Counter® 3000 — the world's finest hand-held multifunction counter.

- 10Hz - 3GHz
- Maximized Sensitivity
- 16 segment RF signal bargraph
- 4 extremely fast gate times
- 256 times faster than other hand-held counters
- Frequency, period, ratio, time interval, average & prescale
- 10 digit LCD readability even in bright sunlight
- Hold switch locks in measurements fast

Regularly \$375...Now

**\$259**

Deal ends December 31, 1992  
No trade-ins or Dealer discounts



**OPTOELECTRONICS**  
**HANDI-COUNTER**  
**MODEL 3000**  
10Hz-3GHz Universal Handi-Counter

FREQUENCY

146.009328

10

BARGRAPH

ADJ

INPUT  
A/B

GATE

FUNCTION

PWR  
ON

Range  
200MHz

800MHz HOLD

3000MHz

OFF

MADE IN THE USA

9-12VDC

## OPTIONS

TCXO	± .2ppm	\$100.
BLB30	Back light & two step audible signal level indicator	\$ 75.
CC30	Carry Case	\$ 15.
TA100S	Telescoping Whip Antenna	\$ 12.

**OPTOELECTRONICS**

FACTORY DIRECT ORDER LINE **1-800-327-5912**

305-771-2050 · FAX 305-771-2052  
5821 NE 14th Ave., Ft. Lauderdale, FL 33334  
5% Ship/handling (Max \$10) U.S. & Canada.  
15% outside continental U.S. Visa & Master Card accepted

know what to listen for. The books are conveniently spiral bound so they will stay open to the page you want.

In addition to the cities along your route, major metro areas are shown in special close-up sections that list virtually all local stations, including the lower powered broadcasters.

There's a lot of information packed into these big, useful books. The Eastern USA edition has 221 pages, and covers the following states: AL, CT, DC, DE, FL, GA, IN, ME, MD, MA, MI, MS, NH, NJ, NY, NC, OH, PA, RI, SC, TN, VT, VA, WV. The Western USA edition runs 181 pages and covers all of the other states in the "lower 48."

Either edition of *Radio On Wheels* (specify which one you wanted, East or West) is \$8.95, plus \$3.50 for UPS shipping (sent by 1st Class Mail to AK, HI, VI, PR, GU, military addresses and Canada. If both editions are ordered together, enclose \$16.90 (that's a \$1 saving), plus \$4.50 for shipping. Residents of NY State, please enclose \$1.06 tax if ordering one book, or \$1.82 tax if ordering both editions together.

## Serious Surveillance

The most interesting (and biggest paying) aspect of private investigating is surveillance. Yes, despite what you may have been led to

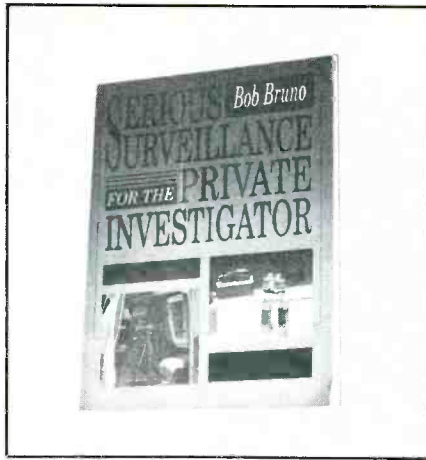

believe, it's a matter of basic observation and how one goes about that task. Remember "Popeye" Doyle standing out there in the bitter cold warming his hands on a cardboard coffee cup while he waited for someone to leave a fancy restaurant? That's surveillance.

It doesn't have to be that tedious any longer, though. These days, it can be done with a bit more comfort. And it can be most challenging. Bob Bruno's 96 page illustrated book, *Serious Surveillance For The Private Investigator* is a nuts and bolts manual about doing all aspects of surveillance. This includes tailing, as well as photographing or videotaping, the target subject.

Each job, and each hour and location where the job is to be done, requires special planning and specific equipment so that the desired results are obtained. You think it's easy standing around for an hour or two in one spot on a city street, especially at night? If you don't get mugged, you stand a good chance of getting arrested on suspicion of one thing or another. Bruno explains how to do the job effectively, so that you survive to deliver your report and collect your fee.

Drawing upon his 25 years of experience in the field, Bob Bruno, shows how to outfit a surveillance vehicle, and how to set up your communications systems. He's got excellent information on setting up a dossier, too.

*Serious Surveillance For The Private Investigator*, by Bob Bruno, is \$20.00, plus \$6 for UPS shipping, from Paladin Press, P.O. Box 1307, Boulder, CO 80306. Colorado residents please add 3.7 percent tax.

## In Addition . . .

IPC/92 is a handbook that describes Interference Phase Cancellation, a practical method for suppressing interference that occurs at the same frequency as the desired signal, or that occurs so close to it that application of conventional filters is impractical. This is a free publication, and is available from Linda DeCoursey, Microwave Filter Company, Inc., 6743 Kinne St., East Syracuse, NY 13057.

*Guide To The AR1000*, by Howard Bornstein, is a 90 page guide to understanding and using the AOR AR1000 wide range handheld scanner. This covers all versions of the

**INTERFERENCE PHASE CANCELLATION**  
DESCRIPTION OF METHOD • EQUIPMENT CATALOG • DETAILED APPLICATIONS  
**Handbook & Catalog IPC/92**

APPLICABLE TO:

CATV And Other Broadband Cable Systems

- Co-Channel Interference
- Intentional RF Interference
- Overload By Adjacent TV Or FM Channels
- Transmitter Harmonics Received In-Band
- Clustering

Interference To VHF Microwave Receivers

- In- To Nonco-Ord Channel Transmitters
- In- To Co-Channel Transmitters

Interference To TVRO Installations By:

- Strong Analog Terrestrial Carriers
- Wideband (Digital) Terrestrial Transmitters

Interference To UHF/Cellular Paging:

- High Power TV Sideband Encroachment

Phase Cancellation (90 Degree Phase Shift) Amplifies Or Reduces Signal

Phase "Technique"

**SUMMARY OF PHASE CANCELLATION PRINCIPLE**

Interference Phase Cancellation (IPC) is the only practical method for suppressing interference which occurs at the same frequency as the desired signal - or which occurs so close to it that application of conventional filters is impractical. In the application of IPC (see diagram above) the receiver sees two samples of the interference: the second one deliberately imparted on the TVST antenna. The Phase allows cancellation of the original interference by placing the second sample in the phase opposition but equal amplitude at the receiver terminals. The desired signal is unaffected. Since the modulation envelopes of the two interference samples are identical, they mutually cancel one another with nothing "left over" to affect the desired signal.

OUR 25<sup>TH</sup> YEAR HELPING YOU SUPPRESS RADIO INTERFERENCE  
Microwave Filter Company, Inc. • 6743 Kinne St. • East Syracuse, NY 13057  
Full Price \$19.95 • Canada \$29.95 • UK £12.95 • France \$29.95 • Japan \$49.95 • West Germany \$29.95

AR1000, including the AR1000X, AR1000XC, AR1000XLT, AR2000, Fairmate HP100, HP200, and HP2000. It also is appropriate for the AR2800 mobile/desktop scanner. This book covers all operations, applications, accessories, and reference information, and is intended to make up for what the author feels is the limited information available regarding utilizing these scanners to their fullest potentials. Beginner's information is provided as well as advanced techniques for the sophisticated scannist. This is an excellent publication and is recommended for all owners of these fine scanners. The book

# Guide to the AR1000

Operations  
Applications  
Accessories  
Reference

By Howard Bornstein

is \$14.95, plus shipping (\$3.50 in the USA, or \$3.75 to Canada—payments in US funds only, please). Order it from Design EQ, P.O. Box 1245-PC, Menlo Park, CA 94025. ■

## MARITIME FREQUENCY DIRECTORY

HF - VHF - UHF - 800 Mhz

Robert Gad  
Robert A. Coburn, Editor

- Coast Guard
- High Seas Radio Telephone
- Public Coast Stations
- Limited Coast Stations
- Operational Fixed Stations
- Automated Maritime Information Systems
- Ship to Ship
- Emergency Distress
- Utility Coast Stations
- VHF Marine Operator
- Search and Rescue
- Port Operations
- Commercial
- Recreational
- National Weather Service
- Mississippi River System



A 400 page Directory covering Low Frequencies, Medium Frequencies, High Frequencies, Very High Frequencies, and UHF Frequencies. General System Information includes Coast-Ship Frequency Cross Reference Charts, High Seas Radio Telephone, Public Correspondence, Coast Guard, and FCC Frequency Allocation Charts.

The Community Listings contain over 27,500 listings and are listed by State, City, Service, License, Call Signs, Channel, Coast Frequency, Ship Frequency, and Comments. New 1991 ITU Frequency Allocation Changes are included for High Frequencies.

**PRICE IS \$ 24.95**

\*Include \$ 3.05 Shipping and Handling\*  
\* ORDERS SHIPPED SAME DAY \*

OFFICIAL scanner guide  
Post Office Box - 712  
Londonderry, New Hampshire 03053

# NEW PRODUCTS

## REVIEW OF NEW AND INTERESTING PRODUCTS

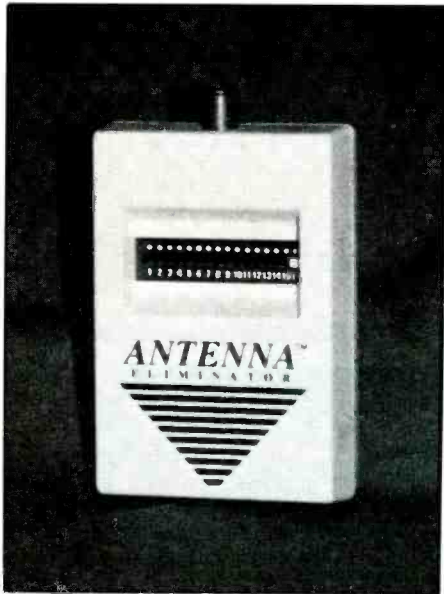

### HF/VHF/UHF Receiving Antenna Eliminator

The Model AE-12 plugs into any ordinary AC wall receptacle to serve as an interface allowing safe access to your building's electrical wiring as a receiving antenna. The AE-12 is UL listed. It is fully tunable to peak your reception from 100 kHz through 900 MHz, so it can be used for local AM, scanner, VCR, FM-stereo, VHF/UHF TV, or other reception.

The AE-12 is supplied with 6 ft. of coaxial cable, F-type connectors, 75-to-300 ohm VHF/UHF splitter, and instructions. If your scanner has a standard BNC antenna connector, a small, inexpensive adapter (such as Radio Shack #278-251) will instantly connect the AE-12. The AE-12 carries a 1-year limited warranty for manufacturing defects or malfunction.

The AE-12 does away with ugly, clumsy, and ineffective directional rabbit ears and loops, telescoping whips, and other built-in radio, TV, and scanner antennas, etc. Puts an end to landlord "outside antenna" prohibitions. Ends wind, ice, and other weather damage to your receiving antenna. Turns the building's wiring into a huge omni-directional receiving antenna. The AE-12 is not intended for transmitting, or for use inside of metal buildings, or when AC lines are surrounded in conduit.

The Model AE-12 is \$37.50, plus \$3.50 UPS shipping (sent by 1st Class mail to AK, HI, PR, VI, GU, military addresses, and Canada). It's from CRB Research, Box 56, Commack, NY 11725. Residents of NY State, please add \$3.49 tax.

For more information, contact the company, or circle 101 on our Reader's Service.

### New 800 MHz Antennas

MAX System Antennas announces two new 800 MHz antennas for the serious listener. High gain beam performance is now within the reach of any listener. The powerful 11 element, rear-mount loop yagi beam antenna allows clear reception of distant 800 MHz signals. The tiny Stinger is a "tuned marconi" design that replaces the stock hand-held scanner antenna and offers superior reception in a compact package at an affordable price.

These two antennas are complete... no soldering or assembly is required... just attach a cable terminated in a Type-N connector to the Loop-Yagi, or use the Stinger's built in BNC connector for your handheld scanner. Both antennas cover the entire 800 to 900 MHz range.

Free Cellular frequency charts are included with both antennas, and as with all Cellular Security Group products they carry a full satisfaction guarantee.

The antennas may be ordered from Cellular Security Group, 4 Gerring Road, Gloucester, MA 01930 (1-800-487-7539). Prices: Loop Yagi (\$75.00) Stinger (\$7.95) Add \$4.00 for shipping.

For more information, contact the company or circle 102 on our Reader's Service.

### Join Packet Action

MFJ Enterprises, Inc. announces the new MFJ-1271 TNC, \$49.95.

If you have a Commodore 64/128 computer and VHF handheld or HF SSB transceiver, the inexpensive MFJ-1271 is the only additional item you will need for joining packet fun. It simply plugs into the Commodore's rear cassette port. It works both VHF packet at 1200 baud and HF packet at 300 baud. This is a high performance modem/TNC with DCD circuit and adjustable threshold control to reduce noise susceptibility and increase your QSO/connect success... especially on HF bands. A DCD LED is included to indicate when you are receiving signals properly. You can't miss... even if you are a packet newcomer!

The MFJ-1271 also sports remote packet operation, mailbox-like message forwarding and Net/ROM emulation, plus much more. It uses MFJ's famous Digicom/64 public software available as MFJ-1293 for \$5.00. This software is also available from many shareware/public domain software companies.

Here is your solution for getting started in packet action on a low budget!

It comes with MFJ's one full year unconditional guarantee.

For more information or to order, contact any MFJ dealer on MFJ Enterprises, Inc., P.O. Box 494, Mississippi State, MS 39762, or circle 103 on our Readers' Service.

## IMPROVE RECEPTION



### SUPER SCANNER STICK

Only \$80

Get great scanner reception with our SUPER SCANNER STICK. Covers all scanner bands (25-1200MHz) Only 35" long. Powerful 15db amplifier. 25' of cable supplied with connector for your scanner.

SCANNER STICK Same as above but without booster amplifier \$40

CELLULAR reception unsurpassed! Our new SUPER DANA antenna combines a 9db gain antenna with 15db amplifier for fantastic 800-950MHz reception. SUPER DANA \$80

### ANTENNA PLUS

\$90



Make your receiver spring to life! Receives like the large antennas yet sits on your table! Strong internal 15-22db amplifier! 115VAC pwr. Cable to rcvr. INCLUDED!

ANTENNA PLUS-1 0.5-1200MHz "All Bands" (for wide coverage rcvrs)  
ANTENNA PLUS-2 0.3-30MHz "Short-Wave" (packed for SWL)  
ANTENNA PLUS-3 25-2000MHz "Scanner" (packed for VHF-UHF)

### AM BROADCAST LOOP ANTENNA

Fantastic AM (5-2MHz) reception without bothersome noise! Easily null out interference! Compact desktop unit with internal amplifier. BCL-1 \$125

### SHORTWAVE ANTENNAS

Super reception with the MULTIWIRE. At 0.3-30MHz and 130' long for FULL SIZED performance! MW-4 \$100

Fine reception 2-30MHz with our BW 60 SWL antenna. Only 60' long and only \$40! SALE \$35 till 9/1/92!

### MOBILE SCANNER & WORLDWAVE ANTENNAS!

Suction cup mounted for easy installation! SUPER models have internal preamplifier for strongest signals. Models for "ALL BANDS" (0.53-1200MHz), "SWL" (.53-30MHz) and "SCANNER-FM-TV" (25-1200MHz). Order SIGNAL SCOOP \$45 or SUPER SIGNAL SCOOP (with amp) \$80

### LISTEN TO HOURS OF SCANNING IN MINUTES!

Our TAPE SAVER interface makes your recorder operate only when there's action on your scanner. Tape Saver TS-1 \$60

Continuous US Shipping/Handling \$5. Canada, AK, HI, PR \$8. NY and NJ add sales tax.

MANY NEW PRODUCTS CALL FOR DETAILS!

ELECTRON PROCESSING, INC.  
PO BOX 68 CEDAR, MI 49621 (616) 228-7020

## Let Your Computer Control Your Radio! with SCANCAT

Once you use the SCANCAT computer program with your radio, you will never operate your radio again without it! SCANCAT Version 4.5 controls the following radios:

- \* AOR 2500, 3000
- \* JRC NRD-525, NRD-535
- \* DRAKE R-8
- \* KENWOOD R-5000, TS-440,
- \* ICOM R-71, TS-450, TS-711, TS-950
- \* R-7000, R-9000
- \* YAESU FRG-757GX, FRG-9600

### UNIVERSAL FEATURES

- \* Create Frequency Databases
- \* Scan between ANY frequencies
- \* Up to 400 frequencies/file
- \* Scan by ANY increment & delay
- \* Built-in TNC comm program
- \* Share ANY radio's file



### AOR-3000, ICOM, NRD-535, FRG-9600 FEATURES

- \* Auto signal detection/scan stop
- \* Auto logging to diskfiles
- \* Spectrum analysis with spectacular graphics
- \* Save/load radio's memories to disk

Version 4.5 also includes SCANPORT. SCANPORT allows you to download your favorite BBS or import most columnar frequency lists to a running SCANCAT file.

CALL or write for FREE information or for our \$5.00 fully operational demo disk. We are so convinced you will buy SCANCAT, we'll even refund the cost of the demo and postage when you purchase SCANCAT!

Requires MS-DOS compatible computer w/RS-232C serial port. Manufacturer's interface not included.

Optional squelch detect cable - \$24.95

+ \$5.00 P & H  
**\$49.95** (Foreign add'l \$2.00)

Charge Cards and COD Welcome - Please Call!

J&J ENTERPRISES 4001 Parkway Drive  
Bossier City, LA 71112  
Phone (318) 631-3081 (10-5)  
FAX (318) 631-3082

# Two For The Road

## We Look At Two New Products For Communications Hobbyists – The Realistic PRO-2026 Mobile Scanner, & The Innova DC Power Pack!

Here are two new items geared to catch your imagination, Radio Shack's Realistic PRO-2026 mobile scanner, and Innova's interesting DC power pack.

The Realistic PRO-2026 is an all-band 100-channel job, that includes the 800 MHz band (except for the cellular bands—we don't know if they can be unlocked). In addition to the 100 selectable channels, which are set up in five banks of 20 each, there is a Service Search feature.

Service Search is a handy thing. In case you've never used it, there are front panel buttons marked for the police, fire, air, weather, and marine bands. When you press any of those buttons, you zip directly to a large group of pre-programmed popular frequencies in the selected service, and the unit goes into search mode and begins trying to locate activity. This is a great aid for locating new frequencies to enter into the unit's regular memory slots. Of course, you still also have the regular search/scan feature available, where you can set your own lower/upper frequency search limits.

The overall frequency coverage of the PRO-2026 is 29 to 54 MHz (in 5 kHz steps); 108 to 137 MHz (12.5 kHz steps); 137 to 174 MHz (5 kHz steps); 406 to 512 MHz (12.5 kHz steps); and most of 806 to 956 MHz (12.5 kHz steps). Channels can be locked out, as well as given two-second delays. There is also a priority channel feature. The unit scans at 14 c.p.s., but searches at 19 c.p.s.

The sensitivity of the Realistic PRO-2026 at 20 dB S/N with 60 percent modulation for AM, 3 kHz deviation for FM, is 0.5 uV from 29 to 54 MHz; 0.7 uV 108 to 512 MHz; 0.8 uV above 806 MHz. Selectivity is plus/minus 9 kHz at -6 dB, plus/minus 15 kHz at -50 dB. The IF frequencies are 450 kHz and 10.8 MHz.

The PRO-2026 is small in size. Just a shade over 6 by 7, and less than 2 inches high. It requires 12 VDC. It comes with a mobile mounting bracket. The entire package for \$199.95.

Radio Shack provided us with a PRO-2026 to try, and we found that it gave a generally good account of itself. The set is all black (cabinet and faceplate), with black buttons having white lettering. It's good-looking.

The squelch control is a lever that is con-



Could the PRO-2026 be in your future?

centric with the volume control knob (which is also the on/off switch). We were pleased to find that our chunky fingers did not have problems when opening the squelch all the way (rotating it clockwise). Our initial fear was that we might bump our fingers into the adjacent "scan" button. That's because the PRO-2026 is about the same size and has a rather similar panel layout to the Bearcat BC-760XLT and BC-590XLT. Those sets have a prominent "scan" button that manage to get themselves pressed and activated practically every time we adjust their squelch controls. The scan button on the PRO-2026, though, is smaller and was not easily knocked into by accident.

We liked the performance of the PRO-2026. It's easy to use, and very simple to program and operate. You don't even really need to look at the instruction book, although the book is very thorough. The book lists the set as having six birdies, all below 52 MHz.

This is a hot little mobile scanner. It's compact and it does a good job. Maybe best of all, it's reasonably priced.

The other new product that came our way is Innova's DC Power Pack, a 12 VDC, cordless, rechargeable power source designed for a wide variety of electronics applications. With an MSRP of under \$65, it is now available at electronics retailers.



Innova's new 12-volt power pack is well-suited to the communications hobbyist.

Innova's unit is ideal for powering cell phones, CB's, scanners, ham handhells, TV's, camcorders, tape recorders, small power tools, fluorescent lights, etc. It has many applications for hobby, mobile, camping, field, home, maritime, and also emergency stand-by uses.

This unit has a maintenance-free, sealed lead-acid rechargeable battery. It puts out 12 VDC, 6.5 Amp/hour. The outputs are via a fused negative-ground socket, and a fused

modular contact. The entire unit weighs less than 7 lbs.

Recharging may be done in three different ways. It can be charged in between one and three hours via a cigarette lighter plug (with the vehicle engine running). Or, an optional AC adapter permits recharge from house current in eight to ten hours. An optional solar panel offers a recharge in eight to ten hours. A protection circuit prevents the battery from being over charged. The battery is good for from 400 to 1,000 recharges.

On a full charge, it will typically run a 2W device for as long as 36 hours, a 12W device for 6 hours, an 18W device for 3 hours, and a 45W device for an hour.

The unit has a carrying handle, and also a strap so that it may be slung on the shoulder. Accessories include a 10W lantern, a 7W flashlight, and a 2W cellphone cradle.

We found any number of handy uses for the evaluation sample Innova provided us. It was well made and functionally designed. It certainly provided sufficient reserve power to offer peace of mind, lights, and/or comms during trips into the field, or during a temporary power failure at home.

Here's a product that we recommend as providing a useful service at a good price. It's from Innova Electronics Corporation, 17291 Mt. Hermann St., Fountain Valley, CA 92708.

Reviewed by POP'COMM Staff.

## The Best\* Just Got Better!

The Eavesdroppers™ now includes our new Zap Trapper™ Electronic Gas Tube Lightning Arrestors. Receive-only design shunts damaging transients to ground at only 1/7th the voltage buildup of the available 200 watt transmit-type arrestors, providing maximum solid state receiver protection.

Protect your investment - combine an excellent shortwave receiving antenna with the best receiver protection money can buy.



- Completely assembled and ready to use
- Only 42" overall length
- 8 trap circuits permit reception on all shortwave bands, 1-90 meters
- All connections soldered and enclosed in ultrasonically-welded, hermetically-sealed trap covers
- Includes 50' of 450 lb. test nylon rope

**Model T** includes 100' twinlead feedline

**Model C** includes weatherproofed center connector for your coax & coax sealant

- Either model \$79.95
- UPS for lower 48 states \$4.00
- COD add \$3.00, IL add 7% sales tax
- Foreign shipping quoted

"The best...built like an antenna should be." -Larry Magne in *World Radio TV Handbook*

"Our best seller." -EEE in their recent ads and catalogs

"Now in use in 45 countries." -Gilfer Shortwave in 1983

### Antenna Supermarket

PO Box 563 Palatine, IL 60078 Tel (708) 359-7092 Fax (708) 359-8161

At your dealer or direct • Visa & Mastercard accepted



## Holiday Book Ideas from HR Bookstore

### Passport to Worldband Radio

1993 Edition Same price with 32 more pages. Brand new and crammed full of all the latest information from shortwave broadcasters from around the world. Includes schedules, frequencies and programming information. Must buy for the SWL. Great gift idea too! ©1992 1993 edition

IBS-RDI93 Softbound \$16.95

### Confidential Frequency List by Gilfer

Classic reference guide for the SWL. Listings cover just about every utility station on the air. Includes hundreds of new RTTY listings as well as ship-to-shore, INTERPOL, embassies, aeronautical, spy "numbers" stations plus much more. ©1992 8th edition

GL-CF2 Softbound \$19.95

### Military Terms and Almanac of Nations

The military has an acronym for everything. Wonder what they mean? This book has the answers! Full explanations for all armed forces plus hundreds of pages of additional helpful information. Great to have as you scan the shortwave bands. © 1992

DT-MT Softbound \$12.95

### Equipment Buyer's Guide from CQ 1993 Edition

Covers equipment for amateur radio and SWLs. Includes all the latest equipment, accessories and other items for the shack. Great Holiday gift buying guide. Manufacturers and dealers listed with addresses and phone numbers for easy reference. Stocking stuffer! © 1992

CQ-EQP93 Softbound \$4.95

### SHORTWAVE Communications by Peter Rouse GUIDKD

This is a great all-round book for the beginner. Describes in simple terms all the elements of how to put together a SWL station. Tells you how to use your radio, what antennas are best, frequencies to monitor plus much, much more. Also included are CB terms and Amateur Radio "Q" signals. A brief review of past and present receivers and accessories make this a book to have.

© 1991 190 pages

PW-SWC Softbound \$9.95

### Shortwave Listening Guidebook

by Harry Helms

One of our most popular books. Complete guide to shortwave radio. Gives you a overview of antennas, radios, equipment and accessories for your station. Also covers propagation, international broadcasters, utility stations plus clandestine "mystery" stations. Easy-to-read style makes this book a special value for both the beginner and expert. © 1991 316 pages First Edition

HT-SLG Softbound \$16.95

### Other SWL Titles

The Underground Frequency Guide \$10.95

Spies, smugglers and guerrilla forces

The World Is Yours \$9.95

What to buy, where and when to listen

Shortwave Receivers Past and Present \$8.95

Over 200 receivers covered

Travelers Guide to World Radio \$9.95

Pocketbook guide full of information

1992 CQ Antenna Buyer's Guide \$4.95

Antennas from all manufactures

**Order Information - US Orders** - Shipping \$4.00 by US Mail, \$5.00 by UPS Ground, UPS Red (overnight) and UPS Blue (two day) are available for shipping cost plus a \$5.00 handling charge. **FOREIGN ORDERS** Canadian orders ship by US Mail for \$5.00. All other foreign orders shipped via US Mail for postage plus a \$5.00 handling charge. \*\*\*Call for Free catalog\*\*\*



HR Bookstore • PO Box 209 • Rindge, NH 03461 • (800) 457-7373 • (603) 899 6826 FAX



# Selected English Language Broadcasts

Fall - 1992

BY GERRY DEXTER

**N**ote: There are hundreds of English language broadcasts aired every day on shortwave. This is a representative listing and not intended to be a complete guide. While every attempt is made at making the list as up-to-date as possible, stations often make changes in their broadcast hours and/or frequencies with little or no advance notice. Some broadcasters air only part of a transmission in English, or may run the English segment into the next hour or more. Some stations have altered schedules on weekends. Numbers in parenthesis indicate in English, or may run the English segment into the next hour or more. Some stations have altered schedules on weekends. Numbers in parenthesis indicate an English start time that many minutes past the hour. All times are in UTC, which is five hours ahead of EST.

Time	Country/Station	Frequencies	Time	Country/Station	Frequencies
0000	Radio Havana Cuba	11970	R. RSA, South Africa		7210, 7230, 7270
	R. For Peace Int'l, Costa Rica	7375, 13630, 15030, 21465		R. Romania	5990, 6155, 9510, 11830, 11940
	HCJB, Ecuador (30)	9745, 15155		VOFC, Taiwan	5950, 9680, 9765, 11740, 11860, 15345
	Christian Science Monitor	7395, 9850, 13760		UAE Radio (15)	11945, 13675, 15400, 15435
	R. Beijing, China	9770, 11715		RAE, Argentina	11710
	R. Korea, S. Korea (30)	15575		R. Cairo, Egypt	9475
	R. Czechoslovakia	7345, 9580, 11990		R. Tirana, Albania (30)	9580, 11820, 11825
	R. Sofia, Bulgaria	11660, 11720, 15330		RCI, Canada	9535, 9755, 11845, 11940, 13720
	R. Norway (Sat/Sun)	11700, 11795, 15165, 17730		R. Sweden	9685, 11705
	R. Yugoslavia (30)	11870		Swiss R. Int'l	6135, 9650, 9885, 12035
	R. Exterior Espana	9530		Vatican Radio (50)	7305, 9605
	R. Netherlands (30)	6020, 6165, 9860, 11665, 11830, 13700			
	R. Nacional Venezuela (40)	9540			
0100	Vatican Radio (45)	9650, 11935	0300	V of Germany	6085, 6145, 9640, 9700, 11810, 11890, 13610, 13770, 15205
	V of Germany	6040, 6085, 6145, 9565, 9700, 11810, 11865, 13610, 13770, 15105		TWR, Bonaire	9535, 11930
	RAI, Italy	9575, 11800		Radio Beijing, China	9690, 9770, 11715
	R. Czechoslovakia	5930, 7345, 9580		R. Czechoslovakia	7345, 9810, 11990
	R. Iraq International	15340		VOFC, Taiwan	9680, 9765, 11745, 15345
	RCI, Canada	9535, 9755, 11845, 11940, 13720		R. Sofia, Bulgaria	9850, 11720, 15160
	R. Yugoslavia (30)	11870		R. Tirana, Albania (30)	9580, 11820, 11825
	R. Japan	11840, 15195, 17810, 17835, 17845		R. Japan	11870, 15325, 17810, 17825, 21610
	R. Moscow	11965, 15480, 17570, 17610, 17655, 17890, 21625		R. Havana Cuba	6180, 11970, 13700
	R. Austria Int'l	9875, 13730		R. Austria Int'l	9870, 13730
	V of Greece (30)	9395, 9420, 11645		R. Netherlands (30)	6165, 9590
				V of Greece (40)	9395, 9420, 11645
	0200	R. Portugal (30)		9570, 9600, 11840	0400
R. Budapest, Hungary		9835, 11910, 15220	RCI, Canada	9650, 11905, 15275, 15445	



# When America thinks Communications,

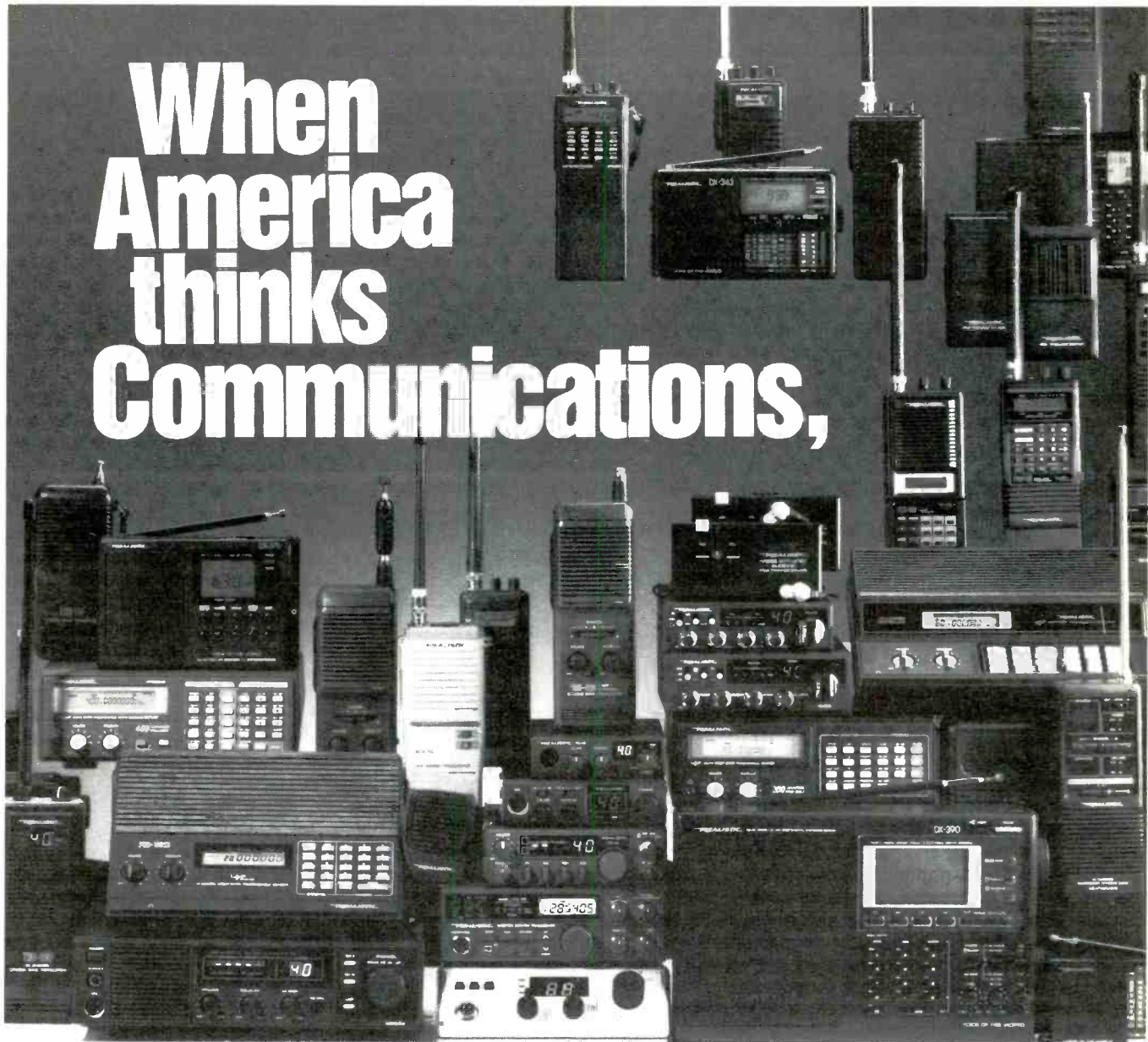

## America comes to Radio Shack



Our name says it all. We have over 50 specialty radios to keep you in touch and informed. Let our knowledgeable, friendly staff help you choose from CB, Ham, business-band and shortwave radios, scanners, Weatheradio® receivers and more. It's no wonder 50 million satisfied customers shop our more than 6600 nationwide stores every year—we've been America's radio headquarters since 1921. *Nobody Compares!*

FREE 1993 Catalog!  
Come in for yours today!

**Radio Shack®**  
**AMERICA'S**  
**TECHNOLOGY**  
**STORE™**

CIRCLE 108 ON READER SERVICE CARD

Time	Country/Station	Frequencies	Time	Country/Station	Frequencies
	Kol Israel	11588		R. Japan	6120, 11815, 11840
	R. Havana Cuba	6180, 11760, 11970		R. Jordan	13655
	R. Beijing, China	11695, 11840			
	SLBC, Sri Lanka (45/Tu)	9720, 15445	1200	R. Beijing	9665, 9715, 11660, 15440, 15450
	R. Norway	9560, 11865		R. Korea, S. Korea (15)	9750
	R. Romania	5990, 6155, 9570, 11830, 11940		R. Ulan Bator, Mongolia (M/Th/St)	11850, 12015
0500	V of Germany	5960, 6130, 9515, 9670, 11705, 11925, 13610, 13790		Tashkent, Uzbekistan	7325, 9715, 15460, 17815
	V of Nigeria	7255		R. Cairo (15)	17595
	RCI, Canada (18)	6050, 6150, 7295, 9750, 11775, 17840		R. France Int'l (30)	21645
	R. Georgia	11705, 12050		R. Finland (30)	15400, 17880
	R. New Zealand Int'l	17770		R. Bras, Brazil	11745
	R. Japan	17765, 17810, 17825, 17860, 21610		RCI, Canada	9635, 11855, 17820
	REE, Spain	9530		R. Bangladesh (30)	15208, 17750
	R. Moscow	15470, 15545, 17570, 17610, 17655, 17890		V of Vietnam (30)	9840, 12020, 15010
	Vatican Radio	6245, 7250, 11625, 15090, 17730		V of Greece (35)	15565, 15650, 17515
	R. Austria Int'l (30)	6015	1300	FEBC, Philippines	11995
0600	AWR, Italy (30)	7205		R. Beijing	9715, 11660, 11855, 15440
	TWR, Monaco (35)	9480		KNLS, Alaska	11580
	R. RSA, Africa	15220		BRT, Belgium	17555, 21810
	R. Korea, S. Korea	7275, 11820, 15170		Kol Israel	11587, 11605, 15640, 15650, 17575, 17590
	Croatian Radio	6210, 9830		R. Pyongyang, N. Korea	9325, 9345, 9640, 13650, 15230
	R. Kiribati	14917.5 USB		R. Jordan (20)	9560
	R. Finland (45)	6120, 9560, 11755		R. Finland (30)	15400, 17880
	V of Mediterranean, Malta	9765		All India Radio (30)	11760, 15120
	TWR, Swaziland	7200	1400	RCI, Canada	11935, 15305, 15315, 15325, 17795, 17820
	R. Austria Int'l (30)	6015		R. Beijing	11815, 11855, 15165
	BRT, Belgium (30)	5910, 11695		R. Korea, S. Korea	9570
0700	AWR, Italy (30)	7230		R. France Int'l	17695, 21770
	HCJB, Ecuador	11730, 15270		R. Finland (05)	6120, 11755, 11820, 15440, 21550
	VOFC, Taiwan	5950		V of Mediterranean, Malta	11925
	R. Norway Int'l (Sat/Sun)	9590, 11740, 17755		R. Japan	9535, 11815, 11865
	V of Hope-Asia, Palau	9830		R. Moscow	15280, 15435, 15480, 15520, 15540, 17615
	Icelandic State Broadcasting (30)	9265		R. Nacional, Venezuela (40)	9540
0800	Christian Science Monitor	11705, 13615	1500	FEBA, Seychelles	11690
	KNLS, Alaska	7365		R. Norway	15355, 17860
	R. New Zealand	9700		Polish Radio	9525, 11840
	R. Australia (30)	6080, 9580, 15240, 17630, 17750, 21745		KTWR, Guam	11650
	V of America	11735, 15160, 15195		BBC	9515, 9740, 15205, 15260, 17840
	R. Netherlands (30)	11895		R. Sweden	15270, 12020, 15010
	V of Greece (40)	15625, 17535		V of Vietnam	9840, 17870, 21500
0900	FEBC, Philippines	9800, 11690		V of Greece (30)	11645, 15630, 17525
	AWR-Italy (30)	7230		Vatican Radio (45)	15090, 17865
	R. Ulan Bator, Mongolia (10)	11850, 12015	1600	AWR, Guam	11980
	Swiss Radio Int'l	13685, 21770		HCJB, Ecuador	15270, 17790, 21455
	KTWR, Guam	11805		R. RSA, S. Africa	9565, 11885
	R. Beijing, China	11755, 15440, 17710		R. Jordan	9650
1000	R. RSA, S. Africa	11900		R. Pakistan	11570, 13655, 15515, 17555, 17725
	R. Korea, S. Korea (30)	5960		BKSKA, Saudia Arabia	9705, 9720
	VOIRI, Iran (30)	9525, 11715, 11790, 11910, 11930		R. Georgia	9825
	R. Norway Int'l (Sat/Sun)	15165, 21595		Polish Radio (15)	7285, 9525, 11840, 6245, 7250, 9645
	R. Australia	6080, 9580, 11880	1700	R. Algiers	9535, 17745
	All India Radio	15050, 17387, 17895		Kol Israel	11587, 11675, 15590, 15640
	Kol Israel	17545		R. Pakistan	9420, 11570
1100	R. Pyongyang, N. Korea	6576, 9977, 11335		V of America	6040, 6110, 7125, 9575, 9645, 9700, 9760, 11910, 15205, 15395, 15495, 15580, 17800, 21625
	TWR, Bonaire	11815, 15345		Swiss R. Int'l	13635, 15430, 17835, 21770
	BRT, Belgium (30)	17555			
	R. Finland (25)	15400			
	R. Yugoslavia (30)	17710, 17740, 21605			
	AWR, Costa Rica	9725, 11870			
	BBC	5965, 6195, 9515, 15220			

Time	Country/Station	Frequencies	Time	Country/Station	Frequencies
	R. Moscow	11820, 11840, 12030, 15450, 15510, 15515, 15520, 17810	2100	R. Ukraine Int'l	5960, 7330, 9600, 9865, 15570, 15585
	R. Sofia, Bulgaria (30)	6035, 9700, 11720, 11735, 15160, 15370		R. Sofia, Bulgaria (45)	9700, 11660, 11720, 15330, 17825
1800	R. Kuwait	13620		R. Vilnius Int'l (30)	9675, 9710
	R. Alma Ata, Kazakhstan (30)	15215, 17605, 17715, 17730, 17765		RCI, Canada	5995, 7325, 13650, 15325, 17875
	VOIRI, Iran (30)	9022, 15260		BBC	5975, 9590, 15070
	Radiobras, Brazil	15265		Kol Israel (30)	11587, 11603, 15100, 15590, 15640, 17575
	R. Yugoslavia (30)	6100, 15140		R. Cairo, Egypt (15)	9915
	All India Radio (45)	7412, 9950, 11620, 11860, 15030		R. Damascus, Syria (10)	12085, 15095
	R. Afghanistan	9635		R. Portugal	15250
1900	RAE, Argentina	15345	2200	V of Turkey	9445
	R. Luxembourg	15350		VOFC, Taiwan	17750, 21720
	RCI, Canada	13670, 15260, 17820		V of UAE	13605, 15305, 17855
	R. Georgia (30)	11900v		R. Sweden (30)	6065
	Vatican Radio (50)	5995, 7250		Vatican Radio (45)	9600, 11830
	R. Galaxy, Russia	9880		V of Greece (40)	11645
	Kol Israel	11587, 11605, 11675, 15640, 17575, 17630		R. Havana Cuba	9670, 11930
				R. Moscow	9890, 11860, 11975, 15480, 15515, 21480, 21690
2000	Christian Science Monitor	15265, 17510, 17555	2300	VOIRI, Iran	9022, 15260, 15315
	R. Kuwait	13620		R. Vilnius, Lithuania	9710, 10344USB, 11780, 13645, 15580
	R. Algiers	11715		SLBC, Sri Lanka (30/Mon)	15425
	V of Turkey	9445		V of Greece (35)	9840, 12020, 11645
	R. Damascus, Syria (05)	12085, 15095		V of Vietnam	9840, 12020, 15010
	Swiss R. Int'l	9885, 12035, 13635, 15505		BRT, Belgium (30)	9930, 13655
	R. Portugal	11740		AWR, Costa Rica	9725, 11870
	R. Havana Cuba	15330, 17705		RCI, Canada	9755, 11730, 11940, 13670, 15325
	All India Radio (45)	7412, 9910, 9950, 11620, 11715, 15265			

## PC HF FACSIMILE 6.0 \$99

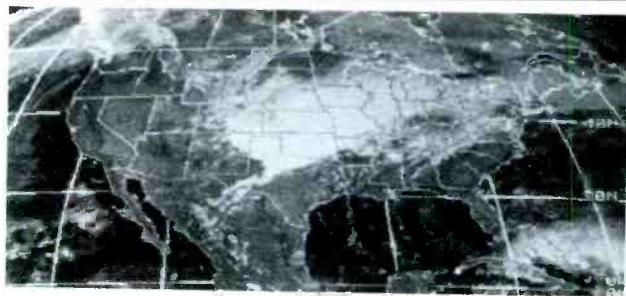

## NOW EVEN BETTER!

Version 6.0 has just been released. It is the most comprehensive fax image reception system for the IBM PC and compatibles. It includes an FSK demodulator, advanced signal processing software, tutorial cassette, and complete 250 page reference manual. The software includes the following advanced features:

Menu Driven  
Start/Stop Tone Recognition  
Unattended Operation  
Tuning Oscilloscope  
Resolution up to 1280x800x256 Levels  
Programmable Colorization  
Brightness and Contrast Control  
Transmit Option Available  
Image Zoom, Scroll, Pan, Rotation

CGA,HGA,EGA,VGA & Super VGA  
Time Lapse Frame Looping  
Slide Shows  
Export to PCX & GIF Files  
Grayscale on all Popular Printers  
Programmable IOC & Line Rates  
Online Broadcast Database  
Image Cropping  
True Color Press Photos

## PC GOES/WEFAX \$250

PC GOES/WEFAX 3.0 is our finest fax imaging system. It is compatible with both HF and direct satellite broadcasts from GOES, METEOSAT NOAA, SOVIET APT and C-Band services. It includes all of the above features plus a complete predictor system and advanced multispectral analysis software.  
Call or write for our catalog of products. Visa & MasterCard welcome.

**Software Systems Consulting**  
615 S. El Camino Real, San Clemente, CA 92672  
Tel.(714) 498-5784 Fax.(714) 498-0568

CIRCLE 98 ON READER SERVICE CARD

## ART-1

**ART-1:** A complete interface system for send and receive on CW, RTTY (Baudot & ASCII) and AMTOR, for use with the Commodore 64/128 computer. Operating program on disk included.

**\$199.00**

**AIR-1:** A complete interface system for send and receive on CW, RTTY (Baudot & ASCII) and AMTOR, for use with Commodore VIC-20. Operating program in ROM.

**\$99.95**



## SWL

**SWL:** A receive only cartridge for CW, RTTY (Baudot & ASCII) for use with Commodore 64/128. Operating program in ROM.

**\$69.95**

**AIRDISK:** An AIR-1 type operating program for use with your interface hardware. Both VIC-20 and C64/128 programs on one disk.

**\$39.95**

**AIR-ROM:** Cartridge version of AIRDISK for C64/128 only.

**\$59.95**



## MORSE COACH

**MORSE COACH:** A complete teaching and testing program for learning the Morse code in a cartridge.

For C64 or C128

**\$49.95**

VEC SPECIAL

**\$39.95**

G AND G ELECTRONICS  
OF MARYLAND

8524 DAKOTA DRIVE, GAITHERSBURG, MD 20877

(301) 258-7373



CIRCLE 97 ON READER SERVICE CARD

# Visit To An Iraqi Comms Van

*Exclusive Photos! Let's Say, It Was Less Than Expected.*

BY AHMED M. ALSAYYED, A71CD

Shortly after the liberation of Kuwait, I had the opportunity to travel from my home (in Alwakra, Qatar) in order to visit that nation. I had gone there for a course being given by the University of Kuwait.

The trip seemed like a good opportunity for me to bring along my camera in order to record any interesting sights left over from the Iraqi invasion and its Desert Storm aftermath.

By the time I arrived, the clean up was well underway. Countless abandoned Iraqi tanks, trucks, armored personnel carriers, artillery pieces, and other pieces of rolling stock were being rounded up and brought to compounds. While some was burned and twisted, other units came through the battle without too much visible damage.

As I strolled through the rows of neatly lined up vehicles, I spotted an Iraqi military communications van, its rooftop antenna system still deployed as if it had been either captured or abandoned while in full operation. The van was open, so I climbed on top and inside to have a look around and take a photo.

No wonder the Iraqi defenses didn't perform too well. The equipment was poorly maintained. For instance, the antenna system was practically rusted out. Hard to see how it could function at all. It couldn't have degenerated to that state in just the brief time since the war had ended, it must have been ignored for many months.

Inside the Iraqi van, the equipment itself looked ancient and tired. Like the antenna system, it also suffered from inadequate maintenance. I was also unimpressed with the quality of the equipment. One thing that did strike me was that the electronic equipment in the van remained relatively undamaged. One CRT display screen had a shattered faceplate, but everything else seemed intact.

The war itself had not damaged the van, neither inside nor out. When they left it, the Iraqi crew that had staffed this van did not even destroy or disable the equipment so it couldn't be used by the enemy. I would have thought this to be basic military procedure.

Maybe the old age and poor quality of the equipment, plus the Iraqi's own negligent maintenance of it, had made such a step unnecessary.

This van was a very revealing exhibit, telling me much more than I had learned in the general media. If it was typical example of the level of Saddam's communications potency during Desert Storm, it explains why the Iraqi radar and jamming efforts were completely ineffectual, and how Iraqi comms were so readily jammed by Allied Forces. ■

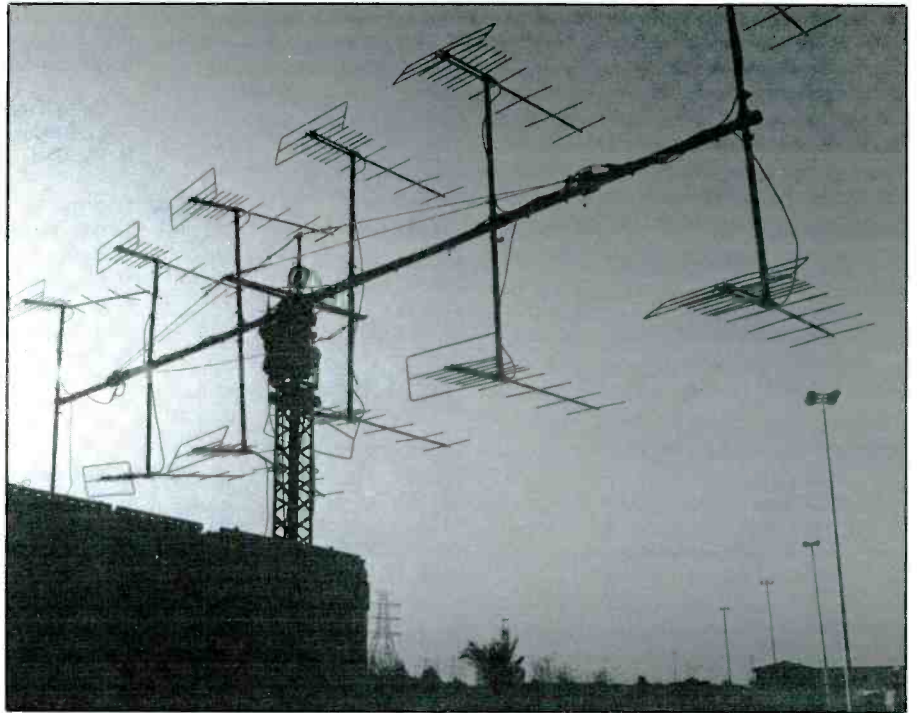

*The Iraqi military communications van had an antenna system that looked good from a distance, but was badly rusted when seen from close range. (Photo by the author.)*

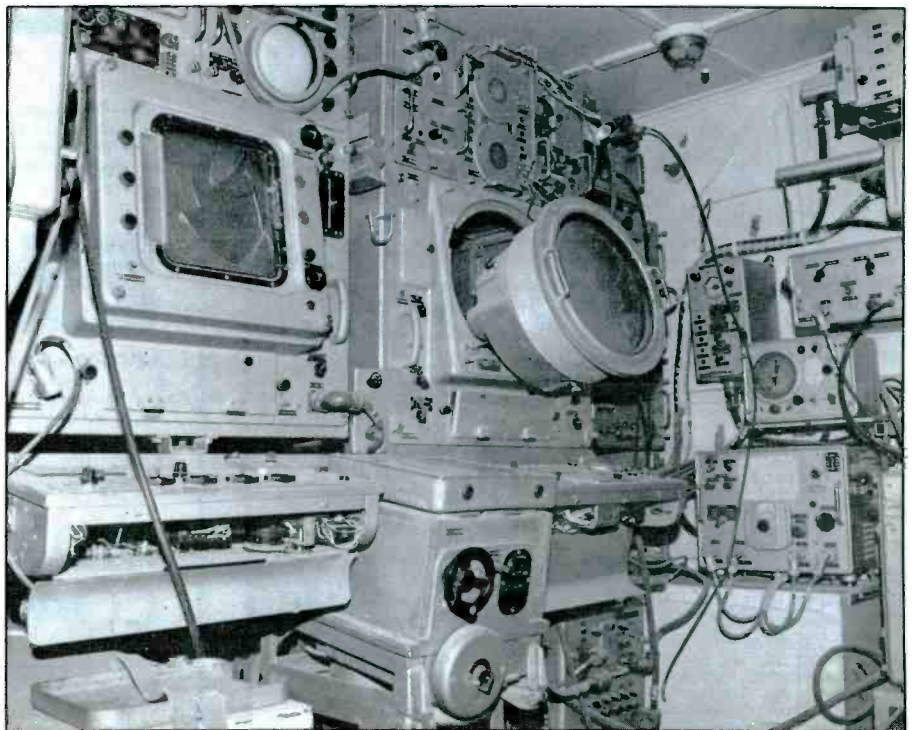

*Inside the Iraqi van, the equipment was tired old junk that had been poorly maintained. The faceplate on the screen at the left was shattered, but everything else was intact. The Iraqis didn't attempt to destroy the equipment before it fell into enemy hand. (Photo by the author.)*

**ACE**  
COMMUNICATIONS  
800 445 7717  
317 842 7115  
ACE Communications Monitor Division  
10707 East 106th Street Fishers, IN 46038

Dial 317 849 8683 to get instant tech information FREE from your Fax!

You can obtain specs and info on these products and more by dialing our Fax Facts automated service. Call our number from your fax, then request the document as listed below. Start your fax and the document will start printing immediately on your fax!



## Shortwave

**SONY ICF2010**  
**\$349.00**  
150KHz to 30MHz  
FM music & Air  
32 memory channels

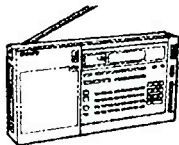

Full HF coverage in the most popular world band radio. Plus FM broadcast and VHF air bands. Synchronous detection and switchable IF bandwidth for great HF listening. Includes earphone and AC adaptor. Requires batteries. Size: 6 1/4 x 11 3/8 x 2 1/16. Wt 3lbs 12 oz. Fax fact document # 510.

**Sangean ATS803 Now \$174.95!**  
Fax fact document #512.

## Scanner & Shortwave

**ICOM R1 Mini Handheld \$439**  
.1 to 1300MHz AM,FM, FM wide. 100 memory channels. AM,NFM,WFM modes. Extremely small. Call for details on other full coverage hand held and base units. Fax fact document #514.

## Software

**Tested and Proven Receive Control Software.** As used in Desert Storm and by many Government Agencies. NOW at special direct promo prices! You can use the full power of your IBM type computer to control any function available through the keyboard of an AR3000 or AR2500 wide band receiver. Plus, you can log the active frequency information and signal strength from the receiver's display. Control up to 4 receivers per computer. Control over long distances. Unique Spectra Graph feature functions like a storage spectrum analyzer. Optional Doppler direction finding and CTCSS & DTMF decode functions. Thousands at \$295. Yours only \$89.95 when purchased with an AR3000 or AR2500. Act now, limited time offer! See inside back cover for AR3000 and AR2500 information.

## Free Stuff

Demo disk of SCS software as above. Call toll free to order, or download it from our BBS at 317 579 2045. Also, Free from your fax machine: Allocation chart of all voice frequencies, plus shortwave, mil air & more freq info Dial FaxFacts#999,989,979



## Mobile Scanners

**Bearcat**  
**760XLTM**  
**\$249.95**  
100 Channel  
800 MHz



Five banks of 20 channels each. Covers 29-54, 118-174, 406-512 and 806-954MHz (with cell lock). Features scan, search, delay, priority, memory backup, lockout, service search, & keylock. Includes AC/DC cords, mtng brkt, antenna. Size: 7 3/8 x 6 15/16 x 1 5/8. Wt: 7.5lbs. Fax fact document #550.

**Bearcat**  
**590XLTX**  
**\$199.95**  
100 Channel  
11 Band



Five banks of 20 channels each. Covers 29-54, 118-174, and 406-512MHz. Features scan, search, delay, priority, memory backup, lockout, service search, & keylock. Includes AC/DC cords, mtng brkt, antenna. Size: 7 3/8 x 6 15/16 x 1 5/8. Wt: 7.5lbs. Fax fact document #570.

**Bearcat**  
**560XLTX**  
**\$99.95**  
16 Channel  
10 Band



Compact, digital programmable unit covers 29-54, 136-174, and 406-512MHz. Features scan, WX search, delay, priority, memory backup, lockout, review,& auto delay. Includes AC/DC cords, mtng brkt, antenna. Size: 7 3/8 x 6 15/16 x 1 5/8. Wt: 2.5lbs. Fax fact document #560.

**Trident**  
**TR-2C**  
**\$89.95**

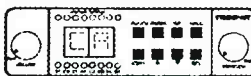

**Scan/CB with optional laser detector**  
Scans pre-programmed by state channels in low, high, UHF & T bands. Weather, 40 ch. CB receive plus mobile relay. Size: 7 3/8 x 6 15/16 x 1 5/8. Wt: 2.5lbs. Fax fact document #580.

**Mag Mount Antenna** Easy to install whip antenna with 20' of coax & heavy duty magnet BNC MA 100 \$19.95  
**Base Antenna.** 25 to 1000MHz coverage with 50' of coax. All mounting hardware included. BNC AS 300 \$59.95  
**External Speaker.** Base or mobile mount. MS190 \$19.50  
**Wide Band Pre-Amp.** Variable gain up to 20dB covers 100 KHz to 1500MHz. 9Vbatt included. BNC. GW-2 \$89.00  
**Interference Filter.** Filters and eliminates common causes of interference to scanners. BNC. Model MPIF-1. \$59.00  
**Downconverter.** Converts 800MHz freqs to 400MHz for 3 band scanners. Quartz locked, 9V batt. DC89. \$89.00  
**Extended Warranties & Service.** Extended warranties available for most models. Call for quote. Out of warranty service by ex- Bearcat/Regency factory techs. Call for quote.

## Hand Held Scanners

**AOR 900 \$199.95**  
100 Channel 800 MHz  
Five scan banks 5 search banks. Covers 29-54, 118-174, 406-512 and 830-950



MHz (no cell lock). Features scan, search, delay, priority, memory backup, lockout, service search, & keylock. Includes AC/DC cords, mtng brkt, antenna. Size: 7 3/8 x 6 15/16 x 1 5/8. Wt: 7.5lbs. Fax fact document #650.

**Bearcat 200XLTN**  
**\$229.95** 200 Channels 800MHz  
Keyboard Programmable.

Ten scan banks plus search. Covers 29-54, 118-174, 406-512 and 806 956MHz (with cell lock). Features scan, search, delay, 10 priorities, mem backup, lockout, WX search, & keylock. Includes NiCad & Chrg. Size: 1 3/8 x 2 11/16 x 7 1/2. Wt. 32 oz. Fax Facts # 450



**Bearcat 100XLTN Now \$159.95**  
100 Channels Keyboard Programmable.

Similar to 200XLTN above without 800MHz. Fax facts #460  
**Bearcat 70XLTP Only \$139.95**  
20 Channels Keyboard Programmable.

10 Band Hand Held with Ni-Cads & Charger. Fax facts #470  
**Bearcat 55XLTR Now \$99.95!**  
10 Channels Keyboard Programmable.

10 Band with LCD. Requires 5AA's. Fax facts #480

## Table Top Scanners

**Bearcat 855XLTE Now \$179.95!**  
50 Channels Keyboard Programmable with 800MHz. LCD display, lock, priority, Search, WX. Fax facts #655

**Bearcat 142XLM Only \$87.95**  
16 Channels with 10 bands. LED display, lockout, priority, WX scan, review key and memory backup. Fax facts #660.

**Bearcat 147XLJ Now \$89.95**  
16 Channels with 10 bands. Track tuned, LED display, priority, WX search, review, memory backup. Fax facts #670.

**Bearcat 172XLM Only \$124.95**  
16 Channels with 10 bands. Track tuned, LED display, priority, WX search, review, memory backup. Fax facts #680.

**Bearcat**  
**800XLX**  
**\$239.95**



12 bands and 40 channels with 800MHz and nothing cut out. AC or DC. Fax facts #690.

## 2 Way Radios

VHF hi band programmable mobiles as low as \$299.95. Call for quotes or Fax Fact #755

Call Toll Free, 24 Hours a Day! Dial 1-800-445-7717. Fax Toll Free, 1-800-448-1084

800 numbers operational in all 50 states, plus Canada. For international voice lines, dial 317-842-7115 or fax 317-849-8794

ACE Communications 10707 East 106th Street, Fishers, IN 46038

Service & Support hours: Mon. - Fri. 9 A.M. to 6 P.M., Sat. 10-4 EST. MasterCard, Visa, Checks, Approved P.O.'s & C.O.D. (add \$5.00) & AMEX (add 5%). Prices, specifications and availability subject to change. Flat rate shipping & handling charge, \$4.95 per unit. Express shipping available, no express C.O.D. One week trial, no returns accepted two weeks after original receipt without substantial restocking charge. All units carry full factory warranty. Indiana residents add sales tax.

VISA

MasterCard

# BROADCAST DX'ING

BY ROGER STERCKX, KVT1JH

## DX, NEWS AND VIEWS OF AM AND FM BROADCASTING

**Belly Of The Beast:** When an earthquake strikes, it means trouble. When it happens in a small community, the local radio station is right in the middle of the excitement. So it was late last June when the double quakes struck in and around Joshua Tree, California.

The first one took out the power at KCDZ/107.7, in Twentynine Palms, also tossing the station's CD's all over the floor. The emergency generator was switched on, then station owner Gary Daigneault summoned the station's staff and also his family to the station to perform emergency duties. His young daughter was there, so were his folks.

KCDZ commenced operations as an emergency center, broadcasting bulletins, taking calls from area residents having special requirements, and acting as a distribution center for vital supplies. The phones rang without stop at the 3 kW station, and Gary Daigneault personally put in a 15-hour shift doing everything from answering phones, being a newsman, and carrying supplies around.

The station performed a vital service to its community, and the dedication of its owner and its staff is worthy of recognition. Many others, of course, also did emergency work. But a broadcasting station has a special ability to reach out to the community that makes small town stations such a vital factor in the structure of our society.

Richard Cockrum, Upland, Calif., was kind enough to fill us in on KCDZ.

**But Where's The Money?:** Contrasting this, it's worth pointing out that these days running a small station mostly means a love of broadcasting coupled with a desire to serve the community. It doesn't necessarily mean showing any financial gain for your efforts.

Stats show that most broadcasters actually lost money during 1991. Major stations raked in the big bucks, but it wasn't so easy for the smaller AM and FM stations. In 1991, 67.5 percent of the AM daytimers lost money, and 55.3 percent of FM-only stations lost money (pre-tax income).

Broadcasters are, quite obviously, a special breed. Their service to the community at large is vital. Somehow there should be tax and other incentives extended to them by municipal, county, and state governments, as well as the feds, to ensure that broadcasters are able to survive financially in order to continue their important services.

**Up For Sale:** For those readers with a sense of dedication who may be wondering about the many ways one might become a broadcaster, it's easier than you might think. A few months ago we received a large postcard inviting us to submit a mail bid before 1 July to buy a combo AM/FM radio station. It was that easy! Just buy the stations in a mail auction.



Ron Chilton, Program Director, of WAVG/WXVW, Jeffersonville, Indiana. (Photo by R. C. Watts, Louisville, Kentucky.)



Main studios of WAVG/WXVW, Jeffersonville, Indiana. (Photo by R. C. Watts, Louisville, Kentucky.)

These stations were WTSL AM/FM, Lebanon, New Hampshire. The AM station is a 1 kW operation (unlimited hours) on 1400 kHz, while the FM runs 6 kW on 92.3 MHz. The sale included all assets, including studios, transmitter, tower, real estate, furniture, fixtures, records, and bank accounts. They wanted a \$25,000 cash deposit in order to submit a bid.

Of course, winning the bid doesn't mean that the FCC will allow the new owner to be one of its broadcast licensees. Buying a radio station without some assurance from the FCC that they'll issue you a license is like buying a bargain-priced car without a pink slip and then trying to register it at the DMV. The postcard neglected to point this out, but it was nevertheless interesting to receive this invitation in the mail from the auctioneer.

*It's Not All Fun & Games, Either:* Just in



Tommy Cull, Marketing Consultant, Station WMPI/100.9, Scottsburg, Indiana. (Photo by R. C. Watts, Louisville, Kentucky.)



The WMPI "Radio 101" here will be a collector's item next year when the station changes frequency and becomes "Radio 105." (Courtesy R. C. Watts, Louisville, Kentucky.)

## Permits, Stations, & Call Letters Cancelled

KAEB	Alamosa, CO	101.1 MHz	9.4 kW
KCLH	Colby, KS	97.9 MHz	100 kW
KCWMM	Barstow, CA	91.3 MHz	3 kW
KDCZ	Delta Jct., AK	93.5 MHz	3 kW
KEEI	Winslow, AZ	95.1 MHz	100 kW
KGZE	Rozel, KS	98.7 MHz	500 watts
KHUA	Seward, AK	88.1 MHz	Low power
KIHG	Mamou, LA	101.1 MHz	3 kW
KLDK	Soldotna, AK	96.5 MHz	100 kW
KLES	Worthington, MN	93.5 MHz	3 kW
KNWY	Powell, WY	104.1 MHz	100 kW
KNYO	Independence, MO	600 kHz	
KOPI	Moab, UT	96.7 MHz	3 kW
KSJJ	Redmond, OR	102.9 MHz	2 kW
KSSB	Calipatria, CA	100.9 MHz	3 kW
KTBA	Tuba City, AZ	97.9 MHz	3 kW
KVPH	Bismarck, ND	92.5 MHz	100 kW
KWFN	Fredonia, KS	104.1 MHz	3 kW
KWHU	Midland, TX	90.1 MHz	3 kW
KWQN	Arcadia, CA	92.5 MHz	3 kW
KXDM	Littlefield, TX	95.5 MHz	3 kW
KYSG	Larned, KS	105.9 MHz	3 kW
KYWG	Sarles, ND	105.9 MHz	100 kW
WAPY	Apalachicola, FL	105.5 MHz	3 kW
WBFX	Grand Marais, MN	100.5 MHz	100 kW
WBKQ	Van Buren, ME	98.1 MHz	3 kW
WDRL	Cuthbert, GA	100.7 MHz	3 kW
WFMM	Harbor Beach, MI	103.7 MHz	50 kW
WHAY	Whitley City, KY	105.8 MHz	3 kW
WKDL	Dwight, IL	98.9 MHz	3 kW
WLFQ	Bruce, MS	94.5 MHz	3 kW
WLIN	Gluckstadt, MS	101.7 MHz	25 kW
WPNI	Kentland, IN	101.7 MHz	3 kW
WPNL	Clinton, IL	93.9 MHz	1 kW
WSAA	Warrenton, GA	93.1 MHz	3 kW
WSAD	Vandalia, MI	89.9 MHz	100 watts
WTHM	Glen Arbor, MI	95.9 MHz	650 watts
WVUV-FM	Pago Pago, AS	101.1 MHz	9.4 kW
WUVX	Knox, IN	89.3 MHz	375 watts
WVKG	Pentwater, MI	103.1 MHz	3 kW
WXJD	Oscoda, MI	95.7 MHz	50 kW
WXJH	Millbridge, ME	93.7 MHz	50 kW

## Applied For Changed AM Facilities

KMIS	Portageville, MO	1050 kHz	Seeks drop to 600 watts.
KUMW	Honolulu, HI	1500 kHz	Seeks 50 kW omni-directional.
KZTU	Junction City, OR	650 kHz	Seeks move to Eugene, OR; 660 kHz.
KZTW	Troutdale, OR	860 kHz	Seeks move to Fairview, OR; 50 kw/450 w.
WDMV	Pocomoke City, MD	540 kHz	Seeks move to Brinklow, MD.

## Changed AM Facilities

KCLS	Flagstaff, AZ	600 kHz	Reduced night power.
WABH	Bath, NY	1380 kHz	Increased to 5 kW/350 w.
WCCC	Hartford, CT	1290 kHz	Moved to W. Hartford; dropped to 490 w.
WOCR	Charlotte, NC	1540 kHz	Dropped to 2.5 kW.

## Applied To Change FM Frequencies

KAWW-FM	Heber Springs, AR	96.7 MHz	Seeks 100.7 MHz, 50 kW.
KLBB	El Dorado, AR	99.3 MHz	Seeks 98.7 MHz, 14 kW.
KMIS-FM	Portageville, MO	106.3 MHz	Seeks 106.5 MHz, 50 kW.
KPYN	Atlanta, TX	99.3 MHz	Seeks 100.1 MHz, 50 kW.
WKLJ	Oxford, KS	107.1 MHz	Seeks 93.7 MHz, 25 kW.

## Changed FM Frequencies

KBLT	El Dorado, AR	95.9 MHz	Moved to 96.1 MHz.
KTJO-FM	Ottawa, KS	88.1 MHz	Moved to 88.9 MHz, 150 watts.
KZMK	Bisbee, AZ	92.1 MHz	Moved to 92.3 MHz.
WCLS	Oscoda, MI	100.1 MHz	Moved to 100.7 MHz, 20.5 kW.
WNCB	Duluth, MN	89.1 MHz	Moved to 89.3 MHz, 2.4 kW.
WSLY	York, AL	99.3 MHz	Moved to 104.9 MHz, 50 kW.

cast you thought that being a broadcaster means you can play all your favorite music and do all of your best bits, that's not always true.

Ken Reuben, of Hamden, Conn., let us know about a dispute concerning a planned format change at WYBC-FM/94.3, New Haven, which is run by Yale University. The station's daytime format consisted of rap and jazz, but WYBC-FM decided to drop that format and switch over to a satellite-fed syndicated programming format called *The Touch*.

That announcement brought a complaint from WNHC/1340, which would put WYBC-FM in direct competition for their listeners. Other loud complaints were heard from community members who were unhappy about the loss of the existing WYBC-FM programming format. This included New Haven's mayor, who expressed "grave concerns" about the proposed WYBC-FM format change.

And you thought being a broadcaster was fun?

*Both Sides Now:* The Senate passed Sen. Larry Pressler's (R-SD) legislation directing the FCC to designate an FM stereo standard.

In 1981, the FCC decided to waffle on picking a standard AM stereo system, stating that the marketplace should decide the issue. Problem is that this hasn't happened, and the FCC has done nothing while AM stereo had just sat there doing virtually nothing for more than ten years. Broadcasters, consumers, and equipment manufacturers are not only confused, they are stuck in a limbo waiting for something to ensue that is obviously not going to take place on its own.

Nobody wants to stick out their neck too far with one system and then find that the public taste is going to head in the direction of another one. An FCC dictated standard, as done with color TV, seems the only way to get the ball rolling.

Last year, Japan's equivalent of the FCC gave up on the marketplace stereo AM selection system in favor of a government mandated standard.

The two most commonly encountered AM stereo systems here are from Kahn and Motorola. From having listened to both systems, we would have to say that they both sound excellent. However, we think Kahn's sounds even better and fuller than Motorola's. Also,

from a technical standpoint, Kahn's is quite simple and a lot less complicated than Motorola's system, to boot. In fact, Mr. Kahn has taken Motorola to court claiming that their AM stereo has infringed upon one of his AM stereo patents.

*Taking Over:* Oklahoma City's KOMA/1520 is now simulcasting on 92.5 MHz as KOMA-FM. The FM slot is the frequency that had been used by KKNG, an easy-listening station that had been on the air for 19 years. KOMA has a six year lease on former KKNG facilities with an option to buy from KKNG's owners in Rhode Island. KOMA already had another local FM outlet, KRXO-FM/107.7, which is programmed separately.

The FCC continues to modify its rules regarding how many stations may be owned by its licensees. Presently, the rules allow a whopping 30 AM stations and 30 FM stations per market. These numbers have not gone over at all well with all members of the broadcasting industry, and with a few members of Congress.

*Open Wide:* Earlier this year, the FCC measured the signal characteristics of 174 AM stations. This was done to see how much AM

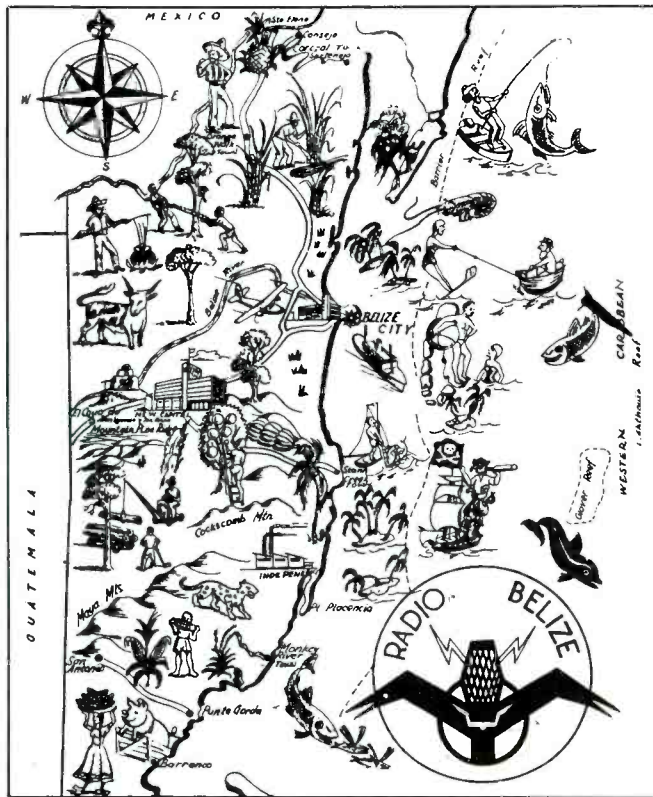

Jason Moore collected this QSL from Radio Belize/830. He picked up the station on his portable while he was on vacation in Florida. (Courtesy Jason Moore, Kentucky.)

### Permits Granted For New FM Stations

AR	Whitehall	104.5 MHz	3 kW
AZ	Tempe	97.9 MHz	100 MHz
CA	Magala	88.3 MHz	1.5 kW
CO	Aspen	107.1 MHz	470 watts
CO	Basalt	106.1 MHz	3 kW
CO	Durango	99.7 MHz	16 kW
CO	Telluride	104.9 MHz	100 kW
GA	Smithville	106.9 MHz	6 kW
IA	Belle Plaine	95.5 MHz	6 kW
IA	Decorah	88.7 MHz	100 watts
KY	Danville	88.1 MHz	170 watts
KY	Hardinsburg	104.3 MHz	3 kW
KY	Philpot	94.7 MHz	3 kW
MI	Alma	90.9 MHz	100 watts
MI	Marlette	92.5 MHz	3 kW
MI	Marquette	91.5 MHz	200 watts
MS	McLain	96.9 MHz	6 kW
NC	Winston Salem	91.5 MHz	10 kW
NJ	Sussex	88.5 MHz	500 watts
NM	Texico	96.5 MHz	4 kW
NY	Conklin	100.5 MHz	3.5 kW
NY	Pt. Jervis	88.9 MHz	500 watts
NY	Watertown	88.9 MHz	200 watts
OH	Ashtabula	98.3 MHz	2 kW
OR	Florence	106.9 MHz	2.3 kW
TN	Benton	93.1 MHz	6 kW
TN	Coalmont	104.7 MHz	1 kW
TN	Cookevill	90.9 MHz	
UT	St. George	95.9 MHz	95 kW
WA	Wilson Creek	103.3 MHz	6 kW
WA	Yakima	90.3 MHz	5 kW

### High Performance 800MHz

FREE CELLULAR FREQUENCY CHARTS!

#### MAX 800 GROUND PLANE

- Absolutely the best reception... 10 times better!!!
- Astounding results outside using our RG6 cable
- Mount directly on base or hand-held scanner

Only \$19.95

Base scanner adapter - \$15.00  
Hand-held scanner adapter - \$12.00  
50 ft RG-6 cable assembly - \$35.00

Max Cellular Mag Mount - mobile 800 scanner antenna - \$29.95  
The Stinger - compact 800 MHz hand scanner antenna - \$7.95  
Loop Yagi - highly directional 15dB gain (3ft boom) - \$75.00

### Cordless and Baby Monitors

FREE CORDLESS FREQUENCY CHARTS!

#### MAX 46-49 MHz DIPOLE

- The very best cordless phone and baby monitor antenna
- Hear conversations for miles around - don't miss anything!
- Install inside or outside
- Includes 50ft RG8X - BNC

Only \$49.95

### MAX System™ Antennas and Accessories

1-800-487-7539 ORDERS ONLY

508-768-7486 FAX  
508-281-8892 INFO  
SASE for free Catalog

146/220/440/GMRS GP	25.95
Telescopic Whip	12.95
Telescopic GP	29.95
146/220 Mag Mount	29.95
146/440 Mag Mount	29.95
BNC Mag Mount	12.95
Custom Ground Plane	39.95
Telescopic Mag Mount	29.95
3 Element 2m Quad	39.95

Send Payment To: Cellular Security Group  
4 Gerring Road  
Gloucester, MA 01930

CK-MO-MC-VISA Accepted (MA add 5%)  
US shipping and handling \$4.00

### Computer Aided Scanning

a new dimension in communications from Datametrics



Now Radio Shack PRO 2006 owners for the first time have access to the exciting world of Computer Aided Scanning with the highly acclaimed Datametrics Communications Manager system. Computer Aided Scanning is as significant as the digital scanner was five years ago and is changing the way people think about radio communications.

The Datametrics Communications Manager provides computer control over the Radio Shack PRO 2006 receiver. Comprehensive manual includes step by step instructions, screen displays, and reference information.

Powerful menu driven software includes full monitoring display, digital spectrum analyzer and system editor. Extends receiver capabilities including autolog recording facilities, 1000 channel capacity per file, and much more.

Uses innovative Machine State Virtualizer technology (patent pending) hardware interface by Datametrics. Simple 4 step installation - no soldering or modification to normal receiver operations.

## Datametrics, Inc

Computer Aided Scanning system \$349. Requires Radio Shack PRO 2006 receiver and IBM PC with 360K memory (640K for full channel capacity) and parallel printer port.

PRO2006 receiver w/interface installed and CAS system \$749

Manual and demo disk \$15

Send check or money order to Datametrics, Inc., 2575 South Bayshore Dr, Suite 8A, Coconut Grove, FL 33133. 30 day return privileges apply.

CIRCLE 139 ON READER SERVICE CARD

THE MONITORING MAGAZINE



spectrum space was being used, and if the stations conformed to the bandwidth limits set in the rules. The FCC survey found that 94 percent of the stations surveyed were conforming to the rules. Still, 11 percent of the stations had signals that exceeded the allowable bandwidth. The FCC may repeat this survey again.

*From Greece:* This column received an extremely pleasant and interesting letter from reader Daniel Danielidis, of Thessaloniki, Greece. Daniel hosts a program about DX'ing over *Radio Outopia/107.7*, and he also writes about radio for the weekly publication *Exostis*.

Daniel is 20 years old, attends a university, and has been a DX'er for two years. If you would like to write to him, his address is: Daniel Danielidis, Alexandrou Svolou 18 St., GR-54622 Thessaloniki, Greece. Daniel is quite fluent in English.

*Better Never Than Late:* You'll notice in this month's FCC station changes that there are many cancellations. For the most part, these appear to be phantom stations. That is to say, stations that were planned for and given the FCC green light for construction quite some time ago. But present business conditions, or perhaps other factors, have caused such extended and continuing delays in getting the stations operational that it no longer appeared realistic to consider that they were making any significant headway to-

wards getting on the air.

The FCC is grudgingly willing to grant a few time extensions in putting a broadcast station on the air so long as there seems reason to believe that a licensee is effectively working to overcome obstacles in order to get on the air. But if too much time elapses and progress grinds to a stop, the FCC tends to pull the plug on the entire project. The feeling is that if it isn't going to happen, there's no point in carrying the proposed station in their records.

As fed agencies go, the FCC has a short fuse and zero tolerance when it comes to the public not meeting its established schedules for things to take place. A good example was a joint application for a review filed by two California holders of FM station construction permits. The application was filed one day late. The applicants explained that they had been unable to file on time because their lawyer's word processing system crashed at the last minute, delaying the completion of their

<b>Requested Call Letter Change</b>			<b>New AM Call Letters Issued</b>		
<b>Now</b>	<b>Seeks</b>				
KVSR	WLMP	Rapid City, SD	KNKQ	Virginia City, NV	
<b>Changed AM Call Letters</b>			<b>Changed FM Call Letters</b>		
<b>New</b>	<b>Was</b>		<b>New</b>	<b>Was</b>	
KUFA	KZZK	Tremonton, UT	KBXD	KBZQ	Lawton, OK
KWFM	KCEE	Tucson, AZ	KHYZ	KXVR	Mountain Pass, CA
WKYD	WWSF	Andalusia, AL	KKJG	KKUS	San Luis Obispo, CA
WNNY	WNLF	Charlotte, MI	KMVE	KMGZ	Lawton, CA
WQBS	WVOZ	San Juan, PR	KRLK	KZRK	Cassville, MO
WSPZ	WZBQ	Tuscaloosa, AL	KWFM-FM	KEFM	Tucson, AZ
WTLM	WXTH	Alexander City, AL	WELY-FM	KQEK	Ely, MN
<b>New FM Call Letters Issued</b>			WENZ	WPHR	Cleveland, OH
KYAJ	Merced, CA		WJXN-FM	WOAD-FM	Utica, MS
KYAT	Keokuk, IA		WKQB	WOHT	Jackson, MS
WKUA	Westwood, KY		WPRG	WPVM	Howland, ME
WLUB	Roanoke, VA		WQLJ	WKLJ	Oxford, MS
WLUD	Deltaville, VA		WRHY	WKYD	Centre, AL
WLUE	Pearl, MS		WRRX	WLCL	Micanopy, FL
WVAV	Hatteras, NC		WSRX	WBPT	Naples, FL
			WWEG	WOTS	Mitchell, IN

## Improve Your Scanning Coverage!

GRE America is proud to introduce a new family of products to enhance your scanning pleasure! First, GRE has designed the new **Super Converter 9001** for base model scanners. The 9001 converts 810 MHz - 950 MHz down to 410 MHz - 550 MHz. The 9001 is the perfect alternative to buying a new, expensive scanner covering the 800 MHz band. Next, GRE announces the new **Super Amplifier 3001** for base model scanners. The 3001 will increase gain by as much as 20 dB, and is engineered to help scanners with low sensitivity pull in weak signals. Both products use BNC connectors, (1) 9 volt battery and have an off/pass switch for returning to normal operation.



Super Converter 9001 & Super Amplifier 3001



Super Converter II



Super Amplifier



All-Band Antenna

*U.S. & International Distributorship inquiries welcome. Please call GRE for further information!*

### Let GRE Manufacture Your Radio Products!

GRE America, Inc. is a leading OEM developer and manufacturer of radio telecommunications products such as:

- Cordless Telephones
- CB & Marine Radios
- Spread Spectrum "engines"
- Remote Monitoring Systems

If you need a high quality, cost competitive, reliable manufacturer, GRE will provide you with a free production quotation.

*For more information, please call GRE at (800) 233-5973. GRE is a subsidiary of General Research of Electronics, Inc.*

**GRE** GRE America, Inc.

GRE America, Inc.  
425 Harbor Blvd., Belmont, California 94002  
(415) 591-1400 Outside California: (800) 233-5973

## Applications Filed For New FM Stations

AZ	Lake Havasu City	92.7 MHz		MN	Staples	94.7 MHz	6 kW
CA	Felton	93.7 MHz	656 watts	NC	Ocracoke	92.9 MHz	1 kW
CA	Lancaster	88.9 MHz	5.5 kW	NH	Keene	90.7 MHz	1.5 kW
CA	Patterson	97. MHz		ND	Wishek	100.3 MHz	100 kW
FL	Dade City	96.1 MHz		NM	Eunice	100.9 MHz	3 kW
FL	Vero Beach	90.5 MHz	3 kW	NM	Grants	103.7 MHz	100 kW
IN	Winamac	100.1 MHz	6 kW	NY	Whiteboro	97.9 MHz	
KS	Andover	93.9 MHz	25 kW	SD	Custer	105.3 MHz	
KS	Downs	94.1 MHz	28 kW	VA	Crozet	103.5 MHz	270 watts
MN	Bemidji	91.3 MHz	60 kW	WA	Castle Rock	107.1 MHz	
MN	Blooming Prairie	100.9 MHz	6 kW	WA	Ilwaco	103.9 MHz	25 kW
MN	Detroit Lakes	102.3 MHz		WI	Biramwood	92.9 MHz	6 kW

paperwork. But they rushed it over to the FCC by messenger, anyway. The messenger arrived at the FCC office at 5:30 p.m. on the last day it could be accepted, but he wasn't allowed to enter the building at that hour in order to file the paperwork with the FCC.

The paperwork was then presented to the FCC first thing the next morning, but the FCC dismissed the application out of hand because of its lateness. The agency said that it was dismissed because the applicants should have reasonably left themselves enough time to deal with unforeseen glitches and delays, also they did not substantiate their claim of having attempted a delivery the previous day at 5:30 p.m.

Anyway, the FCC claimed, one of the applicants' interest in pursuing the rejected application was moot because of another FCC decision.

It was a good lesson in getting to the door on time.

**Bureaucrats Forever Dept.:** An application for a new FM station in Mecca, Calif., submitted by Coachella Valley Wireless Corporation was dismissed by the FCC because the geographic coordinates for the proposed transmitter site didn't exactly match up with those plotted on the topographic site map submitted. When the FCC dismissed this ap-

plication, Coachella Valley, the applicant, asked the FCC to reconsider. Coachella Valley readily agreed that the coordinates were incorrectly plotted on the site map, but pointed out that the correct coordinates were shown in other parts of the application and in the FAA filing. Coachella Valley pointed out that the FCC could have easily resolved the discrepancy by a collect phone call to the their offices, or by asking for a clarifying amendment.

The FCC wasn't interested, stating that the rules state that discrepancies in coordinates result in applications being dismissed. No room for movement there. No reconsideration, either.

In another bureaucratic disaster, JEM Broadcasting Co., Inc., applied for an FM station to be located in Bella Vista, Arkansas. They tripped over the exact same problem, and their application was also dismissed. They asked for reconsideration, stating essentially the same things as Coachella Valley.

The FCC said "the correct coordinates could not have been ascertained from other information in the application since it was not clear which set of conflicting information was correct." On the other hand, the FCC told JEM that their dismissal of the application "did not constitute arbitrary and capricious dispar-

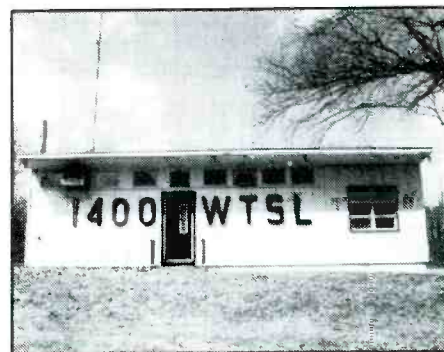

The transmitter building at WTSL/1400 was up for bid last summer!

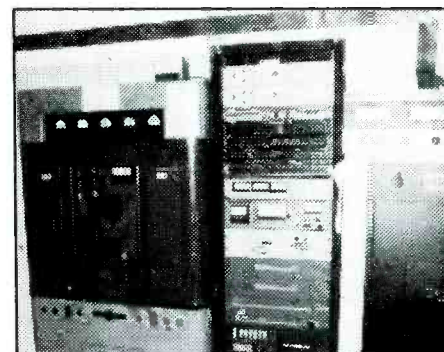

The WTSL/1400 transmitter was part of the items at auction.

## The Choice Is Yours! Priced From \$139!



### CODE SCANNER OR CODE STAR

Both Stand-Alone Units Feature

- ★ Two Morse, RTTY & ASCII Modes
- ★ Automatic Speed Tracking 3-70 WPM
- ★ Easy Hookup To Speaker, Phone Jack
- ★ Code Practice Oscillator & Speaker
- ★ Digital & Analog Filtering With AGC
- ★ 12 VDC Or 120 VAC With Adapter

Made In USA



**CODE SCANNER** - Two line 32 character LCD display. Special Morse practice mode. Lightweight, compact size: 3.5" x 5.75". Hang it up, stick it up, put it anywhere. It's ready to go! Wired \$189 S&H \$6

**CODE STAR** - 8 Large easy-to-read LEDs. Connect to IBM PC or VIC20 computer with optional ASCII Output Port. You build it or we build it! Kit \$139 Wired \$179 S&H \$6 Kit Port \$49.95 Wired Port \$69.95

Free Brochure. Call-Write-Order. MC/VISA. Phone (414) 241-8144

**Microcraft Corporation** Box 513PC Thiensville, WI 53092

CIRCLE 132 ON READER SERVICE CARD

ate treatment since it has treated all similar cases in the same manner."

That's comfort, of a sort, we suppose. Albeit, cold comfort.

**At The Studio Doors:** Someone is pounding loudly on the studio door and ringing the night bell like crazy. It's 2 a.m. If it's not the morning deejay showing up four hours early because his XYL's out there throwing things at him, then it's the FCC to tell me that my AM bandwidth is too wide. One way or the other, the party's over here for now. So join us in December.

Mean time, keep those station photos, AM and FM station bumper stickers, broadcast-related news clippings, and comments heading our way. We look forward to them. ■

# PIRATES DEN

BY EDWARD TEACH

## FOCUS ON FREE RADIO BROADCASTING

Many of the you have heard and verified pirate Radio USA over the past couple of years. The FCC has issued a \$17,500 fine to Andrew R. Yoder of Chambersburg, PA, claiming Yoder, as announcer "Mr. Blue Sky," operated the station from Michigan, Ohio, New York, Pennsylvania, Tennessee, Virginia and West Virginia at various times. In October, 1991 the FCC traced the signal to a Virginia campground where Yoder was a guest, and in February of this year to the home of his parents in Springs, Pennsylvania.

The FCC says Radio USA was one of the most active illegal stations on the air during 1990 and '91. Yoder is the author of a book on pirate radio, and publishes a newsletter on the subject. Is he also the man who has the key to P.O. Box 109, Blue Ridge Summit, PA, 17214—one of the most widely used of the pirate maildrops? Let's hope that doesn't change.

On to this month's reports. WEED Radio was heard by Skip Harwood in California on 7415USB at 0430 claiming to be broadcasting "from the great southwest," playing rock and promoting pot. Michael Schumacher in New Jersey had them at 0615. Ed Rausch in NJ had them to 0545 sign off.

Rausch had the Desert Network with "Saudi Sam" on 7415 at 0113 giving QSL address as P.O. Box 69, Wolf Run, OH 43970. Murphy had this to 0206 close with rock oldies.

Jolly Roger International was heard by Rausch on 7415 at 0430 featuring "Blackbeard" and rock music. Harwood found this at 0457 with comments that reports would go to the ANARC BBS.

Rausch has WHIZ with heavy metal on 7416USB to 0055 sign off with "End of the Road, Bro."

WARI was another Rausch logging, on 7435 at 2345 and again at 0115 on 7415. Ed notes the call stands for "Alternative Radio International." Murphy had this to 0231 sign off, on 7410 with an ID repeated several times: "Alternative Radio. Whisky Alpha Romeo India." Reports go to P.O. Box 452, Wellsville, NY 14895. Pat also heard the station from 2145-2159 with the slogan "the best music on shortwave." "Schumacher had the station at 2250 to 2300 sign off.

Another Murphy logging was WSRN, 7415USB with a "Pink-o the Clown" comedy routine and folk music. Also noted by Rausch at 0305 with "Link-o the Clown" and a QSL address of P.O. Box 293, Merlin Ontario, N0P 1W0, Canada.

Murphy logged Radio Idiot on 7416 at 0048 to 0059 close with rockabilly and

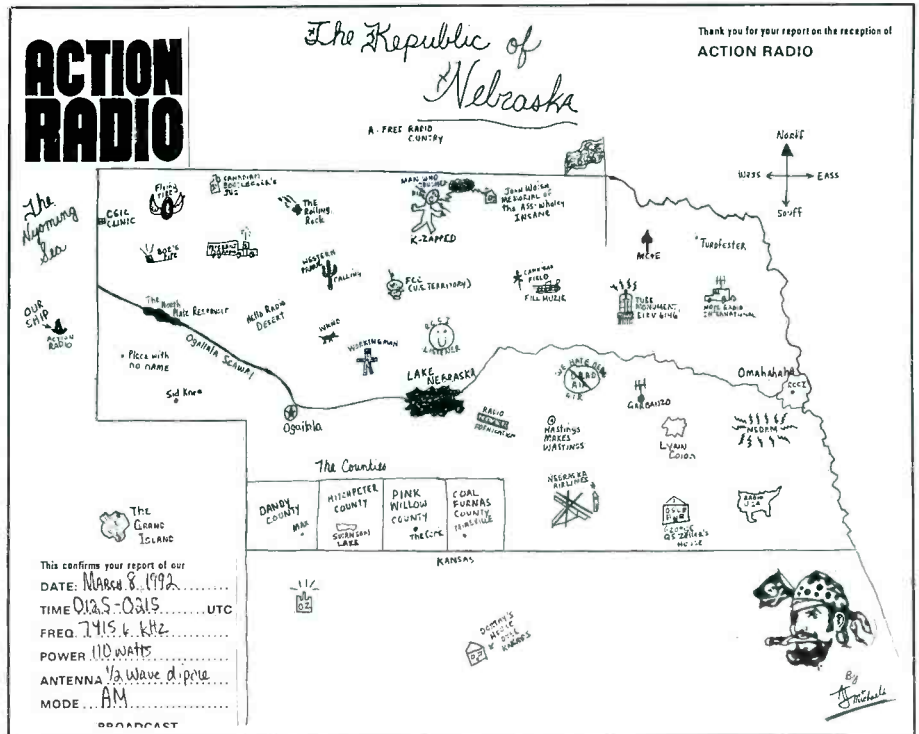

Action Radio's QSL isn't your basic AAA map of the Cornhusker state!

honky-tonk music and IDs "This is W-H-I crazy" and "Radio Idiot." No QSL info announced.

Rausch had WKND, Weekend Radio, on 7415 at 0105, ID as "WKND, Weekend Radio" and having transmitter problems.

Skip Harwood logged Radio Anarchy on 7419 at 0415 with punk rock and flute music, announcing the Blue Ridge Summit mail drop.

Harwood heard KUNT Radio 7418.7 at 0524 claiming to have been in operation since June, 1970 and run by the "Blind mindless skull." Skip notes that this is one of two west coast stations using this ID, the other one being run by a "Captain Beaver." Skip says that both times he's heard The Skull version it followed a broadcast by Radio Anarchy. No mail drop announced.

Michael Schumacher had a station ID'ing as the "new sound of Radio Mirage" on 7415 from 2132 which apparently became WNAR as time progressed. Michael monitored the frequency on through to 0159. The transmission included WNAR in contact with a station sending CW and claiming to be a UFO from Bata Viticuli. The WNAR broadcast ended

at 0104 but various bits of music, brief voices, open carriers continued off and on until 0159 when the WNAR guy said "hi" to someone. WNAR said send reports to POP'COMM. That won't get QSL's to your listeners, guys! Rausch had WNAR, too, at 0250 with a woman's giving the ID over a music loop and saying to "look for a coming broadcast." She suggested reports to the A\*C\*E and "Pirate Pages" bulletin.

Pat Murphy has been raking in the QSL's lately and reports he's just reached the 100 mark for pirates QSL'd. Pat recommends patience when it comes to QSL'ing the pirates. He recently verified Delta Tango 306 after a wait of some 15 months! Congrats, Pat. An enviable record, to be sure.

Don't forget to keep those reports coming my way so I can "spread the word" about what's out there on the air. I continue to seek letters from station operators with info about your stations, even photos of your set-ups. Both my readers and your listeners are interested in what's happening with your station.

Catch you again next month. Happy pirate chasing!

# SCANNING VHF/UHF

BY CHUCK GYSI, N2DUP

## MONITORING THE 30 TO 900 MHz "ACTION" BANDS

**T**he fury of the campaign season is over this month and many readers have had the opportunity to tune in this year's election on their scanners. Every time one of the presidential candidates visited a city, dozens of frequencies were pressed into service. For instance, Secret Service channels started buzzing several days prior to the candidate's arrival as advance teams prepared for a visit. Most of their communications are no longer intelligible because they are digitally encrypted.

In addition to the Secret Service, other area law enforcement frequencies are utilized during a visit. During an actual visit, a frequency dedicated to highway patrol in larger cities will come into use as motorcades speed from one location to another. The city police will be protecting overpasses and clearing the highway for rapid passage of the candidate. In addition to city patrols, state police troopers or highway patrol officers usually are pressed into service during a high-profile visit. Be sure to check their tactical channels for car-to-car communications during a visit.

And last but not least, news media channels will be in use. Reporters and camera operators will be following the candidates, so by tuning in, you'll keep on top of the action. One thing not to overlook, however, is that in addition to the frequencies used by your local news media, don't forget that the national news media is also covering the visit. You may want to tune around a bit to try to stumble across frequencies used by the national media. You may hear reporters from the networks' nightly news using radios during the visit.

You can bet that cellular phones will be in use a lot during a campaign stop, but there are laws protecting those conversations, right?

Tony Everhardt from Walbridge, Ohio, says he's noticed that many fast-food restaurants, department stores and grocery stores in the Toledo, Ohio area all have four- or five-element beams on their rooftops all pointed to the south. He's wondering what they are used for because it's driving him crazy determining what frequency they are on.

If you think you've discovered some secret radio network, you're half-right. However, the transmissions are one-sided and you can hear them simply by walking in the door of the business. Hear the background music? That's what those antennas are for. They are pointed at the tower of the FM broadcast station. The FM station transmits a signal on a subcarrier of its main signal and special receivers are located in the businesses to decode the signal. The background music then can be heard by customers. A company

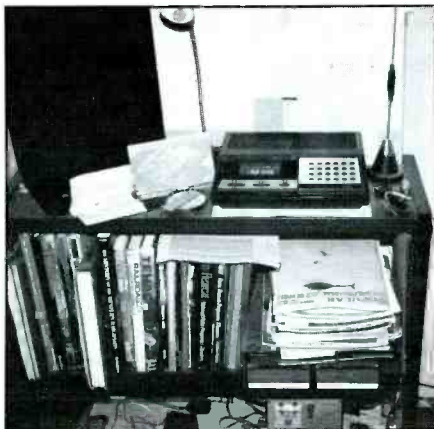

*This simple listening post is used by Thom McAdams, Registered Monitor, KCA6YU, of Lancaster, California. A Regency Z60 scanner is fed signals from a Radio Shack mobile magnetic mount antenna. Thom also has several other scanners not shown: Uniden Bearcat BC140, BC55XLT and BC560XLT. He's also a shortwave listener and on CB.*

provides the service, rents space on the FM station's frequency and tower and businesses subscribe to the service for their customers' enjoyment.

Officially, subcarrier programming (including services such as reading services for the blind, ethnic programming and even data and paging) is protected by the same law that makes it illegal to tune in cellular phone calls.

Rod Souza of Wailukai, Hawaii, offers some island frequencies that may be of interest to visitors to the 50th state: Oahu police - 155.430, 155.685, 155.370, 155.520, 155.250, 155.190 (car to car), 156.090 (SWAT); Oahu fire - 154.220, 154.340; Oahu ambulance - 453.925; 453.700; Maui-Molokai-Lanai police - 155.670, 155.550, 154.725, 155.730, 154.770, 155.790, 155.580; Maui-Molokai-Lanai fire - 155.925; Maui Molokai-Lanai ambulance - 453.250; Kahului Airport security - 155.760; Island of Hawaii (Big Isle) police - 154.695, 155.310, 155.610, 154.740, 154.785, 155.640; Island of Hawaii fire - 154.385, 154.310; Island of Hawaii ambulance - 154.385 (dispatch), 453.400 (MediComm); Kauai police - 155.415, 155.850, 155.670; Kauai fire - 155.670, 155.760; Kauai ambulance - 453.400; Kauai Airport security - 155.550; U.S. Coast Guard distress - 156.800; Coast Guard rescue - 157.150; Coast Guard advisory - 157.100;

Hawaii conservation/forestry (game wardens) - 154.995, 154.980; Civil Air Patrol - 148.150. If you're planning to visit the islands, this list should be a good start to check out the local action.

James L. Richardson of Littleton, Colo., writes to say he's interested in forming a Colorado/Rocky Mountain scanner group. If such a group gets going, there will be group outings and tours, frequency exchanges and possibly a statewide monthly newsletter.

If you're interested, send your name, address, phone number and any ideas on such a Colorado group to: James L. Richardson, 11391 Main Range Trail, Littleton, Colo. 80127-4049.

Jim also noticed in the July issue I mentioned that the Uniden Bearcat 250XLT was the only scanner that could log hits on frequencies. Jim points out that the Uniden Bearcat 300 also could do such searching. How quickly we forget some of those wonderful scanners of the past! What are your favorite scanners from years gone by?

J.B. Young III of Burgin, Kentucky, says he's been a devoted fan of POP'COMM for years. J.B. says he's a frequency sleuth and loves tuning around with his AOR AR2500 scanner. He used a frequency counter for trips in conjunction with his Realistic PRO-34 handheld scanner. Using his sleuthing gear, he was able to find two active frequencies at King's Island Amusement Park: 462.7625 and 463.675. The two channels are used for security and medical personnel. He said he had a ball listening to all the park's action on the air during his visit. J.B. says he's a member of the Burgin Christian Junior Police, which uses CB Channel 5 as its main channel, CB Channel 35 for special activities and 49.83 for mobile units.

J.B. continues to say he's hearing strange warble sounds from apparently different transmitter sites on 173.260. He wonders what he's hearing. Actually, the exact frequency is 173.2625 and it's a telemetry and radio-control frequency. For instance, a local utility might be using the frequency to monitor the level of water at its various towers, or a power company might use it to monitor power load, etc. That should explain what you're hearing.

J.B. also reports hearing even stranger noises on 144.280 in the 2-meter ham band. What I guess you may be hearing is hams transmitting in single sideband. Usually the frequency of 144.200 is used as a calling channel for hams using SSB on 2 meters. You may be hearing hams chit-chatting in sideband; Morse code also could be a possibility. You may want to check with a local

ham to see if he or she knows of anyone locally using that frequency.

Joe Galante, Registered Monitor, KNY2ADJ, says he was in Corfu, N. Y., and saw a village police car. He says he wasn't aware that the village had a police department, and that it's not listed in the phone book and cannot be found in frequency directories. He wants to know if this department might be used for dispatch purposes.

I couldn't find a frequency for them either, but I wouldn't be surprised if they were dispatched by a county dispatch center on county frequencies, or by an adjacent town's police department on that town's frequencies. You may need to do some more sleuthing to figure this one out.

Joe also inquires as to the frequency used by the police department in Akron, N. Y. I could find only a local government frequency on 153.785 that is licensed to that village. You might check there as they could be using that since the village is licensed by 20 mobiles and a base station on that frequency. Otherwise, I'd again check county or the neighboring town's frequencies.

Lastly, Joe wants to know what frequencies Genesee County, N. Y., is using for its new 800 MHz trunked system. The county is licensed for a trunked system on the following five frequencies: 851.0125, 851.4625, 851.9125, 852.3625 and 852.8125. Because there are 401 mobiles licensed for the system, it's possible that various county agencies are using the system, from police to county office workers. There are no frequency plans, as such, for trunked systems. Each time a mobile transmits, it's likely to come up on a different frequency; one frequency is used for data signalling telling the mobiles what channel to switch to. That way, the channels load up as usage dictates. The system in the county there can handle four simultaneous conversations at any given time. You'll have to be quick on the "scan" button to follow some conversations if you monitor the trunked system.

Bob Richley of Chula Vista, California, tells us about one major office supplier that is selling cordless phones for the office environment that not only operate on the 900 MHz band, but also scramble the conversation from the handset to the base unit. It serves as a warning that cordless phones are moving to the 900 MHz band for those who can afford them. Check the 902-928 MHz ham band for such activity. The hams have only secondary use of the band and other users can use it for low-power operating. Motorola also manufactures a cordless phone that uses regular 46 and 49 MHz frequencies, but also is fully scrambled to ensure privacy for the user.

What are you hearing on the airwaves? We welcome your frequency lists, photographs and questions here at POP'COMM. Write to: Chuck Gysi, N2DUP, Scanning VHF/UHF, Popular Communications, 76 N. Broadway, Hicksville, N. Y. 11801-2909. ■

## COMMUNICATION AT ITS BEST

AR900 \$219; AR1000XC \$399;  
AR2500 \$449; AR3000 \$969

Guaranteed Lowest Prices on  
AOR Radios

We also sell a variety of CBs,  
Radar Detectors, Shortwave Radios,  
& Accessories

For orders call: **1-800-33 TURBO**  
**Free Shipping**

## TURBO ELECTRONICS



366 N. Broadway  
Suite 310  
Jericho, NY 11802-8034



Questions Welcome (516) 938-1946

CIRCLE 136 ON READER SERVICE CARD

## SUPER-MINIATURE FM TRANSMITTER

NEW! POWERFUL! XST500  
SUPER-MINIATURE transmitter  
uses Surface Mount Technology  
(SMT)! Smallest high performance  
FM transmitter available anywhere.  
Transmits whispers to any FM  
receiver up to a mile away. Uses 9V  
battery. Complete, easy to  
assemble, kit with all SMT parts  
already assembled to circuit board.  
Call our free 800 order number and  
order one today!!

**XST500**



**\$39.95** CHECK, VISA, or MC  
COD ADD \$5.00

TECH INFO 1-602-829-8152  
ORDERS ONLY 1-800-336-7389

XANDI ELECTRONICS, Dept PC  
201 E Southern Ave, Suite 114  
Tempe, AZ 85282



Or write for  
catalog today!

CIRCLE 77 ON READER SERVICE CARD

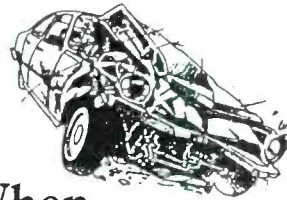

When  
seconds  
count,  
**REACT®** needs you...

...to summon help for an injured motorists, an elderly woman trapped in a fire, a trucker stranded in a blizzard, a drowning child!

As a REACT volunteer CB radio monitor you may be the only communications life-line for someone in serious trouble. You relay messages from those desperate for help to police or other emergency services.

Your REACT Team will also use CB and other radio services to provide safety communications for events like parades, marathons and even balloon races. The fellowship with other REACT members at Team meetings and annual conventions is an added bonus.

Volunteer. Join Today!

Add a New, Exciting  
Challenge to Your Life.  
Help Save Lives  
and Property!

**REACT International, Inc.**

Tel (316) 263-2100

FAX (316) 263-2118

P.O. Box 998, Wichita, KS 67201



CIRCLE 72 ON READER SERVICE CARD

## What To Do About Electrical Noise

If I had to say what aspect of DX'ing has gotten worse in the over 25 years I've been involved in the hobby, I can say it in a word: noise. There are a lot more sources of electrical noise today than in the past, and if anything the problem seems to be getting worse. In fact, for a lot of SWL's the big limiting factor in what can be heard isn't their receiver or antenna; it's their local noise situation. Frankly, the biggest drawback to DX'ing where I live is my local noise situation!

I wish I could tell you I've come up with some easy solutions to my noise problems, but I haven't. In fact, my situation seems to be getting a bit worse each year. But I do have some ideas that may help turn a hopeless noise situation into one that is merely painful. Such are the facts of life these days!

### Types Of Noise

Unfortunately, there's one type of noise that we're stuck with—static. Static is natural noise, mainly produced by lightning bolts in thunderstorms. Lightning bolts produce radio energy across a wide frequency range, which can propagate just like any other radio signal. Thus, you don't have to be near a thunderstorm to suffer from natural static; a cold front hundreds or even thousands of miles away can generate static at your location. Static has a distinctive "crashing" sound and generally gets worse as the receiving frequency drops, so 5 MHz is more bothered by static than signals at 10 or 15 MHz.

Static is an example of *impulse* noise. Impulse noise consists of brief bursts of noise strengths that can be over 10 times greater in strength than the signal you're trying to hear. A lot of impulse noise is from man-made sources, such as motors and automobile ignition systems. (If you've done much listening on frequencies above 20 MHz, you've no doubt heard the "pop-pop-pop" sound made by cars passing near your location). The infamous "Russian woodpecker" over-the-horizon radar system of a few years ago was a major impulse noise source.

Another type of noise might be called *hiss*. This is a steady noise from sources such as AC power lines or fluorescent lights. Hiss might be found in certain broad frequency ranges (such as from 7 to 8 MHz at a given location) but not on other frequencies.

So what's the big deal about different noise types? They're important because how we go about attacking noise depends upon the type and source.

### Inside Your Receiver

A lot of receivers today come equipped

with a circuit called a *noise limiter* or a *noise blanker*. Often these two terms are used synonymously. However, they're not the same circuits and they're not effective on the same types of noise.

Noise limiters are usually very simple circuits, usually consisting of a couple of diodes (often in the intermediate frequency section of the receiver) that are used to limit the peak amplitude of any signal you hear. These diodes "set a ceiling" for any signal, in effect shaving off the peaks of any noise pulse and limiting the strength of any noise to no greater than the average strength of any other signal you can hear. Just like the name implies, this circuit doesn't eliminate noise but instead limits it to a more tolerable level.

Noise blankers take a more active approach to noise reduction by sensing when a signal in the receiver's intermediate frequency stage exceeds the average signal strength by a certain amount. Such signals are usually noise, and the blanker actually silences the receiver for the duration of the noise signal. Noise blankers often have two selectable "bandwidths," with "narrow" most effective on signals like the "Russian woodpecker" and "wide" best on ignition and other broad impulse noise sources. As you might expect, noise blankers are more complex and expensive circuits than noise limiters.

So which is best? In my experience, noise limiters are best on steady noise sources or impulse noise sources that are not significantly stronger than the signal you're trying to receive. For most impulse noise sources, noise blankers are more effective.

The reason for this variance is because the noise blanker's great strength—the ability to totally silence the receiver during a noise pulse—is also its greatest weakness. Obviously, if a noise source is steady, a noise blanker would simply silence the receiver completely.

The other problem comes when a noise pulse is only slightly stronger than the signal you want to hear. Since a noise blanker only silences the receiver when the pulse is stronger than the average receiver by a certain amount, a noise blanker circuit will often ignore weaker but still bothersome pulses. But give a noise blanker an intermittent noise source significantly stronger than the signal you want to hear and it can deliver a clean, noise-free signal that a noise limiter can't begin to match. By the way, the noise blankers on many contemporary receivers have been designed to deliver best results when the receiver is in the USB or LSB mode. If noise is severe and you're having trouble hearing an AM signal, try switching over to a SSB

mode. The improvement in noise blanker performance in SSB can be dramatic.

There's no free ride with either noise limiters or noise blankers, however. Both will distort the audio of any signals you receive. Noise limiters are often worse than noise blankers in this regard, since a limiter will clip the peaks off desired audio as well as noise. The result is a "fuzzy" sound that can make weak signals hard to understand. But noise blankers have problems when there are a lot of noise pulses happening rapidly. Since the receiver is actually silenced during a noise pulse by a blanker circuit, the receiver audio can break up and become distorted. With both noise limiters and blankers, use the lowest setting that lets you hear a desired signal through the noise.

Noise blankers are a feature of today's better receivers, while noise limiters are mainly found on older or less expensive receivers. However, limiters can actually outperform noise blankers depending upon the circumstances. For example, I have a kilobuck receiver equipped with a state-of-the-art noise blanker that's fairly useless against a steady AC line noise that plagues my listening post. But, the noise limiters on a couple of my 30-year old vacuum tube receivers can reduce the line noise to a level that's still annoying but lets me listen to a desired station. That's why I use multiple receivers, some with noise limiters and others with noise blankers, and use whichever receiver does the best job of fighting the noise I'm experiencing at the moment.

### Tighten Your Skirts and Tweak A Knob

An often overlooked trick to reduce the effects of noise is to use the narrowest selectivity bandwidth possible when receiving a station. The key here is to use a receiver bandpass that's just wide enough to let an intelligible signal through. This improves the *signal to noise ratio* by getting rid of noise above and below the desired signal. You'll still have to contend with noise, but it should be less bothersome. If you have selectable bandwidths or other QRM-fighting features (such as IF shift or passband tuning), experiment with them a bit and you might be pleasantly surprised by the results.

Indoor directional loop antennas can be a big help if your noise problem can be traced to a single source, such as a power line or streetlight. Loop antennas have a figure-8 receiving pattern, allowing you to reject signals coming from a certain direction. You simply

rotate the loop until noise from a particular source or direction is eliminated or at least minimized; this is called a *null*. The problem here is that skywave signals from the direction of the noise are also reduced in strength. However, a loop is much more effective at nulling local noise sources than skywave signals and often a desired distant station can be heard from the same direction as the nulled noise. Loop antennas are not widely used by SWL's, but I suspect they'll become more popular as their benefits become more widely known.

An audio filter is *sometimes* useful in noise reduction. Audio filters are basically versatile, wide range tone controls, and while they don't do anything to reduce the actual noise level (unlike noise limiters and blankers) they can make some types of noise less bothersome.

Finally, what about grounding? For years, SWL's have been urged to use a ground system with their receiver because it supposedly reduces noise. All I can say is I'd really like to hear from someone who has actually found this to be true, especially with a modern solid-state receiver. After all, noise is radiated through the same radio spectrum as your desired signal, so it would logically follow that if a ground can reduce noise it should also reduce the desired signal! If you're currently using a ground—especially the single wire connected to a cold water pipe so celebrated in SWL folklore—try disconnecting it. Notice

any increase in the noise? Any decrease in signal strength? If you do, drop me a note and describe your ground system in detail!

### **But Sometimes You're Stuck . . .**

Despite your best efforts, you may be faced with a noise problem you can't remedy with your receiving equipment and techniques. Then what?

One of the best ways to find out where a noise is coming from is to use an ordinary portable AM radio. The internal loopstick antenna used for AM band reception has the same directional characteristics as a full-size loop antenna, and you can use it to locate a noise source.

If the noise is coming from a source belonging to your local government or public utility—such as a power line, telephone pole, or traffic light switch—you may be able to do something about having the noise reduced. In many cases, noise radiation from such sources indicates a problem (like a leaky power line insulator) that the utility would like to know about. If you complain to the utility or other agency, be prepared to explain your problem in technical terms ("I'm experiencing a lot of broadband RF noise radiation from your power pole, which I've been able to trace using direction-finding techniques. It seems you might have a problem with energy leak-

age from it."). You should also be persistent (but always polite) in asking for relief. The "customer service" departments at many utilities and government agencies is anything but, and you'll often find yourself talking to someone whose main goal is to convince you the problem lies in your head and not their facilities. Your best shot is to get directly through to someone in the engineering and facilities maintenance departments. These people often have a lot of professional pride in seeing such problems resolved and will take your complaints seriously. However, it may not always be possible to provide the amount of noise reduction you want.

Items in your home like light dimmers, personal computers, timers, motors, and similar related electrical fixtures and devices are common sources of noise. The solution is simply to turn them off when you want to listen. Unfortunately, it's often possible for such items in neighboring homes to cause you noise, so you might have no recourse unless you're on friendly terms with your neighbors. However, most noise sources are intermittent, and there will be periods of the day when the noise will not be present.

Unfortunately, there will be some cases when you are unable to reduce noise to an acceptable level no matter what you do. This is a sad fact of life in many urban and suburban areas. The only solution that works in such cases is to move! ■

# THE FUTURE OF AMATEUR COMMUNICATIONS

Once in a lifetime, a transceiver is introduced that's so extraordinary and innovative that it opens a totally new era in HF communications. ICOM's pacesetter IC-781 proudly exhibits that hallmark achievement with futuristic designs and features of true legendary proportions. Whether DX'ing, contesting, pioneering new interests or enjoying unquestionable top-of-the-line performance, the IC-781 is indeed today's standard of excellence!



**Multi-Function Five Inch CRT.** Displays frequencies, modes, memory contents, operating notes, RIT, two menu screens, plus a panoramic view of all signals in a selected range. A portion of the screen also serves as a display for data modes like RTTY, AMTOR, and PACKET.

**Dual Width Noise Blanker** includes MCF filter plus **level and width controls** to eliminate pulse and woodpecker noise with minimum adjacent-signal interference.

**Unique Spectrum Scope.** Continuously indicates all signal activities and DX pileups with your operating frequency in the center. Selectable horizontal frequency spans of 50, 100, and 200kHz for each side of the frequency you're listening to. Vertical range indicates relative signal strengths. A contesters' dream!

**Incomparable Filter Flexibility.** Independent selection of wide and narrow SSB filters plus CW filters. Second and third CW IF filters are independently selectable!

**Dual Watch.** Simultaneously **receives two frequencies in the same band!** Balance control adjusts VFO A/B receive strength levels. You can check additional band activity, even tune in your next contact, while in QSO without missing a single word!

**DX Rated!** 150 watts of exceptionally clean RF output. Easily drives big amplifiers to maximum power.

**Twin Passband Tuning** with **separate controls for second and third IF stages!** Increases selectivity and narrows bandwidth, independently varies low and high frequency response, or functions as IF shift.

**A Total Communications System!** Includes built-in 100% duty AC supply, high speed automatic antenna tuner, iambic keyer, semi-automatic or full QSK CW break-in to 60 wpm, Audio Peaking Filter (APF), RF speech processor, multiscanning, 105dB dynamic range, all-band/all-mode receiver with general coverage, and much more!

**ICOM Dependability.** The phenomenal IC-781 is built for action and backed with the most extensive warranty in the industry.

See the IC-781 at your local ICOM dealer.

**ICOM**  
First in Communications

ICOM America, Inc., 2380 116th Avenue N.E., Bellevue, WA 98004  
Customer Service Hotline (206) 454-7619  
3150 Premier Drive, Suite 126, Irving, TX 75063  
1777 Phoenix Parkway, Suite 201, Atlanta, GA 30349  
ICOM CANADA, A Division of ICOM America, Inc.,  
3071 - 85 Road, Unit 9, Richmond, B.C. V6X 2T4  
All stated specifications subject to change without notice or obligation.  
All ICOM radios significantly exceed FCC regulations limiting spurious emissions. 781188.

# POP'COMM'S World Band Tuning Tips

November - 1992

Freq.	Station/Country	UTC	Notes	Freq.	Station/Country	UTC	Notes
2390	LV de Atitlan, Guatemala	0300	SS	5935	R. Riga, Latvia	0300	Latvian
2410	R. Enga, Papua New Guinea	1100		5960	R. Japan via Canada	0100	
3200	Trans World Radio, Swaziland	0300		5975	R. Macarena, Colombia	1000	SS
3205	R. Sanduan, Papua New Guinea	1000	Pidgin	5995	R. Melodia, Peru	0500	SS
3215	R. Oranje, South Africa	0300	EE/Afk	6010	R. Mil, Mexico	0300	SS
3235	R. Clube Marila, Brazil	0200	PP	6010	R. Mil Cuarenta, Venezuela	0830	SS
3240	R. Luz y Vida, Honduras	0230	SS	6015	R. Union, Peru	0800	SS, ex-6115
3260	R. Madang, Papua New Guinea	1100		6020	R. Australia	0730	
3270	Ecos del Oriente, Ecuador	1030	SS	6030	R. Globo, Brazil	0000	PP
3275	R. So. Highlands, P/New Guinea	1200		6045	R. Polyus, Russia	0400	RR
3295	INBS, Iceland	0630	Icelandic	6050	R. Nigeria, Ibadan	2230	
3300	R. Cultural, Guatemala	0200	SS	6055	Spanish National Radio, Spain	0430	SS
3315	SLBS, Sierra Leone	0600		6060	R. Nacional, Argentina	0930	SS
3320	R. Orion, South Africa	0245		6070	CFRX, Canada		24hrs
3225	R. Maya, Guatemala	1100	Ind. langs	6085	Deutsche Welle, via Canada	0530	GG
3360	LV de Nahuala, Guatemala	0305	s/off, indian	6115	R. Universidad, Mexico	0500	SS
3375	R. Dourados, Brazil	0330	PP	6120	R. Globo, Brazil	0900	PP
3380	R. Chortis, Guatemala	0230	SS	6130	CHNX, Canada		24 hrs
3385	R. E. New Britain, P/New Guinea	1100	Pidgin	6135	R. Aparecida, Brazil	2330	PP
3395	R. East. Highlands, P/New Guinea	1200		6135	Swiss Radio Int'l	0230	
3500	LV de Guainia, Colombia	1030	SS	6140	Australian Bc Comm	1100	
3880v	R. Free Bougainville	0800		6165	Swiss Radio Int'l	0415	
3905	VOA Relay, Germany	0329	sign on	6180	R. Nac. Amazonas, Brazil	2200	PP
4331	R. Horizonte, Peru	1100	SS	6180	R. Havana Cuba	0400	EE
4409	R. Eco, Bolivia	0130	SS	6210	European Christian R., Italy	0630	
4600	R. Perla del Acre, Bolivia	0200	SS	6210	Croatian Radio	0000	Croatian/EE
4680	R. Nacional Espejo, Ecuador	0000	SS	6245	Vatican Radio	0430	
4740	R. Yunost, Russia	0200	RR	6275	Radio Patria Libre	0115	Col. cland.
4755	R. Ed. Rural, Brazil	0000	PP	6300	R. Venceremos, El Salvador	0230	SS
4765	R. Congo	0355	FF	6560	Iraq Republic Broadcastin	0130	AA
4770	R. Nigeria, Kaduna	0500		6803	R. Ondas del Mayo, Peru	1100	SS
4795	CRTV Douala, Cameroon	0500		6840	CPBS, China	1200	CC
4795	LV de las Caras, Ecuador	0400	SS	6910	R. Dublin Int'l, Ireland	0730	
4805	Rdf. Amazonas, Brazil	0930	PP	6940	Yunan PBS, China	1130	CC
4809	Rdf. Libertad, Bolivia	1000	SS	7125	IRRS, Italy	0500	
4830	R. Tachira, Venezuela	0200	SS	7130	VOFC, Taiwan	1030	CC
4840	R. Andahuaylas, Peru	0100	SS	7160	RTM, Malaysia (Sarawak)	1100	
4850	CRTV, Cameroon	0430	FF/EE	7190	Rep of Yemen Radio, Aden	0300	sign on, AA
4865	LV del Cinaruco, Colombia	0900	SS	7205	Cyprus Bc Corp.	2215	2245 wknds
4865	Gansu PBS, China	1130	CC	7215	Voice of the UAE	2300	
4871	R. Centinela del Sur, Ecuador	0400	SS	7220	All Union Radio, Russia	0100	RR
4875	Super Radio, Brazil	0235	PP	7235	Deutsche Welle, Germany	0400	AA, via Malta
4885	Ondas del Meta, Colombia	1000	SS	7240	Croatian Radio, Croatia	0300	
4890	R. France Int'l, Gabon relay	0400	FF	7255	V of Nigeria	0500	s/on
4890	NBC, Papua New Guinea	1100		7260	Sudwestfunk, Germany	0100	GG
4900	R. Centinela del Sur, Ecuador	1100	SS	7265	VOA Relay, Botswana	0300	sign on
4904.5	R. National, Chad	0427	sign on, FF	7345	R. Czechoslovakia	0300	
4915	R. Cora, Peru	1000	SS	7365	KNLS, Alaska	0800	
4915	R. Anhanguera, Brazil	0700	PP	7370	R. Ala, Russia	2330	RR
4920	R. RICA, Nicaragua	1030	SS	7390	Deutsche Welle	1200	via USSR
4934	Kenya Broadcasting Corp.	0300		7400	R. Yerevan, Armenia	0338	
4940	R. Continental, Venezuela	0200	SS	7400	R. Belarus, Belarus	0030	Byelorussian
4945	R. RSA, South Africa	0357	sign on	7465	Reshet Bet HS, Israel	0100	Hebrew
4955	R. Marajoara, Brazil	0800	PP	7475	RTV Tunisienne, Tunisia	0400	AA
4960	R. Federacion, Ecuador	0059	close, SS	7490	WCJR, Kentucky	0300	
4965	R. Alvorado, Brazil	0915	PP	9022	VOIRI, Iran	0030	EE
4980	Ecos del Torbes, Venezuela	0200	SS	9115	R. Continental, Argentina	0030	SS feeder
4985	R. Brazil Central, Brazil	0000	PP	9265	Icelandic Nil Bc Svc	0730	EE
4990	Hunan PBS, China	1200	CC	9280	Voice of Asia, Taiwan	1000	CC
5005	R. Libertad, Bolivia	0100	SS	9345	R. Pyongyang, N. Korea	1300	
5020	LV del Upano, Niger	0500	FF	9395	V of Greece	1900	GG
5030	AWR, Costa Rica	0100		9425	KFBS, Saipan	1500	RR
5047	RTV Togolaise	0600	FF	9445	Voice of Turkey	2330	TT
5055	TWR, Swaziland	0400	GG/EE	9475	R. Australia	0900	
5062	R. Progreso, Ecuador	0230	SS	9475	R. Cairo, Egypt	0200	
5075	Caracol, Bogota, Colombia	0400	SS	9480	TWR, Monaco	0645	
5085	Croatian Radio, Croatia	0300	//6210	9505	R. Record, Brazil	2300	PP
5256	RRI Sibolga, Indonesia	1330	II	9505	R. Yugoslavia	2230	to Europe
5850	R. Patria Libre, anti-Colombia	0030v	SS +	9520	R. Veritas Asia, Philippines	1200	
5882	Vatican Radio	0000		9530	KHBI, Saipan	1400	



Freq.	Station/Country	UTC	Notes	Freq.	Station/Country	UTC	Notes
9535	Trans World Radio, Bonaire	0300		11945	Iraq Republic Broadcasting	0030	AA
9540	R. Educadora da Bahia, Brazil	0930		11955	Voice of Turkey	0400	TT
9545	R. Tirana, Albania	0530	sign on	11955	BBC relay, Oman	0130	
9555	R. Portugal	0230		11960	R. Sweden	1130	
9560	FEBC-Russia	0900	RR	11960	RTV Malienne, Mali	0900	FF
9560	R. Jordan	2200	AA	11965	V of the UAE	1800	AA
9565	R. RSA, South Africa	1630		11970	R. Havana Cuba	0130	
9570	R. Korea, S. Korea	1400		12000	R. Ukraine	0030	
9580	R. Yugoslavia	0130		12015	R. Ulan Bator, Mongolia	1200	part EE
9580	R. Tirana, Albania	0230		12095	BBC, England	2100	
9585	HCJB, Ecuador	0600	German	12105	Voice of Greece	2230	Greek
9595	R. Tanpa, Japan	1000	JJ	13620	R. Kuwait	2000	
9600	R. UNAM, Mexico	0300	SS	13625	KHBI, Saipan	1400	
9605	Vatican Radio	0230		13630	R. for Peace Int'l, Costa Rica	0200	
9610	R. Norway Int'l	0200		13635	Swiss Radio Int'l	2130	
9615	R. Veritas Asia, Philippines	1433	sign on	13650	R. Pyongyang, N. Korea	0000	
9615	R. Cultura, Brazil	2330	PP	13655	BRT, Belgium	2330	
9645	R. Norway Int'l	0300		13666	Voice of Europe, Italy	0100	
9650	Swiss Radio Int'l	0130		13675	UAE Radio, Dubai	2000	AA
9655	R. Australia	0920		13685	Swiss R. Int'l	0700	
9665	R. Marumby, Brazil	2300	PP	13720	KSDA, Guam	1800	
9670	Deutsche Welle, Germany	0530	via Antigua	13755	R. Australia	1600	
9690	R. Romania Int'l	1930		13855	INBS, Iceland	2000	Icelandic
9700	R. New Zealand	1030		15050v	R. Patria Libre	0045	SS, cland.
9705	R. Portugal	0230		15070	BBC	1400	
9710	Radio Australia	0727	s/on	15084	VOIRI, Iran	0430	Farsi
9725	Adventist World R., Costa Rica	1250		15095	R. Damascus, Syria	2115	
9735	R. Oman	1945	AA	15100	Kol Israel	2130	EE
9735	R. Nacional, Paraguay	2300	SS	15110	Spanish National Radio	2000	SS
9745	R. Cairo, Egypt	0200		15125	AWR, Kuybishev, Russia	1700	
9746	R. Bahrain	2000	AA QRM-HCJB	15150	Iraq Republic Radio	0030	
9750	R. Korea, So. Korea	1200		15160	R. Sofia, Bulgaria	0400	
9750	R. Kiev, Ukraine	0300		15170	R. Beijing	2200	
9755	R. Monte Carlo, Monaco	0400	AA	15185	R. Finland Int'l	2300	
9760	R. Tirana, Albania	0130	Albanian	15195	R. Japan	0500	
9760	VOA relay, Philippines	1330		15200	R. Bangladesh	1230	EE
9770	R. Beijing, China	0000	via Mali	15208	R. Bangladesh	1230	
9779	Rep. of Yemen Radio	0301	s/on, AA	15210	R. Beijing	1200	
9830	Croatian Radio	0600		15235	V of Great Homeland, Libya	2000	AA
9830	Voice of Hope-Asia, Palau	1100		15260	VOIRI, Iran	0230	sign on
9835	AWR, Russia	2300		15275	All Indian Radio	1200	
9870	BSKSA, Saudia Arabia	2000	AA	15320	UAE Radio, Dubai	2300	
9870	R. Ukraine	0100		15325	R. Japan	1500	via Fr. Guiana
9877	R. Santiago, Dom. Rep.	0356	s/off, SS	15340	Iraq Rep. Broadcasting	0230	EE/AA
9885	Swiss Radio Int'l	0200		15345	RT Morocaine, Morocco	1500	AA
9905	BRT, Belgium	0900		15345	Trans World Radio, Bonaire	1230	
9950	All India Radio	2200		15345	RTM, Morocco	1400	Berber
9930	BRT, Belgium	2355	close	15350	R. Nacional, Ecuador via HCJB	1800	SS
10059	V of Vietnam	1330	VV	15350	R. RSA, S. Africa	0300	sign on
11520	R. Ukraine	0200		15400	Radio Finland Int'l	1500	
11550	RTT Tunisia	1800	AA	15425	SLBC, Sri Lanka	2330	Mon.
15588	Kol Israel	1800		15445	Radiobras, Brazil	1159	sign on
11620	All India Radio	2000		15475	Africa No. One, Gabon	1500	FF
11620	Vatican Radio	0145	SS	15476v	R. Nac. Archangel, Antarctica	2230	SS
11635	R. Netherlands via Madagascar	0100		15480	V of UAE	1600	s/on, AA
11645	V of Greece	0140		15495	Ukrainian Radio	0600	Ukrainian
11650	KTWR, Guam	1500		15505	R. Kuwait	2245	AA
11675	R. Moscow	2000	sign on	15530	R. France Int'l, via Hungary	0630	FF
11705	R. Sweden	2330		15550	Central People's Bc Str, China	0230	CC
11710	RAE, Argentina	0100		15585	Kol Isreal	2130	
11715	R. Beijing, China	0330	via Mali	15670	CPBS, China	0000	
11715	R. Sofia, Bulgaria	0300		15750	R. Russia	1800	RR
11725	VOA relay, Botswana	0200		17500	RTT Tunisienne, Tunisia	0500	AA
11735	R. Japan, via Gabon	2300		17565	R. Australia	1600	
11745	R. Norway Int'l	2300	EE/NN	17605	R. Yerevan, Armenia	0300	Armenian
11745	Radiobras, Brazil	1200		17650	R. France Int'l, via China	1430	
11755	R. Finland Int'l	0130		17690	R. Minsk, Belarus	0030	
11755	CBS, Taiwan	1430	CC	17705	R. Pakistan	0200	Urdu
11780	Deutsche Welle, Germany	0600		17725	V of the Great Homeland, Libya	2100	AA
11780	Radio Austria Int'l	1530		17730	Vatican Radio	0628	s/on
11790	R. Vilnius, Lithuania	2300		17730	R. Alma Ata, Kazakstan	1830	
11795	R. Denmark, via Norway	2300		17740	R. Federal Yugoslavia	1200	
11800	RAI, Italy	0100		17740	R. Sweden	1300	EE
11810	R. Korea, S. Korea	0600		17740	R. Iraq Int'l	2330	
11810	R. Jordan	1400	AA	17760	BSKSA, Saudi Arabia	0500	AA
11815	R. Brazil Central	0800	PP	17770	R. New Zealand Int'l	0445	
11820	R. Tirana, Albania	0330	s/on	17795	Radio France Int'l	1500	FF
11827	R. Tahiti	0500	FF/TT	17185	R. Tashkent, Uzbekistan	1200	EE
11830	New Wave Radio, Russia	0700		17815	R. Cultura, Brazil	2330	PP
11850	R. Tbilisi, Georgia	0445		17855	V of UAE, Abu Dhabi, UAE	2200	
18855	R. Beijing	1300		17860	Qatar Bc Service	1300	AA
11865	R. Japan	1400		17890	UAE Radio, Dubai	0215	
11870	R. Yugoslavia	0040		17890	Spanish National Radio	1200	
11880	R. Galaxy, Russia	2130		17895	HCJB, Ecuador	24hr	SSB
11895	Voice of Turkey	2330		21515	Radio Portugal	1630	
11905	RAI, Italy	0230	II	21580	R. Pilipinas, Philippines	0230	
11910	R. Budapest, Hungary	0200		21675	R. Kuwait	1600	AA
11920	R. RSA, South Africa	0500	PP	21705	R. Norway Int'l	2100	EE/NN
11925	R. Bandeirantes, Brazil	0000	PP	21810	R. RSA, So. Africa	0230	
11945	R. Space, Russia	1500	RR				

## Small Loops For Low Frequency DX'ing

The small loop antenna has a lot of potential for low frequency (VLF through tropical bands) DX'ing. The loop is so useful because it possesses a bi-directional, roughly figure-8, response pattern (Fig. 1) with very sharp, very deep nulls. The nulls, or direction of minimum response, are found when the antenna is broadside to the arriving radio signal. The peak response, or main lobes, are found when the sides of the loop are facing the arriving signal. This is counter-intuitive to many people, for they assume that the max response occurs when the loop is broadside (as it is when the antenna is a ferrite loopstick). But on small loop antennas, the deep null is broadside to the loop.

The loop was originally used for radio direction finding and finding hidden transmitters. But for low-band DX'ers, there is another use: eliminating strong, local interfering signals to reveal hidden DX signals on the same, or adjacent, channels. I built one loop, and tried two commercial models (one a loopstick).

A loop antenna must have certain attributes. First, it must be small relative to the wavelength ( $\lambda$ ) of the desired signals. The usual rule is a total wire length of  $< 0.22\lambda$ , although most authorities argue for a wire length between  $0.08\lambda$  and  $1\lambda$ . At the frequencies where loops are best used, this requirement is not hard to meet because a wave-

length is scores of dozens of feet. Another requirement is that the diameter (or edge length if not circular) be at least five times the width of the winding (if multiturn) or the diameter of the wire (if single turn). For most low frequency DX'ing a multiturn loop is needed.

### A Homebrew Embroiderloop

Fashioning the loop is usually a bit of a chore, and winding even a dozen or so turns on a large form can be daunting—especially since the turns keep falling off the form. I hit upon an idea that allowed me to make a multiturn transformer loop (Fig. 2A) in which the outer loop (L1) was a 14-turn loop, and the receiver coupling loop (L2) was 2-turns. The loop is made of 16-conductor ribbon cable of the sort used by computerniks. Two wires in the center of the bundle (grey and white) are used for L2, while all the rest are used for L1. The form is a 14-inch embroidery or needle-point hoop, which I bought from a craft store for \$1.49. It consists of two concentric, close-fitting wooden hoops. The inner hoop is continuous, while the outer hoop is broken at one point. A screw and two tabs holds the ends together, and adjust for size. In embroidery, the fabric is placed between the two hoops and secured with the screw; in our loop antenna the 16-conductor ribbon cable is sandwiched into the space between inner and

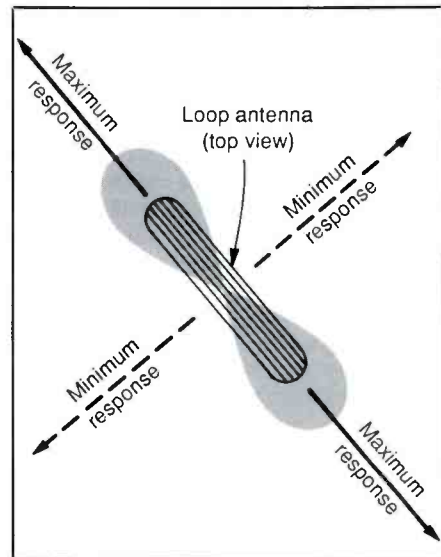

Figure 1—Maximum and minimum response directions for a small wire loop antenna.

outer hoops. (Fig. 2B). The conductors of the cable are cross-connected in the manner shown in Fig. 2C to form one continuous coil.

The inner loop is connected to a length of coaxial cable, which carries signal to the radio receiver. The outer loop is connected to a variable tuning capacitor (C1 in Fig. 2A). I

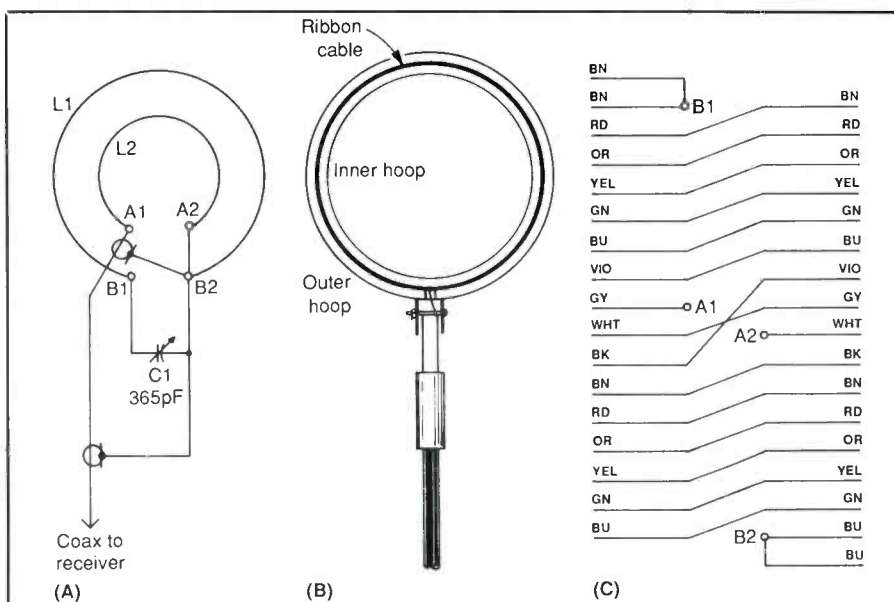

Figure 2—Homebrew loop antenna: A) Equivalent circuit, B) Construction using an embroidery hoop to hold 16-conductor ribbon cable; C) wiring connection for the 16-conductor ribbon cable.



Figure 3—Actual loop as constructed.

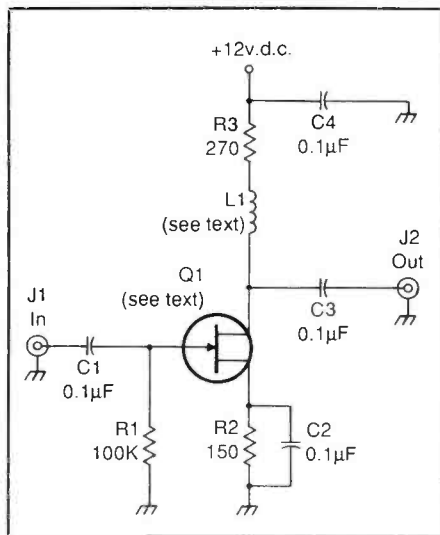

Figure 4—JFET-based loop amplifier.

found that a 365-pF "broadcast band variable" capacitor was sufficient to tune the loop in all sections of the AM band. But some people tell me that two or three sections of 365 pF may be needed in some cases where fewer turns are used. Figure 3 shows the completed loop antenna.

Loop antennas don't pick up very much signal, even on good days. If the receiver lacks the sensitivity to make up for the difference, then a loop amplifier is needed. It should have a gain of 10 to 25 dB throughout the range of interest. For the AM broadcast band I found that the circuit of Fig. 4 worked well. The circuit provided about 5 dB gain when L1 was removed and R3 connected directly to the drain of the JFET transistor. When L1 was used, the performance was best on the low end of the band when a 1 mH choke (Digi-Key part no. TK-4312) was used for L1. However, the performance was less, but more consistent across the band, when a 220 µH coil (Digi-Key part no. TK-1019) was used. The transistor used is an MPF-102 JFET, although either ECG-312 or NTE-312 will work as substitutes (and are generally available in local parts distributors).

## Commercial Loop Antenna

Figure 5 shows two commercial loop antennas that I've used. Both are made by Palomar engineers (Box 455, Escondido, CA 92025; 619-747-3343). Both loops are connected to the Model LA-1 loop amplifier. The square loop in Fig. 5A is the Palomar Model HF-1, which is intended for high frequency shortwave use. It is made with a PVC housing, and plugs into the top of the loop amplifier. The loop in Fig. 5B is a loopstick antenna, Model BCB, that is designed for use in the AM broadcast band. Other models are available for other frequencies from VLF through HF. Both antennas are capable of being rotated in azimuth (as is proper for a loop), but the BCB antenna is also capable of being

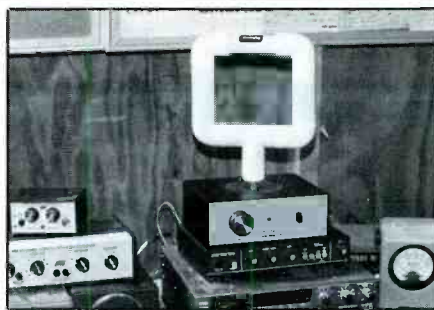

Figure 5— A) Palomar Engineers HF-1 small loop; B) Palomar BCB loopstick. Both are connected to an LA-1 loop amplifier.

adjusted in elevation. This allows you to compensate for angle of arrival of sky wave signals. Both antennas performed well, and for those that don't want to mess with making one, may be the best solution for the cost.

Using a loop is simple, especially when the object is to reduce the signal strength of a co-channel of adjacent channel interfering

signal. Loops work best in this manner on ground wave signals. You will be surprised at how much more "sensitive" your AM band DX receiver seems when the loud locals are cut down to size! Adjust the position of the loop to minimize the interfering signal, and be surprised what lays underneath, especially at night. ■

## CB RADIO OWNERS!

We specialize in a wide variety of technical information, parts and services for CB radios. 10-Meter and FM conversion kits, repair books, plans, high-performance accessories. Thousands of satisfied customers since 1976! Catalog \$2.

**CBC INTERNATIONAL**  
P.O. BOX 31500PC, PHOENIX, AZ 85046

## SURVEILLANCE

**COUNTERSURVEILLANCE** Electronic Devices  
Miniature Transmitter Kits... \$29.95  
Voice Changers, Phone Scramblers, Vehicle Tracking, Phone  
Recording Systems, Bug & Phone Tap Detectors, & More!

**CALL IDENTIFIER device** - displays callers phone number  
before you answer with date & time of call...\$49.95

FOR CATALOG SEND \$5.00 TO...  
**EDE** P.O. Box 337, Buffalo, NY 14226 (716) 691-3476

## Get All The Facts On Users In Your Area

### FCC License-Holder Information And Toll-Free Dial Access Services

- Custom Frequency Searches by Coordinates, State, County, Zip, Specific Frequencies, Category of FCC Service or Licensee Names
- All Frequencies • All Types of FCC Services
- You Get - Frequency, Service Type, Transmit Power, Call Sign, Site Latitude & Longitude Elevation, City, County, and State, License Expiration Date and Licensee Name & Address
- Available as a Printout or on Floppy Diskette
- Retrieve FCC License-Holder and FAA Airport Information on your PC from CET's Extensive Database using our 800# Dial Access Service

Write, Call Or Fax For More Information

### COMMUNICATIONS ENGINEERING TECHNOLOGY INCORPORATED



1001 S. Ridgewood Avenue  
Edgewater, Florida 32132  
Phone (904) 426-0014  
Fax (904) 426-0099  
800-445-0297

**C.E.T., INC.**

CIRCLE 141 ON READER SERVICE CARD

FREE  
SAMPLE  
COPY!

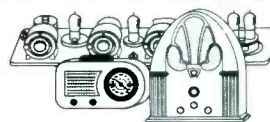

## ANTIQUE RADIO CLASSIFIED

Antique Radio's Largest-Circulation  
Monthly Magazine

Articles - Classifieds - Ads for Parts & Services  
Also: Early TV, Ham Equip., Books,  
Telegraph, 40's & 50's Radios & more...

Free 20-word ad each month. Don't miss out!

1-Year: \$27 (\$40 by 1st Class)  
6-Month Trial - \$15. Foreign - Write.

A.R.C., P.O. Box 802-T7, Carlisle, MA 01741

## Secret Frequencies

### The Remote Computer Scanning System™

Turn those hours of manually searching for secret frequencies over to RCSS™. The RCSS™ significantly enhances the ICOM™ R7000 receiver capabilities by providing automated PC control over receiver scanning & memory functions.



#### Features

- Automatic detection and storage of active frequencies & other info while scanning.
- User specified Tuning Steps from 10-100 MHz.
- Scan Mode, Class of Service, or Type of Unit.
- Scanning resumes upon loss of carrier.
- Memory capacity: 1,000 frequencies.
- Monitor half-duplex communications.
- Mouse/Keyboard driven graphic user interface.

### SYSTEMS & SOFTWARE

4639 Timber Ridge Drive, Dumfries, VA, 22026-1059 USA  
(703) 680-3559, Fax: (703) 878-1460. RCSS™ is available for both IBM compatible & Macintosh computers.

CIRCLE 142 ON READER SERVICE CARD

## 27 MHz COMMUNICATIONS ACTIVITIES

**T**he new Model 27-SPS is a 40-channel full-power CB handheld transceiver from Maxon Systems Inc. The concept of the 27-SPS is that it is a high-quality transceiver sold at a relatively low price (MSRP of \$159) because it comes packaged for those who don't require a full line of accessories that are standard with a more expensive unit Maxon offers.

The 27-SPS comes with a belt clip, detachable rubberized antenna, cigarette lighter power cord, and slide-on alkaline battery pack. Optional accessories include an external speaker/mic, extra alkaline battery pack, telescopic antenna, mag mount mobile antenna, rechargeable battery pack and charger, and a mobile charger.

This unit has a dual conversion receiver with noise limiting circuitry, instant Channel 9 switch, and a high/low transmitter power switch for longer battery usage.

The 27-SPS comes from Maxon Systems Inc., 8610 N.W. 107th Terrace, Kansas City, MO 64153. You can obtain more information from them, or you may circle 105 on our Readers' Service.

### Rule Clarification

Last March, the Federal Highway Administration (FHA) asked the FCC to permit them to go ahead with a plan to develop and transmit over CB stations warnings of scheduled openings of the Woodrow Wilson Bridge. These would be one-way transmissions lasting about 15-seconds each, and repeated every three minutes. The hope was that these transmissions might avoid accidents, such as the fatal one that occurred in October of 1991.

The FCC's position was that special permission for these activities was not required since they were already permitted under the existing CB Regulation 95.418 (CB Rule 18) concerning CB emergencies and traveler assistance. However, in order to clarify the rules to avoid any possible further confusion or question as to whether this might be permitted, the FCC has now added 95.418(d), specifying, "You may use your CB station to transmit one-way communications concerning highway conditions to assist travelers."

We can't figure out what all the fuss was about. Looks like this newly clarified regulation merely defines *smokey reports*, and those have been going on for at least 16 years. Hey FHA, get the cotton out of your ears. It's time to wake up and smell the diesel fuel!

### Things Have Changed

A lengthy letter from Jeff Kroboth, Dobbs Ferry, New York, tells us that he's recently gotten back on 27 MHz after an absence of



Maxon's 27-SPS handheld is the no-frills version of a more expensive unit.

many years. In a nutshell, he had originally been active in CB in the 1960's, but now Jeff is back and rather astonished at what he's found in comparison to the CB service he once knew. He's heard a lot of foul language, there are people fooling around on Channel 9, the truckers on Channel 19 won't let him "break," and he can't even locate *S9 Magazine*. He wants to know what happened.

We are sure there are many other people also asking that same question, Jeff, and they never left CB. The best guess we can stab at is that 25 years have passed. Few things are as they were in the 1960's—prices, taxes, cars, or the world in general. Some changes were for the better, and some for the worse. And so it has been with 27 MHz, too. There are lots of good things about today's CB, including the fact that the equipment we are using is smaller, better designed, more versatile, and it operates on 17 more channels than the CB gear of the 1960's. Give it a try!

### Bestseller

It was my privilege to have been invited to write the foreword to Kevin Ross' bodacious new bestseller, the 151-page *CB Radio Hacker's Guide*. Boy, talk about CB equipment being versatile! Kevin's book covers more than 200 current and recent CB radios from the likes of Cobra, Realistic, Uniden, President, Courier, SBE, G.E., and Sears.

Through Kevin's own text and clearly drawn diagrams and charts, you'll see how to squeeze the last drop of potential and per-

formance from these sets, whether AM or SSB. This is done by "peaking and tweaking" to obtain maximum available output and operation, by activating dormant features that were there all the time but not turned on at the factory, and by adding features that the factory didn't think of including. Kevin shows where to cut, what to adjust, and if something needs to be added.

This is a terrific book! When you're through, you have a lot more set than you started out with, and that's what we call versatile equipment.

*The CB Radio Hacker's Guide* is \$18.95, plus \$3.50 for UPS shipping (1st Class Mail to AK, HI, PR, VI, military addresses, and Canada) from its publisher, CRB Research Books, Inc., P.O. Box 56, Commack, NY 11725. Residents of NY State, please add \$1.91 tax. You can also get this new book from many leading dealers in communications equipment and books.

### Assaulted Batteries

Readers frequently ask about the care and feeding of rechargeable batteries, since these are commonly found in CB handhelds and scanners. Yes, there are some things you'll want to keep in mind when dealing with these batteries.

Most of us grew up familiar with rechargeable batteries like the ones used in cars, trucks, and boats. These are lead-acid type batteries. We know that one of the facts of life when dealing with these rechargeables is letting them drain down to a weak or dead state is a bad thing, and shortens the useful life of the battery. The good thing is to recharge or trickle charge such a battery so as to always keep it as close to a full charge as possible.

The kind of rechargeable batteries used in radios, however, are Nickel-Cadmium (Ni-Cd) types. It's confusing to many people to realize that Ni-Cd's are best dealt with quite differently than lead-acid rechargeable car batteries.

To put it in basic terms, in some ways, Ni-Cd batteries become personalized to what they think their owner's needs are. They get something like a memory regarding how much of a charge they are going to take. This is based on how much of a charge they have usually needed to take in the past. Let's say, just for example, Ni-Cd's in your radio might have an ideal potential for providing five hours of service. But you like to charge them up after only two hours of use. After a while the Ni-Cd's in that radio will learn that two hours of charge is all they will probably ever need to take.

Problem is, someday you will need your radio for a three hour or five hour stint. You



The venerable E. F. Johnson Viking Messenger CB radio. It was one of the best work horse units from the early 1960's.

then realize that your Ni-Cd's balk at performing for much past those two hours, or for taking a charge that will offer you more than your usual two hours of operation.

So, what you want to do with Ni-Cd's to keep them happy, healthy, and functioning as well as possible, is to occasionally leave your handheld on all day or all night. However long it takes for them to go completely dead. Then give them a full charge. You don't need to do this every day or every week, just every couple of weeks on a radio that gets used regularly should be sufficient.

Maybe others have had different experiences with Ni-Cd's, but this has worked well for me.

### Where Are They?

REACT has put out a 141-page listing of its almost 700 teams now active in the USA, Canada, the UK, and elsewhere. It's called the *Team Contact Directory*, and is a pocket-sized guide listing the mailing addresses, as

well as radio capabilities of the teams in addition to CB. There are also full instructions to getting your emergency call through effectively on CB Channel 9 to the REACT monitor.

The publication is \$4 (US funds) from REACT Directory, P.O. Box 998, Wichita, KS 67201.

By the way, scanner owners please note that, in addition to CB Channel 9, many REACT teams operate communications systems on 462.675 MHz.

### Venerable Veteran

One of the first CB radios to become popular as a high quality set was the Model 242 Viking Messenger from the E.F. Johnson Co., of Waseca, Minn. These radios date back to 1960 or 1961, and were made for several years.

The basic "Johnny Messenger" (as they were nicknamed) was a 5-channel crystal-controlled unit with a 6 tube transmitter and a 4 tube receiver. The receiver had 1 r.f. stage, 1 i.f. stage, plus AVC and a noise limiter. The transmitter used a type 7061 tube in the final. The whole thing was housed in a rugged and attractive silvered metal case. The speaker was in the front panel. There were red and green "transmit" lights, on the front panel, too.

This radio came in three versions. The Model 242-126 was the standard 115 VAC type and sold for \$139.45 (later \$134.95); the Model 242-127 operated from 115 VAC/6VDC (\$144.95); the Model 242-128 was the 115 VAC/12 VDC unit (\$144.95).

A 37-tone selective calling option eventually was offered as an accessory for \$59.95. When in use, the speakers in all units in a radio system were kept muted, regardless of

the activity of other stations on the channel. When one station in this tone call network called another in the network, an audio tone was heard, an indicator light came on, and sound was heard in the speaker. The choice of 37 tones meant that as many as 37 different networks could use these devices locally on the same channel without interfering with one another.

These radios rolled up an excellent reputation. Although designed more for industrial than for hobby use, everybody appreciated them. They were very popular because they could take a lot of rough use. One especially endearing factor was that by simply cutting a single wire in their Messengers, CB'ers could substantially increase the transmitter power of these units.

E. F. Johnson had some great ideas when they were active in the CB field. They had a transistorized 100 mw. handheld around 1961, and by 1967 had put the first large production CB SSB transceiver on the market. There were many Johnson products on the CB shelves throughout the 1960's and 1970's, and they are fondly remembered by all who used them. The company remains in business.

### What Price Glory?

A gentleman from Williamsport, Penna. writes that he has a pair of Vocaline JRC-400 Class B CB transceivers, complete with all power cables and accessories. They are packed in their original cartons, and are like new. In addition, he has a Class B CB ground plane for a base station, Model GP-4. All of this equipment was manufactured by the Vocaline Co. of America, Old Saybrook Conn. He has had many offers to sell these radios, but he has no idea as to its value. He wonders



Here's a photo of Eddy Methot, SSB Network member SSB-77D, of Dalhousie, New Brunswick, Canada. Eddy tells us his favorite book is "Tomcat's Big CB Handbook." Eddy has been a CB'er for more than ten years.



This is the CB shack of Kyle Alsteen, Unit 678, from Dyckesville, Wisc. He monitors the lower side of 39.

if we can place a price on them, or point him in a direction where someone else might.

For those who don't know what Class B CB was, it was opened by the FCC around 1950. The service was established on 465.00 MHz with units permitted to use only very low power. A few companies tried to market equipment for this service, most notably Vocaline and Stewart-Warner. The Vocaline units were boxes made for base and mobile use. The S-W units were bulky and awkward handsets with metal horizontal dipoles on top. Units sold for about \$100 a pair, which was a good week's pay for many people in 1950. But the transmitters were weak, unstable, and temperamental. The regenerative receivers had bad ears. Everything affected the signals, from trees to buildings. Mostly, a decent sneeze could be heard further than a person could communicate with a pair of Class B CB radios. The public ignored Class B CB. The whole thing was a big flop and eventually canceled by the FCC.

Equipment for the old Class B CB is therefore rare. It could be worth a lot to a serious collector, especially if a pair of the units is available in virtually new condition. I would be hard pressed to set a dollar value on these

myself, since I don't personally collect the stuff. This type of information lies within the realm of our friends at Antique Radio Classified (ARC) magazine.

Our column receives a considerable amount of mail regarding the value of older radios, asking where to buy or sell them. That's why we'd certainly suggest pursuing these matters with ARC, as this is their specialty and they are the mavens. Their address is P.O. Box 802, Carlisle, MA 01741. Please mention that POP'COMM sent you.

### A Question

Eddy Methot, SSB-77D, of Dalhousie, New Brunswick, wrote to say that he has avidly collected old *S9 Magazines*. This was a monthly CB magazine edited by Tom Kneitel from 1962 to 1982. In a 1968 issue, Eddy reports that Tom wrote that his frequently-mentioned assistant, Lilia, was leaving to become a mother, and that he would miss drinking her badly brewed coffee. Eddy wonders what ever became of Lilia, and if Tom has ever had any contact with her since then.

We asked Tom, Eddy, and he notes that Lilia's daughter is now 24 years old, which is six years older than Lilia was when she went

to work for *S9 Magazine*. Tom says his remark about the bad coffee was only a joke because Lilia was from Colombia. When she was hired, Lilia could speak only a few words of English. Tom tells us that he has remained in casual contact with Lilia and her husband over the years.

Before we go, we wanted to mention (in case you hadn't yet heard over the air) that the FCC is presently pursuing illegal operators using the unauthorized frequencies between 27.410 and 27.995 MHz. This happens from time to time, and lots of fines are issued. Our advice has always been not to tempt fate by operating there, but, ultimately individuals must be guided by their own sense of what's right for them. Many who enjoy using these otherwise dead frequencies tell us that no harm is caused to anybody by their unauthorized operations there. They suggest that after 30 years of failing to kick the hobbyists off these frequencies, it's now time for the FCC to hang it up and finally authorize these communications. Have you got an opinion? Let us know.

For now, we will be on our way. Let's hear from you with your shack photos, CB QSL's, questions, news clippings, and comments.

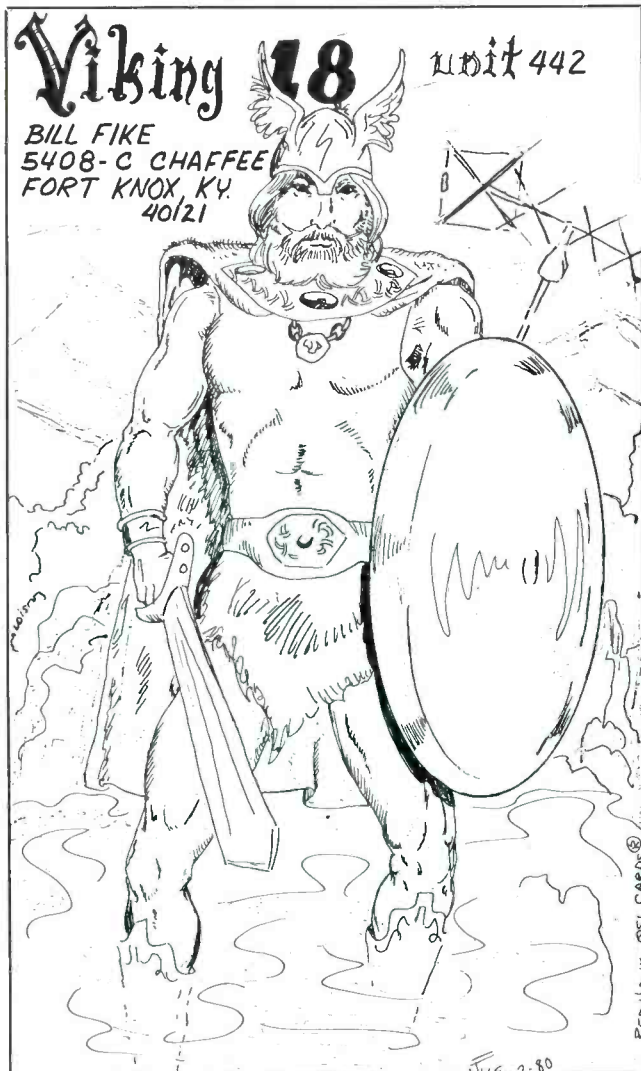

A good looking Viking 18 (and Unit 442) QSL arrived from Bill Fike, Fort Knox, Kentucky.

The *CB Radio Hacker's Guide* has rapidly become a bestseller, offering invaluable peaking and modification information for more than 200 different CB radios.

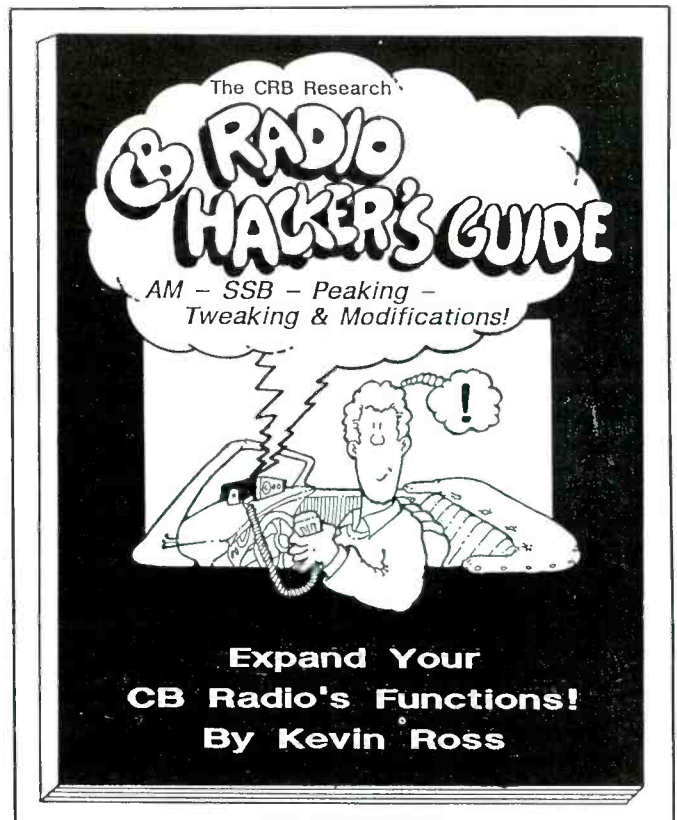

# HOW I GOT STARTED

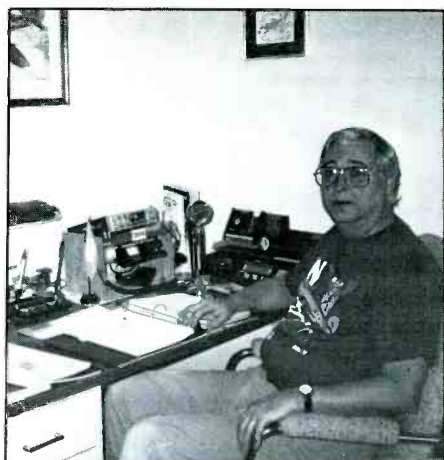

Here's Mr. Lowe at his well laid-out station in Brantford, Ontario.

**W**e invite our readers to submit, in approximately 150 words, how they got started in the communications hobby. Please send them typewritten or otherwise easily readable. If you have a photo of yourself, please include it with your story. We can't return or acknowledge material, whether or not it is used. Your story need be submitted only once, we'll keep it on file to consider it for future issues. All submissions become the property of *Popular Communications*.

Entries will be considered on the basis of their story being especially interesting, unusual, or even amusing. We reserve the right to make any editorial changes we deem neces-

sary to improve style or grammar.

Each month, we will select one winner. The author will receive a 1-year gift subscription (or subscription extension if already a subscriber) to *Popular Communications*.

Address all entries to How I Got Started, Popular Communications, 76 North Broadway, Hicksville, NY 11801.

## Our Winner For November

This month's winner is R. Lowe, of Brantford, Ontario, Canada. Mr. Lowe writes: "Having started in late 1989, I'm a relative newcomer to the hobby. I received a Realistic PRO-2004 as a Christmas gift. At about the same time, a friend of mine introduced me to the world of CB. I was quickly involved in both hobbies.

"The CB unit has given me hours of pleasure. I run an AM/SSB base station with my antenna atop a 40-ft. tower, so I get out quite well. SWL'ing is done with a DX-380. My scanner is programmed for flights in and out of Pearson International Airport in Toronto, the nearby airport in Hamilton, as well as area public safety activities.

"My plans for the immediate future are to get started in ham radio. When I retire, I plan on devoting even more time to these very interesting and rewarding areas of the communications hobby."

Mr. Lowe told *POP'COMM* that he would very much like to correspond (in English only) with other readers wishing to exchange thoughts about the hobby. His address is: R. Lowe, Box 100, Brantford, Ont., Canada N3T 5M3. ■

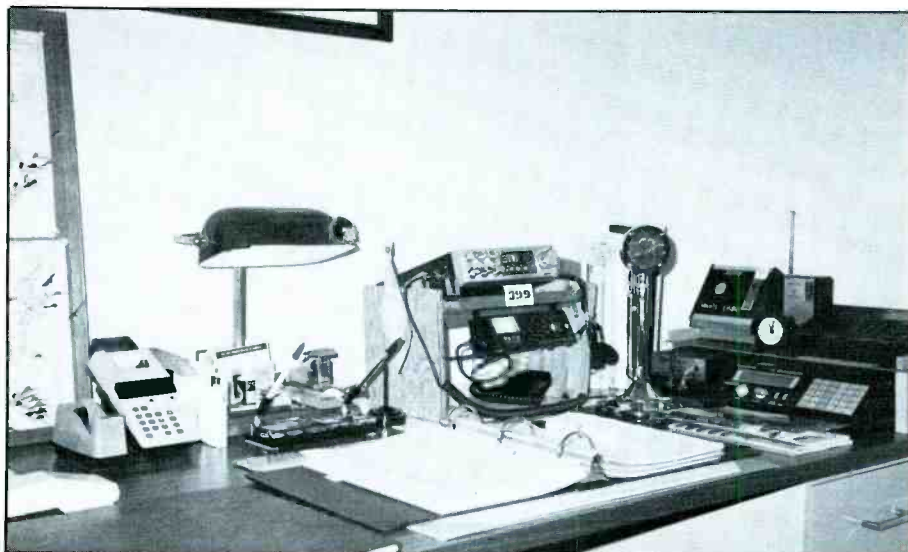

A closer look at the Lowe station, which includes SWL, CB, and scanning equipment.



## The professional weather station comes home.

Thanks to the Weather Wizard II, now you can have a fully sophisticated weather monitoring system right in your own home. Weather Wizard II has all it takes to watch the weather like the pros. All for only \$250.

### FEATURES INCLUDE:

- Inside & Outside Temps
- Wind Speed & Direction
- Wind Chill
- Time & Date
- Alarms
- Highs & Lows
- Instant Metric Conversions
- Rainfall Option
- Optional PC Interface



## WEATHER WIZARD II

THE PROFESSIONAL HOME WEATHER STATION

Only \$250. Add \$50 for self-emptying rain collector. Order today: 1-800-678-3669 • key code CM623H  
M - 7 a.m. to 5:30 p.m. Pacific Time • FAX 1-510-670-0589  
MC and VISA • Add \$5 for shipping. CA residents add sales tax.  
One-year warranty • 30-day money-back guarantee

DAVIS INSTRUMENTS 3465 DIABLO AVE., HAYWARD, CA 94545

CIRCLE 146 ON READER SERVICE CARD

## 10 HOUR RECORDER



- *excellent* audio quality
- trouble-free metal (NOT plastic) chassis
- 5 hours per side, C120 tape
- volume AND tone controls
- AC/DC operation
- digital counter
- BUILT-IN voice activation (no external box) - add \$25\*
- Automatic telephone adapter starts/stops recorder \$16

**\$107\***

### Dialed Number Decoder

- plugs into recorder
- reads out Touch-Tone® numbers from tape

**\$59\***

(Touch-Tone is a trademark of AT&T)

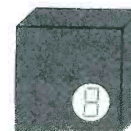

\* special prices for PopComm readers

NO shipping charges on prepaid orders.  
COD's OK. California residents add tax.

**40 Page Catalog \$2 (Refundable)**



**VIKING INTERNATIONAL**

SINCE 1971

150 EXECUTIVE PARK BLVD. #4600  
SAN FRANCISCO, CA 94134

PHONE: (415) 468-2066

FAX: (415) 468-2067

CIRCLE 145 ON READER SERVICE CARD

### News & Notes

**T**he first items on this month's agenda are the winners of the July photo contest. Rev. Dennis Myhand of Dermott, Arkansas found the TVRO dish in the first photo. It is located on the side of one of the Smokey Mountains in Tennessee near the state park. You should have received your satellite photo and poster by now, Dennis.

Mr. William K. Smith, (KA3MFN/4) of Burkeville, Virginia was the winner for the second photo which I must admit took a great deal of time to analyze. Your poster and photo are on the way. I want to congratulate both of our winners and thank all of you who took the time to enter our contest.

I received an interesting letter from Mr. Douglas H. Stingley of Salem, OR. After reading the Jan. '92 issue of SV, Douglas noticed that the Ultra-light aircraft Microwave technology that was discussed was being put into operation in Alaska, originally named Co-OPS by NASA. This space-age method of providing both a remote communications platform and an ingenious method of remote power distribution can be examined in detail in the Sept. '87 issue.

The Alaska State Energy Authority is planning to use this method of electrical power distribution in an experiment to move energy from a distribution plant in Bradley Lake to the city of Dolina in the Kachemak Bay area, according to an article in the Alaska Weekly News.

The ultra light aircraft can stay aloft for months and can be powered by microwave. It carries a rectenna on its underside which converts microwave energy into power to operate the onboard systems. In addition, Microwave power can be reflected to a waiting station on the ground which is precisely what the state of Alaska intends to do. These same platforms can carry all manner of communications equipment. It can be used for utilities and public safety (fire, police, etc.) regional broadcasting or tactical military operations. As Doug points out, the dreams of Nicola Tesla are alive and well in the 49th state.

As Doug is relocating to the Pacific area he is interested in what satellites are available in the area, TV Satellites, that is.

AUSSAT has three I know of, Doug. A TV sat is located at 156, 160 and 164 °W. These are Ku-band satellites. The sats use B-MAC format so you will need an international TVRO receiver capable of decoding several formats. Also be aware that some of the footprints of the satellite signal are rather narrow and aimed at Australia. If you are going to New Guinea you should still be able to pick-up some of ASSAT's signals. These birds even carry re-broadcasts of national radio programs on an-

alog SCPC. Both commercial and governmental TV programming is carried.

Speaking of SCPC, Universal Electronics has announced the introduction of a new SCPC receiver. Known as the Universal SCPC-100. The unit has a 50 channel memory and is compatible with all 950-1450 MHz block systems. It has a large LED readout and works on C and KU band systems without disabling the video of the satellite receiver.

Getting back to Oceania Satellites for a moment. I should mention that there is a TDRS located at 171 °W which relays shuttle and other exotic space signals. Intelsat also has several communications satellites in the area. There are also several C-band satellites in the neighborhood from Russia, China, Japan, India and others. Good luck with TVRO Oceania style, Doug, and thanks for writing.

Alvah Haggert of New York and Wilbur Coffin of Oregon wrote to say they were having trouble tuning in the FDM Weather maps on Spacenet 3 TR #19 HF freq of 1.928.5 kHz, 1.883.8 kHz and 1.568.7 kHz.

While I don't know exactly why you are not able to tune these signals (they may have moved to another satellite which is always a possibility), remember you need a FDM receiver like the Universal M-7000 or a similar unit. Don't forget your through-tap. It blocks any DC voltage on the signal line and protects your equipment while allowing the signal through. You will want to tap onto the base-

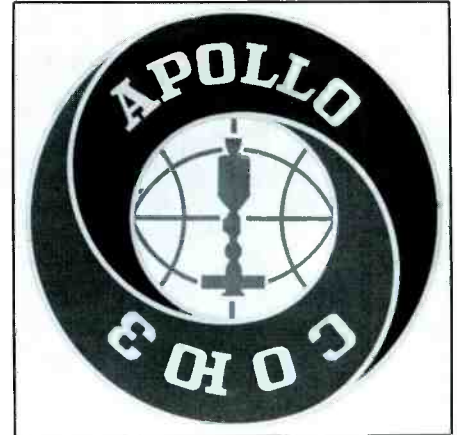

APOLLO/SOYUZ—the only joint US-USSR mission took place in 1975.

band output. I will look into it and inform you of any new information concerning this service. Thanks for keeping me informed.

David Uribe of Brooklyn, New York writes to ask for assistance. He is moving to South America and wants some plans for building a 20 to 30 foot dish. While I have no plans for such a project in my file, I will ask our readers to keep an eye open for such plans. If you are going far enough south you might need such a large antenna. I would ask anyone with plans for a Super-dish to send them to me and I will forward them to Dave.

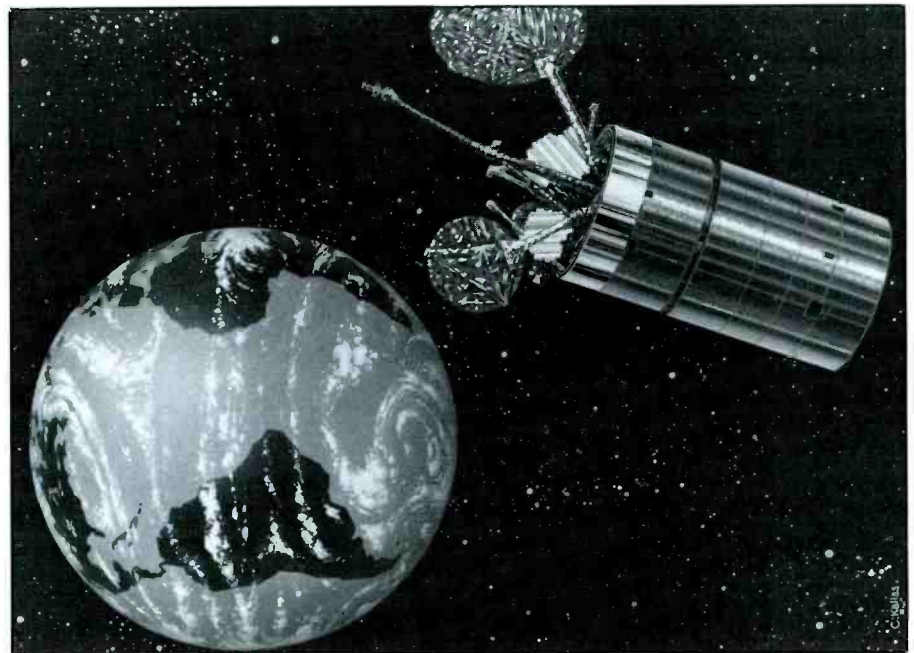

INTELSAT VI can relay 3 TV channels and 120,000 telephone calls.





Here is Universal Electronic's SCPC-100 satellite audio receiver.

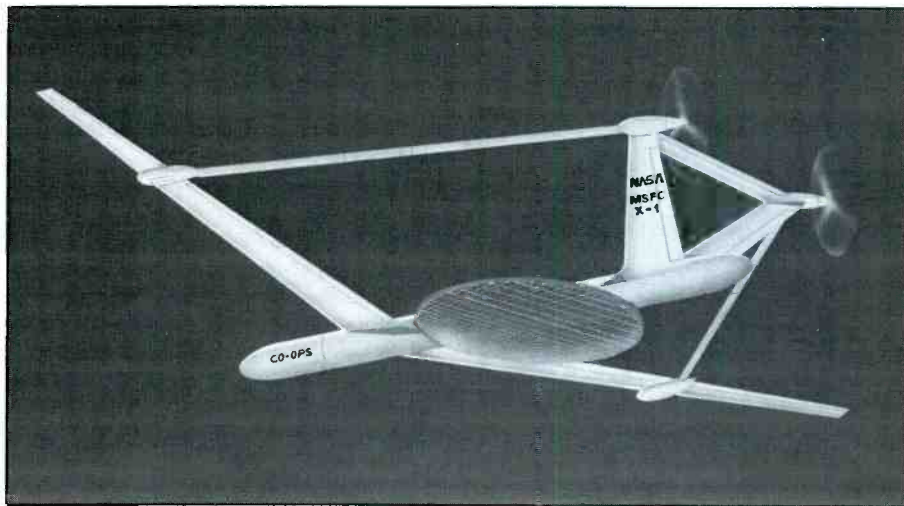

NASA's ultra-light communications platform. (Courtesy NASA)

Are you interested in satellite awards and certificates? In a recent issue of Andy MacAllister's (WA5ZIB) satellite newsletter *OSCAR NOTES*, Heather MacAllister (WB5RMA) wrote an excellent article on what awards are available to the Amateur satellite operator. As with most awards programs they are aimed at the Radio Amateur. Many, however, are available in the SWL version. If you are interested in any of the following awards be sure to write the sponsors and ask about SWL participation. With enough interest *Satellite View* will sponsor a SWL satellite award program.

AMSAT sponsors several awards. The Satellite Communicator's Club certificate is yours for a single verified two-way radio contact. The OSCAR Sexagesimal Award will give you something to work on. It has a certificate with attached stickers for contact increments of 20, 60 and 100 stations.

The ARRL sponsors a Satellite DXCC (DX Century Club) for 100 QSO's and the Satellite DX Achievement Award for 1,000. These are for the serious satellite sleuths. You will find a variety of sponsors for satellite certificates. Lockheed's radio club, the Northern Alberta UHF Society, CQ Magazine and even the Soviet Federation of Radiosport offer awards. You can reach AMSAT at PO Box 27, Washington, DC 20044. You can write CQ (our sister publication) at 76 North Broadway, Hicksville, NY 11801. For more information on Contests/Awards or Oscar Notes, write Andy MacAllister, (WA5ZIB), 14714 Knightsway, Houston, TX 77083.



# SG-230 SMARTUNER

HF ANTENNA COUPLER  
SSB, AM, CW & DATA  
FAST-INTELLIGENT-ACCURATE  
OPERATES WITH ANY HF TRANSCEIVER

The *Smartuner* high technology coupler intelligently tunes any length antenna (8 to 80 ft) in the HF band. The unit will operate with any HF transceiver within its' specifications. The *Smartuner* switches 64 input and 32 output capacitance combinations plus 256 inductance combinations in a "pi" network resulting in over a half-million different ways to ensure a perfect match for the transceiver. And, it remembers the frequency and the tuning values and will re-select these values in less than 10 ms next time you transmit on that frequency.



**PERFORMANCE INFORMATION**

LENGTH OF TIME TO INITIAL TUNING: 5ms (200000 cycles)

HAS SATISFACTORY TEST CALL NUMBER: YES

DISTANCE COMMUNICATED: 1000/1000/1000

INSTALLATION: [ ] LOCAL [ ] REMOTE

TEST CALL: [ ] YES [ ] NO

VOICE QUALITY: [ ] EXCEL [ ] GOOD [ ] POOR

YOUR COMMENTS: [ ]



**SPECIAL HAM PRICE:**  
**\$555.00**

- MICROPROCESSOR CONTROLLED
- NON-VOLATILE MEMORY
- WATERPROOF
- B.I.T.E. INDICATOR

- 1.8 TO 30 MHZ RANGE
- 10 TO 150 WATTS INPUT POWER
- 10 mS RETUNING TIME
- 8 TO 80 FT. ANTENNA (All Types)

• FOR MARINE, AVIATION, HAM AND PARA-MILITARY APPLICATIONS

The SG-230 Smartuner is available from:

Eli's Amateur Radio, FL - 305-525-0103  
Gordon West Radio, CA - 714-549-5000  
Amateur Electronic Supply, WI - 800-558-0411

Henry Radio, CA - 213-820-1234  
Surplus Sales, NE - 402-346-4750  
Ham Radio Outlet, CA - 800-854-6646

Jon's Electronics, CA - 213-390-8003

SGC Inc. SGC Building, 13737 S.E. 26th St. Bellevue, WA 98005 USA  
P.O. Box 3526, 98009. Telex: 328834. Fax: 206-746-6384 Tel: (206) 746-6310

# RANGER SDM-1000

BASE MICROPHONE WITH  
UP/DOWN SCANNING

High-Fidelity Wide band frequency response give your station that broadcast studio sound!

- Electret element and high quality SMT-amplifier
- Modern slim line design – easy to use with minimum space requirement
- Designed for use with all amateur transceivers: HF-VHF-UHF-SHF
- Factory pre-wired for most popular transceivers
- Up-down buttons – locking type PTT switch
- Stable, heavy-duty, die-cast base
- Long-life watch type battery



Pre-wired for:  
AR3300-AR3500-YAESU 8 pin transceivers  
Model F AR3300-AR3500-YAESU 8 pin transceivers  
Model H HR-2510/LINCOLN  
Model I RCI 2900/2950



**CLEAR CHANNEL  
CORPORATION**

PO Box 445  
Issaquah, WA 98027  
**206-222-4295 FAX 206-222-4294**

## WHAT'S HAPPENING WITH CELLULAR, MARINE & MOBILE PHONES

**D**.N.C., a reader in Norfolk, Virginia, wrote to us with some concern about the cellular system tower that was erected only 55 ft. from his home. He tells us that this tower is 125 ft. in height, being a tapered steel pole about 5 ft. in diameter at the bottom. Although only a mile from a major international airport, this structure is completely unlit at night.

Our correspondent writes that because there are low flying helicopters in the area, he doesn't feel safe with this structure so close to his home. He certainly would feel at least a little more comfortable if it was equipped with warning lights, but the cellular company that owns the tower told him that neither the city nor the FAA require that the tower be lit. He asks for our opinion.

Chances are that the cellular company has checked the regulations and is allowed to maintain the tower without warning lights. Tower lighting and marking requirements are both strict and complicated, relating to the height of the structure and its proximity to an airport. FCC regulations Part 17 relate entirely to these matters. Towers are expensive to erect and maintain. A mishap caused by an unlit tower that should have been lit would bring about such a huge negligence suit that it wouldn't pay for a tower owner to skimp on the relatively small cost of properly lighting the structure. Besides, pilots using the nearby airport would begin complaining as soon as the unlit flight hazard was put in their way.

Still, if a person wanted to be certain that a particular tower (cellular, land mobile, or broadcast) met all necessary requirements, they are certainly free to bring their doubts to the attention of the city's Building Inspector, plus the nearest FCC office, as well as the closest FAA office. Ask them to confirm that the particular tower is known to conform to their agency's construction, painting, and lighting regulations. Towers such as this show up on all sorts of records, beginning with permits to build them. Before anything gets built, every plan, and all construction stages, must be approved by a swarming army of rubber stamp weilding local and federal bureaucrats, each determined to cover his own butt.

We suspect that there'd be little chance of sneaking through anything as humongous as an improperly lit tower near an airport. But you never know.

### Air/Ground Developments

Airline passengers on more than 1700 aircraft flown by eleven American based air carriers (as well as Air Canada) can now hear the latest sports, news, weather, and financial updates at their convenience. This comes via the facilities of GTE Airfone.



*Cobra's got a winner in this 900 MHz secure cordless phone featuring spread spectrum and digital technologies.*

GTE Airfone offers short informational broadcasts in four categories: national and world news; sports reports, financial information; and regional weather reports. To access this information, passengers activate the service with a billing card (such as a commercial credit card or telephone calling card), then dial up a speed number. Then the report begins. For weather information, specific regional forecasts may be user selected. Each call is charged at a rate of \$3, which appears on the credit card billing.

The customized audiotex for these services is provided by Brite Systems, Inc., of Wichita, Kansas.

You don't read very much about the original air/ground telephone band, but it's still very active. Ground stations operate in the 454.70 to 454.975 MHz band (25 kHz spaced channels), with the paired aircraft frequencies exactly 5 MHz higher (on 459 MHz). While airlines don't bother with this band, you hear private and corporate aircraft here, including those belonging to celebrities. Regular FM mode is used.

In this service 454.675 MHz (and 459.675 MHz) are used for signaling and alerting tones only. Although you may not be within range of any ground stations, you certainly will get lucky if you search/scan 459.70 to 459.975 MHz, which are the aircraft working frequencies. You can pick up aircraft signals from quite far away. A good route to go is by programming 459.675 MHz, the common downlink signaling channel, into your scan-

ner. When you hear a signal there, you know an aircraft is attempting to place a call. Then, immediately switch over to search/scan all the 459 MHz working channels to locate the aircraft working frequency.

What reminded us of this is that the FCC recently allowed a ground station in this band to be established on 454.85 MHz at Schaller, Iowa. Most of the aircraft using this facility will be either based at Storm Lake Municipal Airport, or else flying between Sioux City and Fort Dodge. Inasmuch as there have been all too few new allocations in this band of late, we thought it a good time to bring these frequencies to your attention, just in case you had forgotten about them.

### Paging Stuff

San Diego's National Dispatch Center, Inc. (NDC) has been chosen by SkyTel to provide operator dispatch paging messages throughout the USA for SkyTel's SkyWord alphanumeric paging system. NDC will provide live operator paging services for all nationwide and regional alpha customers.

To send a message to any SkyTel alphanumeric customer, callers dial 1-(800)-SKYGRAM from anywhere in the USA or Canada. Callers are asked by a digitized voice prompt for the pager ID number of the person being paged. The caller enters the appropriate seven digits via the phone's keypad and is then connected to an NDC operator. There are many sophisticated features and services available to SkyTel's 156,000 subscribers.

SkyTel is the country's largest nationwide paging company. SkyTel pagers work across the USA, Canada, and Mexico, and can receive either numeric or complete text messages on a single frequency. The company is based in Washington, D.C.

NDC, in addition to SkyTel, provides service to over 400 paging companies in the USA.

The State of California asked the FCC to reconsider its ruling that the FCC should be the only regulatory agency controlling nationwide and multi-state wide-area radiopaging proposed by Mobile Telecommunications Corp. (MTel) on 931.4375 MHz. California's position was that it wanted to have a hand in establishing regulations for radiopaging messages sent out on that frequency that were intrastate in nature. The FCC's regulations don't show any distinction between intrastate and interstate operations.

The FCC had previously ruled in this matter that the operations on this frequency were intended to integrate and function within a nationwide system. Therefore they were not primarily intrastate in nature, and they weren't within the regulatory jurisdiction of a state agency. In their denial of the Califor-

nia request for reconsideration, the FCC stood by their earlier positions, adding that MTeI's paging system cannot distinguish between interstate and intrastate messages, anyway.

It was, nevertheless, a very interesting point that California brought up. It will certainly be something we will hear about again as intrastate paging companies begin to complain about having to endure all kinds of state regulations, while their subscribers sign on with nationwide paging companies in order to easily bypass any irritating state restrictions.

## Cellular Stuff

MCI Telecommunications asked the FCC to require all cellular licensees to interconnect with all interexchange carriers (IXC's) via uniform, nationwide, cellular equal access policies and procedures. IXC's provide interstate long distance services.

MCI pointed out that wireline customers in the USA are given the opportunity to select a preferred IXC, and that Bell Operating Companies (BOC's) afford the same opportunities to customers of their services. But MCI claims that non-BOC cellular licensees don't afford customers the chance to presubscribe to a preferred IXC. They hope the FCC will change this in order to even things out.

## New Band, New Cordless

The first 900 MHz extended-range cordless phone from Cobra Electronics is the first to feature digital spread-spectrum technology, offering the dual benefits of advanced speech scrambling for communications security and freedom from interference. The Cobra *Intenna 900* Model CP-910 unit converts analog voice information to digital codes. The secure, all-digital signals are then transmitted in a random pattern that's spread across the full 5 MHz spectrum corresponding to each of the phone's 100 operating channels, as selected by the user.

The handset has a concealed antenna hidden within, so there's no telescopic whip to extend. The CP-910 also incorporates a compander noise-suppression system to achieve best sound quality. Other features include backlit dialpad; two one-touch direct-access memories; intercom; electronic hold; battery saver circuit; out-of-range alert; and auto standby/auto answer to place and receive calls without pressing a "talk button." The handset can be recharged in a vertical or horizontal position.

We always like Cobra's innovative ideas, as well as their products. This looks like another winner.

The MSRP of the CP-910 is \$349.95. For more information, contact Cobra Electronics Group/Dynascan Corp., 6500 West Cortland St., Chicago, IL 60635, or circle 106 on our Readers' Service.

## Mini Cellular

Panasonic has a good looking mini-portable that combines a slim profile with a

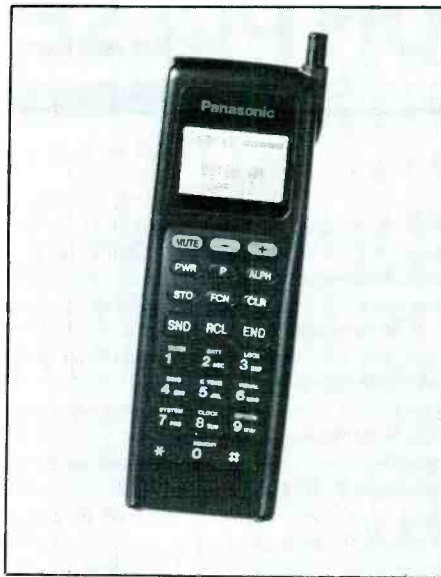

We like this new little Panasonic HH-900 cellular.

lot of versatility. It's called the HH-900.

Turned on its side, the HH-900 is no thicker than a deck of cards. They tell me this phone is environmentally responsible, too. That's because it uses a new nickel metal hydride battery that doesn't contain heavy metals like zinc or lead. There's an optional nickel cadmium battery for people who don't give a damn.

With the ecology battery, the set weighs only 8.2 oz., but when fitted out with the Ni-Cd battery, the weight goes up to 9.5 oz. See what they mean by "heavy metal"? There's a big LCD screen, 200 alphanumeric memories, signal strength indicator, battery level indicator, wake-up display, and last ten number memory, memory map, word list, auto recall, automatic power on/off, and other useful features. The HH-900 provides 80 minutes of continuous talk time and 12 hours of standby. Extended battery operation lengthens this to 150 minutes of talking, 24 hours of standby.

This unit comes in five different customizing kits for particular applications. There's also an in-trunk mobile booster that brings it up to 3 watts of power—just like the 100 watt one you have on your CB radio!

This looks like a nice little set they have come up with. For more information, contact Panasonic Communications & Systems Co., Two Panasonic Way, Secaucus, NJ 07094.

With the holidays on tap, you can start thinking about how either of those two items would look sitting under the tree. Start hinting within the next week or two.

In the mean time, we are out of here for now. Pass along any questions, comments, newspaper clippings, and other items relating to cellular, air/ground, cordless, pagers, ship/shore, and other personal comms systems. We also like product information and also information from service suppliers. ■

## The HB-232

### SCANNER/COMPUTER INTERFACE

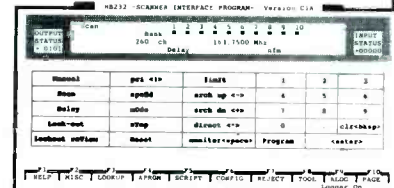

### REVOLUTIONIZES THE ART, SCIENCE & PLEASURE OF SCANNING!

The HB-232 is the long awaited RS-232 scanner controller and data acquisition system brought to you by Bill Cheek, author of the *Scanner Modification Handbooks*.

The HB-232 Scanner/Computer Interface Kit+ includes:

- printed circuit board and essential electronic parts
- Control Program on Disk (specify disk size)
- detailed documentation & photos on assembly, installation & operation
- wide area network technical support

+ Requires PC/XT/AT/clone w/MS-DOS 3.1 or higher & 512-K RAM min; HD recommended.

Designed for the PRO-2004/5/6 scanner series, the HB-232 features AutoLog, AutoProgram, Data LookUp, Scripts & much more with nearly unlimited variations of computer control & data collection from the scanner. Facilitates maximum performance without compromise. Easy to install & use, minimal invasion to scanner! Discover a new dimension of radio scanning! Order today! \$169.95 + \$5 S&H, ck mo, M/C/VISA.

BASE for more info.

**COMMtronics Engineering**

P.O. Box 262478-P

San Diego, CA 92196-2478

(619) 578-9247

1:30pm-5:30pm, PST: Voice Only

6:00pm-1:00pm, PST: BBS & FAX Only

CIRCLE 119 ON READER SERVICE CARD

**SATELLITE TV BUYING GUIDE**

CALL FOR

**SATELLITE TV**

**NAME BRANDS AT 50% DISCOUNT**

This FREE 24 page Consumer Buying Guide tells all about Satellite TV and lists guaranteed lowest prices.

Salman, Inc.

6310 N University No 3798 • Peoria, IL 61612

**1-800-472-8626**

**PROSCAN**

**EZ TO USE FREQUENCY MANAGER**

ProScan takes the chore out of tracking frequencies. TRACK up to 9999 frequencies by bank, channel, name, location, class, type, call sign. Records listed **ONSCREEN** in order by channel, frequency, name, location or class. Changing orders is as easy as pressing the left or right arrow keys. ProScan **INSTANTLY** seeks records by channel, frequency, name, Intelligent Seek provides closest match when exact match is not found. Each frequency record has **GENEROUS NOTEPAD** w/ auto time-date stamp and frequency duplication validation. ProScan not only prints records by channel, frequency, name, location or class it prints selected groups as well. Requires DOS/640k/hardisk. **ONLY \$39.95** includes manual. \$34.95 for disk only. \$12.50 for manual & demo disk. Specify disk size. Send Check/MO. DataFile Inc. PO Box 20111 St. Louis MO 63123

CIRCLE 147 ON READER SERVICE CARD

**SHOCKING MANUALS!!**

Survival Electronics, Computers, Security, Weaponry, Rocketry, Phonics, Energy, Financial, Medical. 100+ offers include Special Projects and Technical Research Services, and hardware. **Confidentiality Guaranteed!** Send \$4 for new Combined Catalog. By John Williams, former Senior Engineer (Lockheed), Professor of Computer Science (NMSU). As seen on CBS "60 Minutes". Since 1971.

**CELLULAR PHONE MANUAL:** Detailed manual on how cellular phones are re-programmed (ESNs and NAMS) and scanned. 30+ cellular phone mode described. Specific scanner mode. \$39.

**VOICE MAIL BOX HACKING:** Step-by-step descriptions of how 8 popular voice mail PBX systems are hacked. \$29.

**BEYOND VAN ECK PHREAKING:** Plans for surveillance systems: some use to eavesdrop on TVs and computer monitors. \$29.

**SECRET & SURVIVAL RADIO:** Detailed manual describes the optimum freqs, equipment, modes and circuits for secret, survival and security situations. Includes small transmitters and receivers; ultrasonic, infrared and fiberoptic comms; improving and optimizing antennas. 70+ circuit diagrams. \$29.

**COMPUTER PHREAKING:** Detailed manual describes both computer viruses and how computers are penetrated. Includes 2 PC disks. (1) FLUSHOUT: protection system. (2) Disk loaded with hacker files. \$39.

Many more: **STEALTH TECHNOLOGY** (\$19), **PHONE COLOR BOXES** (\$25), **TV DECODERS & CONVERTERS** (\$14), **STOPPING POWER METERS** (\$19), **RADIONICS MANUAL** (\$29), **EM BRAINDLASTER** (\$29), **UNDER ATTACK** (\$29), **HIGH VOLTAGE DEVICES** (\$29), **DISK SERVICE MANUAL** (\$29), **ATM** (\$39), include \$4 S/H. Educational purposes only.

**CONSUMERTRONICS**

2011 CRESCENT, P.O. DRAWER 537, ALAMOGORDO, NM 88310

VOICE: (505) 434-0234, 434-1778 (8AM-9PM MST, Mon-Sat)

FAX: 434-0234 (orders only 24-hours, 7 days/week if you get answering machine press "\*" then "1" any time)

CIRCLE 149 ON READER SERVICE CARD

### **Operation of Part 15 Transmitters on GMDSS Bands**

The FCC proposed amending Part 15 of its rules to restrict the operation of low power, non-licensed transmitters on certain frequency bands that were recently authorized for the Global Maritime Distress and Safety System (GMDSS).

The GMDSS is an automated ship-to-shore distress alerting system that is used for worldwide alerting, coordinated search and rescue operations and the dissemination of maritime safety information.

By prohibiting Part 15 transmitters from operating in these bands, and by restricting the limit on spurious emissions within these bands, the potential for harmful interference to the GMDSS is reduced. Harmful interference to the GMDSS could jeopardize critical safety-of-life operations in the Maritime Service.

Therefore, the Commission has proposed amending the rules to expand the list of restricted frequency bands in Part 15 to contain the GMDSS bands.

It also proposed reducing the width of the existing restricted frequency band of 490-510 kHz to 495-505 kHz. This restricted band provides interference protection to the maritime distress frequency 500 kHz. The guardbands for that frequency are scheduled to be reduced when the GMDSS is fully implemented on February 1, 1999.

### **Propose Revision of Rules to Harmonize with International Standards**

The Commission proposed amending Part 15 of its rules to permit the manufacturers of digital devices to demonstrate compliance with either FCC requirements or international standards for radio frequency emissions. The stated objective of the proposal is to ensure that U.S. manufacturers have reasonable opportunities to compete fairly and effectively in the international marketplace.

Part 15 of the Commission's rules governs the operation of radio frequency (RF) devices without an individual license. Digital devices, such as computers, generate and use RF energy. These devices are subject to the provisions contained in Part 15 limiting radio noise emitted by unintentional radiators. Part 15 was recently revised to establish uniform standards for unintentional radiators.

The standards in Part 15 apply only to products used in the United States. Many other countries, most notably the European Community countries, are in the process of requiring digital devices to comply with stand-

ards developed by the International Electrotechnical Commission (IEC). CISPR adopts recommendations for limits and methods of measurement to control radio interference.

The Commission noted that harmonization of its rules for digital devices with the standards developed by CISPR would benefit U.S. producers in an international marketplace. Responding to petitions filed by Computer and Business Equipment Manufacturers Association (CBEMA) and the NCR Corporation, the Commission proposed to allow manufacturers to meet either set of standards for products produced and used in the U.S. The Commission believes such a change would reduce unnecessary design and testing burdens on digital device manufacturers and would, at the same time, serve the Commission's interference control objectives.

### **Propose Relaxing Restrictions on Permissible Communications in Amateur Service**

The FCC proposed amending its rules for the amateur service by lessening restrictions on the scope of the permissible communications that amateur stations may transmit communications for public service projects and personal matters.

The Commission noted that many individuals in the amateur community appear to strongly support relaxing one or more of the existing restrictions on the scope of amateur services communications. The restrictions were designed to protect the non-commercial character of the amateur service and ensure its basis and purpose i.e., as a reservoir of volunteer communicators, technicians and electronics experts dedicated to advancing the radio art, to provide public service communications particularly in times of emergencies, and to enhance international goodwill, could be carried out. While eliminating some of the existing restrictions would provide the flexibility to expand public service activities and satisfy the personal communications interests, the potential for commercial exploitations and abuse of the amateur service's allocated frequencies could increase.

Specifically, the Commission proposed the revision suggested by the American Radio Relay League. This revision would allow amateur stations to transmit occasionally certain types of communications that are now prohibited. The intent of the suggested revision is to allow amateur operators who so desire greater flexibility to increase their public service communications activities, for example, in support of parades, races, and other such public gatherings. The general prohibition against amateur stations transmitting

messages for hire or for material compensation, direct or indirect, however, would remain in the rules.

These proposals are not intended to alter in any way the nature and purpose of the amateur service. The proposed changes, however, would increase the amateur community's responsibilities for self-regulation and cooperation in the use of their allocated frequencies.

### **Physician's Certification for Handicapped Amateurs**

Any amateur operator license applicant seeking code credit because of a severe handicap, the duration of which will extend for more than 365 days beyond the date of the physician's certifications, must use FCC Form 610 dated March 1992. The applicant must complete the patient's release on the 610.

The Commission adopted a Report and Order on December 13, 1990 that exempted from the 13 and 20 words per minute (wpm) telegraphy examinations amateur operator licensees who are incapable of passing those examinations due to severe handicaps. Because of international requirements, however no exemptions will be granted from the 5 wpm telegraphy examination.

Section 97.505(a)(5) of the Commission's Rules, 47 C.F.R. 97.505(a)(5), requires that a physician's certification and a patient's release permitting disclosure to the FCC of medical information pertaining to the handicap be completed. The term "physician" is limited to practitioners with full medical privileges, that is, doctors of osteopathy or doctors of medicine.

For further information contact Consumer Assistance Branch, 717-337-1212.

### **Amateur Radio Services Rules Concerning Space Operation**

The Commission amended the amateur radio services rules to authorize any amateur operator to be the licensee of a space station.

A space station is an amateur station located more than 50 kilometers above the Earth's surface that transmits on frequencies allocated to the amateur-satellite service. Commission rules currently provide that only an Amateur Extra Class operator may be the licensee of a space station. Amateur Extra is the highest grade of the five classes of amateur operator license.

The Commission believes that permitting any amateur station to transmit from space would benefit both the amateur community

and the public. Amateur operators would have greater access to space telecommunication technology and the public would have a more highly-trained pool of operators and electronics experts available in emergencies. Additionally, the Commission would benefit because rule waivers to astronauts who wish to operate their amateur stations in space would not have to be issued.

The Commission declined, however, to define a spacecraft as a "ship." The Commission will continue to follow the definition of space station as contained in the international Radio Regulations. The Commission noted that the volunteer-examiner coordinators can rearrange in their pools the necessary questions concerning proper operation of a space station.

### Inclusion of Novice Examination in Volunteer-Examiner Coordinator System Proposed

The FCC proposed amending the amateur service rules to include the responsibility for the preparation and administration of Novice Class operator license examinations under the volunteer-examiner coordinator (VEC) system. This change would simplify and standardize the examination process for amateur service examinations.

There is a five-tier operator license structure in the amateur service. The operator classes are, in ascending order, Novice, Technician, General, Advanced and Amateur Extra. All operator license examinations, except for the Novice Class, are administered in the VEC system. In calendar year 1991, the VEC system administered 172,061 examination elements to 103,251 persons at 8,118 sessions.

The VEC system has some 30,000 trained and accredited volunteer examiners (VE's) closely coordinated by 18 VEC's. Each examination for the Novice Class operator license is administered at an ad hoc session by two amateur operators selected by the examinee.

Although a person may enter the amateur service at any of the five classes of operator license, before April 1991 most newcomers elected to enter at the Novice Class. The deletion of the telegraphy examination as a requirement for the Technician Class license examination, however, now makes it the entry level of choice.

The W5YI-VEC and The American Radio Relay League, Inc. (ARRL) recommended that, in the interest of efficiency, Novice examinations be included in the VEC system. The ARRL, in addition to its membership and publishing activities, is also a VEC. It and W5YI-VEC are two of the most active VEC's.

The Commission said the VEC system has turned out to be much more efficient than the ad hoc Novice licensing system. Administering all examinations under the VEC system would simplify the amateur service application form and avoid the confusion that now

exists because of two different systems for amateur service examinations.

### Phase-out of Class C Epirbs Proposed

The Commission proposed amending Part 80 of the rules to phase out the use of Class C Emergency Position Indicating Radio Beacons (EPIRB's) by February 1, 1999. This action is in response to a petition by the U.S. Coast Guard.

EPIRB's are small, battery powered transmitters carried on ships for the purpose of sending a distress signal. The distress signal is used both as an alarm to alert others that a ship is in distress and as a beacon to aid in

its location by search and rescue (SAR) personnel. EPIRB's may be activated automatically or manually. There are two general classes of EPIRB's, those primarily intended to be detected by satellite (satellite EPIRB's) and those intended to be detected by nearby ship or coast stations (Class C EPIRB's).

Satellite EPIRB's are used in conjunction with the COPAS-SARSAT system of polar orbiting satellites that use dedicated receivers to detect distress signals. These signals are then relayed to SAR operations. Class C EPIRB signals cannot be received by the satellite system and are transmitted on channel 16 for alerting purposes and alternatively on channel 15 for location purposes. Because of their low transmitting power, Class C



## World's Most Powerful CB and Amateur Mobile Antenna\*

Lockheed Corp. Test Shows  
**Wilson 1000 CB Antenna Has  
58% More Gain Than The  
K40 Antenna (on channel 40).**

In tests conducted by Lockheed Corporation, one of the world's largest Aerospace Companies, at their Rye Canyon Laboratory and Antenna Test Range, the Wilson 1000 was found to have 58% more power gain than the K40 Electronics Company, K40 CB Antenna. This means that the Wilson 1000 gives you 58% more gain on both transmit and receive. Now you can instantly increase your operating range by using a Wilson 1000.

**Guaranteed To Transmit and Receive  
Farther Than Any Other Mobile  
CB Antenna or Your Money Back\*\*  
New Design**

The Wilson 1000 higher gain performance is a result of new design developments that bring you the most powerful CB base loaded antenna available.

#### Why Wilson 1000 Performs Better

Many CB antennas lose more than 50% of the power put into them. The power is wasted as heat loss in the plastic inside the coil form and not radiated as radio waves.

We have designed a new coil form which suspends the coil in air and still retains the rigidity needed for support. This new design eliminates 95% of the dielectric losses. We feel that this new design is so unique that we have filed a patent application on it.

In addition, we use 10 Ga. silver plated wire to reduce resistive losses to a minimum.

In order to handle higher power for amateur use, we used the more efficient direct coupling method of matching, rather than the lossy capacitor coupling. With this method the Wilson 1000 will handle 3000 watts of power.

#### The Best You Can Buy

So far you have read about why the Wilson 1000 performs better, but it is also one of the most rugged antennas you can buy. It is made from high impact thermoplastics with ultraviolet protection. The threaded body mount and coil threads are stainless steel; the whip is tapered 17-7 ph. stainless steel. All of these reasons are why it is the best CB antenna on the market today, and we guarantee to you that it will outperform any CB antenna (K40, Formula 1, you name it) or your money back!

\*Inductively base loaded antennas  
\*\*Call for details.

#### Lockheed - California Company

A Division of Lockheed Corporation  
Burbank, California 91520

Aug. 21, 1987

Wilson Antenna Company Inc.  
3 Sunset Way Unit A-10  
Green Valley Commerce Center  
Henderson, Nevada 89015

Subject: Comparative Gain Testing of Citizen's Band Antennas  
Ref: Rye Canyon Antenna Lab File #870529

We have completed relative gain measurements of your model 1000 antenna using the K-40 antenna as the reference. The test was conducted with the antennas mounted on a 16' ground plane with a separation of greater than 300' between the transmit and test antennas. The antennas were tuned by the standard VSWR method. The results of the test are tabulated below:

FREQUENCY (MHZ)	RELATIVE GAIN (dB)	RELATIVE POWER GAIN (%)
26.965	1.30	35
27.015	1.30	35
27.065	1.45	40
27.115	1.60	45
27.165	1.50	41
27.215	1.60	45
27.265	1.75	50
27.315	1.95	57
27.365	2.00	58
27.405	2.00	58

**58%  
MORE  
POWER GAIN  
THAN THE  
K40**

**CALL TODAY**  
TOLL FREE: 1-800-541-6116  
FOR YOUR NEAREST DEALER  
**Wilson 1000**  
Available in Black or White

Roof Top Mount ..... 59<sup>95</sup>  
Trunk Lip Mount ..... 69<sup>95</sup>  
Magnetic Mount ..... 79<sup>95</sup>  
Wilson 1000 Trucker ..... 59<sup>95</sup>  
DEALERS Exclusive dealer areas still open

**Wilson**  
ANTENNA INC.  
1181 GRIER DR., STE. A  
LAS VEGAS, NV 89119

**1-800-666-0908**

**New Equipment Orders & Prices Only, Please**

**Shortwave Radios**

SONY® • All Popular Models Including The ICF2010, SW55, And The New SW77  
• Phillips DC777 AM/FM/CASS/Shortwave Car Radio • Sangean • ICOM • JRC  
• Panasonic • Yaesu • And the Superb Drake R8

Grundig Satellit 500  
On Sale! Call For Low, Low Price.



**Scanning Radios**

Featuring AOR Models AR1000XLT and AR3000A • ICOM R1, R100, and R7100 • Uniden Bearcat - All Models

**Amateur Radio Equipment**

Factory Authorized Dealer For:

**ALINCO**  **STANDARD**

**KENWOOD**  **COMET**

**YAESU**   **Cushcraft**

**DIAMOND**  **MFJ** 

Accessories, etc.

• Call For Our Low Discount Prices •  
For info and tech help call (203) 666-6227  
Out-of-State Sales Call 1-800-666-0908  
Conn. Sales Call (203) 667-9479

**LENTINI COMMUNICATIONS, INC.**

21 Garfield St. Newington, CT. 06111

C.O.D.'s OK



SAME DAY SHIPPING



CIRCLE 135 ON READER SERVICE CARD

**YOU AIN'T HEARD NOTHIN'...YET**

Since 1967, CRB Research has been the world's leading publisher and supplier of unique hobby and professional books and information including:

Scanner Frequency Guides  
Shortwave Frequency Guides  
Military/Federal Communications  
& Other Related Topics

**Ask for Big Free Catalog**

**CRB RESEARCH**

**P.O. Box 56, Commack, NY 11725**

CIRCLE 4 ON READER SERVICE CARD

**CABLE TV CONVERTERS**

Save \$100's

- All makes and models
- Quality Equipment
- Shipped within 24 hrs
- Years of customers complete satisfaction
- Free catalog

**L & L ELECTRONICS INC.**

1430 Miner St. Suite 522  
Des Plaines, IL 60016



**1-800-542-9425**



Purchaser must agree to comply with all State and Federal laws.

EPIRB distress signals can only be received by nearby ship and coast stations.

The Coast Guard said that the recently adopted Global Maritime Distress Safety System will eliminate the current mandatory watch of channel 16, and therefore, without the monitoring, the Class C EPIRB's will be ineffective for search and rescue purposes. The Coast Guard plans to discontinue the monitoring requirement in 1999. The Coast Guard currently recommends carriage of satellite EPIRB's in lieu of Class C types.

### **FCC Proposes That Carriers Report Technical Information in Computer Readable Form**

The FCC proposed that common carrier applicants, permittees and licensees under Parts 21, 22, 23 and 25 of its rules report technical information in computer readable form. This would allow the FCC to create an automated database to protect domestic licensees at risk of harmful electrical interference to and from foreign carriers, and to improve the reporting of frequency assignments to the International Frequency Registration Board (IFRB).

The Commission said the establishment of such requirements would mandate the submission of certain technical operating information by U.S. radio station licensees in the Domestic Public Fixed, Public Mobile, Inter-

national Fixed Public, and Satellite Radio Communications Services that operate in geographic areas most likely to require international coordination.

The reporting requirements for frequency coordination contained in International Telecommunication Union (ITU) Radio Regulations and IFRB-prescribed procedures, provide for frequency assignments to be notified and registered in the Master International Frequency Register. As a signatory to the ITU Convention, and the related Radio Regulations, the United States has a responsibility to cooperate with foreign governments in the international management and coordination of spectrum utilization. Recent growth in the use of radio spectrum for domestic, international, terrestrial and satellite communications has generated a greater need to ensure timely, accurate reporting to the IFRB, efficient coordination by the Commission, and improved interference protection for domestic licensees.

Current FCC rules do not require applicants, permittees or licensees to report all the data necessary for these purposes, and the data that the Commission has on hand is not in a format that is readily transferable to a computer database. Such a database would facilitate more efficient and accurate frequency assignment reporting, coordination, and submittal to the IFRB, and thereby provide increased protection for domestic carriers in zones at risk of interference to or from foreign stations.

Comments are requested as to the rules and reporting information proposed for efficient notification of licensed frequencies and other operational parameters of domestic common carriers to the IFRB and for improved coordination with foreign governments.

### **Requirements for 220 MHz Nationwide Licensees**

The Commission modified the financial and reporting requirements applicable to 220 MHz non-commercial nationwide licensees.

This action comes as a result of various petitions for reconsideration of the Commission's 1991 Report and Order which adopted rules governing narrowband land mobile operations in the 220-222 MHz band. The Commission has also resolved the Further Notice of Proposed Rulemaking in this proceeding, which addressed procedures for selection of 220 MHz nationwide licensees. Today's action modifies the 1991 Report and Order to:

- Eliminate the "second audit" requirement to permit applicants relying on internal financing to submit an unaudited certified balance sheet in its place;
- Require that applicants for nationwide non-commercial licensing demonstrate an actual presence or long-term business plan necessitating internal communications capacity in the 70 or more markets identified in the license application;
- Provide that an application to transfer or assign a non-commercial nationwide system

### **INTERFERENCE FILTERS**

Our specialty is eliminating Broadcast Band Interference from your receiver. Antenna & powerline filters stop broadcast energy from reaching your receiver. Call or write for **FREE** information package.

**Northwest Communication Laboratories**  
813 S.W. Highland, Suite C-310  
Redmond, OR 97756 (503) 923-2540

CIRCLE 133 ON READER SERVICE CARD

### **PICKS UP A WHISPER 50 FEET AWAY!**

**NEW! High-power miniature transmitter on a single chip assembles in only 5 minutes!**

Simply attach the **VT-75** microtransmitter to any 3V to 12V battery and you can hear every sound in an entire house over 1 mile away! Super-sensitive circuit on a single chip even picks up footsteps from across a large room. Tunable from 80 to 130 MHz. Hear everything on any FM radio or wideband scanner tuned to the "secret" frequency you select. Unlimited uses for security, baby monitor, remote mic, etc. **Not a toy.** The **VT-75** meets many U.S. Gov't Military Specs and with **100mW RF output**, it is the smallest, most powerful miniature transmitter you can buy. Easily assembled even by a youngster in only 5 minutes and performs so well that it is the only miniature transmitter available **anywhere** that comes with a **full unconditional moneyback guarantee!** Dealers welcome. Law Enforcement inquiries invited. **VT-75** microtransmitter chip with miniature microphone, 9V battery connector and instructions. **\$49.98 + \$1.50 S&H** or save - buy 2 for \$45.00 each with free S&H! Call us toll free or send money order, Visa, or Mastercard for immediate shipping by U.S. Mail. COD's add \$4. Personal checks allow 21 days.

**DECO INDUSTRIES** **BOX 607**  
**BEDFORD HILLS, NY 10507**  
**800-759-5553**

The leader in wireless design since 1976

CIRCLE 134 ON READER SERVICE CARD

will not be permitted during the first ten-year license term;

—Require nationwide non-commercial licensees to construct base stations in a minimum of 70 markets designated in the application within five years of the initial license grant;

—Provide that nationwide non-commercial licensees will not be permitted to lease excess capacity on their systems during the first five years of the license term;

If, in light of any of the rule changes applicable to non-commercial licensees, a nationwide non-commercial applicant wishes to withdraw its application, it will be permitted to do so any time before the lottery is held, and its application fees will be refunded. Applicants for nationwide non-commercial licenses that wish to amend their applications to reflect these changes may do so within 30 days of the effective date of the new rules.

The Commission reaffirmed its previous decisions on the effective date of the rule that applications will be processed on a first-come, first-served basis; the exclusion of wireline telephone companies from eligibility for commercial licensing in the 220-222 MHz band; the use of lottery proceedings rather than comparative hearings to resolve mutually exclusive nationwide applications; certain financial requirements and other entry criteria; and restricting access to those channels set aside for public safety/mutual aid use to Public Safety Radio Service eligibles.

### Two Exemption Categories Created for Small Passenger Vessels

The Commission amended its Maritime Service Rules (Part 80) to establish a general exemption category for certain U.S. passenger vessels of less than 100 gross tons (small passenger vessels) that operate at distances of 100-200 nautical miles and more than 200 nautical miles from the nearest land.

All U.S. passenger vessels navigated in the open sea that carry more than 12 passengers are required to be equipped with a manual Morse code radiotelegraph station. The law permits the Commission to exempt from this provision small passenger vessels not operating on international voyages. The general exemption previously had been limited to ships operating within 100 nautical miles of the nearest land.

The Report and Order in this proceeding added a new exemption category permitting small passenger vessels to operate beyond 100 nautical miles from land, provided they carry specified radio equipment. Although the rule making notice in this proceeding proposed adding two new exemption categories for vessels: one new category for vessels operated 100-200 nautical miles from land, and another for vessels operated 200-500 nautical miles from land, the Commission ultimately adopted the suggestion of commenters that a single exemption be made for all voyages beyond 100 nautical miles, with no

mileage restrictions, provided the vessels are equipped with specific radio equipment.

The Offshore Marine Service Association (OMSA) asked the Commission to reconsider its decision and adopt the equipment requirements and mileage limitations originally proposed.

The Commission said it agreed with OMSA that adequate safety communications capability can be ensured for the mileage category 100-200 nautical miles without requiring all the equipment necessary for vessels operating on extended open ocean routes beyond 200 nautical miles from the nearest land. The Commission noted that the U.S. Coast Guard has regulations for vessels that only operate on voyages up to 200 nautical miles from the nearest land and did not oppose the creation of such a category.

### Propose Amending Rules Regarding Fire Call Box Operation

The FCC proposed amending Part 90 of the Commission's Rules to permit licensees in the Fire Radio Service to conduct fire call box operations on low-power frequencies in the 72-76 MHz band currently assigned to other Part 90 radio services. Under this proposal, those eligible licensees in the Fire Radio Service would utilize, on a shared basis, low-power frequencies allocated to the Forest Products, Special Industrial, Railroad, and Manufacturers Radio Services for fire call box operations.

Fire call boxes are located throughout a local fire authority's operating area to provide a method for fire alarm notification and a means for monitoring vacant buildings and offices. These call boxes transmit on frequencies within the 72-76 MHz band designated for fixed use, but are limited to a transmitter output of one watt pursuant to Section 90.241(a)(1).

These call boxes currently share frequencies with other fixed stations operating at up to 300 watts. The higher-power co-channel licensees cause interference and adversely affect the operation of fire call box systems, thereby imperiling the safety of life and property. This problem inspired the International Association of Fire Chiefs, Inc. and the International Municipal Signal Association to petition the Commission for change. The petitioners noted that there are 10 other shared frequencies in the 72-76 MHz band that could be useful for call box operations. These alternative 10 frequencies, while reserved for low power mobile use, may be operated as either mobile, base, or fixed stations. The problem of sharing frequencies with 300 watt users would then be eliminated. The Petitioners therefore requested and the Commission has agreed to consider use of these frequencies on a coordinated basis with those that have already received allocation. ■

## SE SIGNAL ENGINEERING's High Performance CB Antennas

**SUPERHAWK**  
\$114.95

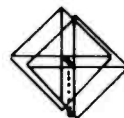

**Goldenrod 45 Mobile Antenna**

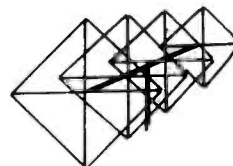

**WHITE LIGHTNING**  
\$199.95

**SPYDER A**  
\$35.95

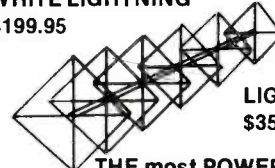

**LIGHTNING 6**  
\$359.95

**THE most POWERFUL CB base in the world today!**

All SE PATENTED rotary beams are true quads and OUTPERFORM their counter parts (quad/yagi types). SE's patented SFS matching system makes SE QUADS the most technologically advanced antennas in the world today.

If your dealer doesn't have SIGNAL ENGINEERING, write or call for full specs. DEALER INQUIRIES INVITED.

## SIGNAL ENGINEERING

2624 Fayette Drive, Mountain View, CA 94040  
(415) 948-3833

### SPY ON THE EARTH

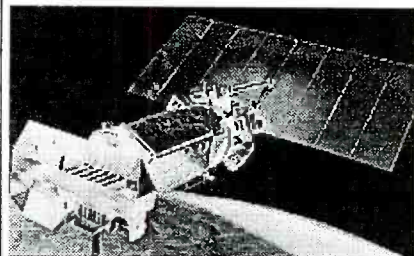

**See live on your PC what satellites in orbit see**

Learn how you can benefit greatly from this exciting new technology. Send \$25 (\$30 air, \$35 overseas) for our *fantastic* 12 diskette set of professional quality copyrighted programs (IBM type) that does satellite tracking, data acquisition, image processing, file conversion and much more. Diskette package includes all programs, satellite views, C language source code for a popular satellite image acquisition program, hardware schematics, catalog and \$25 discount certificate.

**Reception guaranteed Worldwide**  
**Absolutely legal**  
**No satellite dish needed**

For FREE information log on to our bulletin board with your MODEM at (718) 740-3911 or call (718) 468-2720, to place an order. Buy with confidence. We've been in business since 1956.

**VANGUARD Electronic Labs**  
Dept. PC, 196-23 Jamaica Ave.  
Hollis, NY 11423

## THE EXCITING WORLD OF RADIOTELETYPE MONITORING

Argentina's Navy may be using packet radio for RTTY communications, recent monitoring shows. This speculation comes after seeing encrypted traffic between two stations called "Dipacom Salta" and "BSAS."

Communications were held in July on 13921.3 kHz at 0027 UTC (see figure 1). I believe that Salta refers to the city with the same name in Argentina, Dipacom stands for Director Pacific Command, and "BSAS" is Buenos Aires. ITU files list seven call signs for Argentina on the nearby frequency of 13920.5 kHz, but none is for a transmitter in Salta.

For many, many months I've watched a station identifying itself only as "LYNX" with ARQ phasing signals on the 10 and 11 MHz bands along with the call letters in Morse Code. I never saw any messages, and therefore wondered about the legitimacy of the station.

Finally, at 0033 UTC on July 3, a message did appear. It was in English. But, alas, it came during a time of poor propagation and most words were either garbled or lost in the ether. From the little that I saw, mostly after the beginning of some routing directions, marked "RR Ord . . .," it seems that "LYNX" is a military station. No messages were seen for the next several days afterward, but LYNX was still there with its taunting ways.

Two more new call signs were gleaned from recent Inter-American Naval Telecommunications RTTY traffic. Call signs and locations are HRN1, Tegucigalpa Naval Radio, Honduras; and HIWF1, Santo Domingo Naval Radio, Dominican Republic.

One admonition often heard regarding radio communications of all types is to watch what is said on the air, for others may be listening when you don't expect or want them to be. The following true story shows what can go wrong if this advice is not heeded.

There were a couple of guys in the Army who spent more than a half hour sending foul-language messages back and forth, not realizing that other persons and I were on hand to view their electronic graffiti. This occurred at around 1745 UTC on June 25, on 13415.5 kHz, 85°/50N. The stations used the call signs CHA and CHC, which seemed to be legitimate.

About 20 minutes later, someone calling himself "Pronto" broke into their conversation and ordered them to quit "fooling around." One of the two then directed a brief verbal attack on "Pronto" before returning to his XXX-rated chatter. Ten minutes more passed. "Pronto" came back and typed, "CHC this is Pronto. There will be no more fooling around on these means. If there is, your weekend will be lost because it is already at stake now. If you think I am joking there

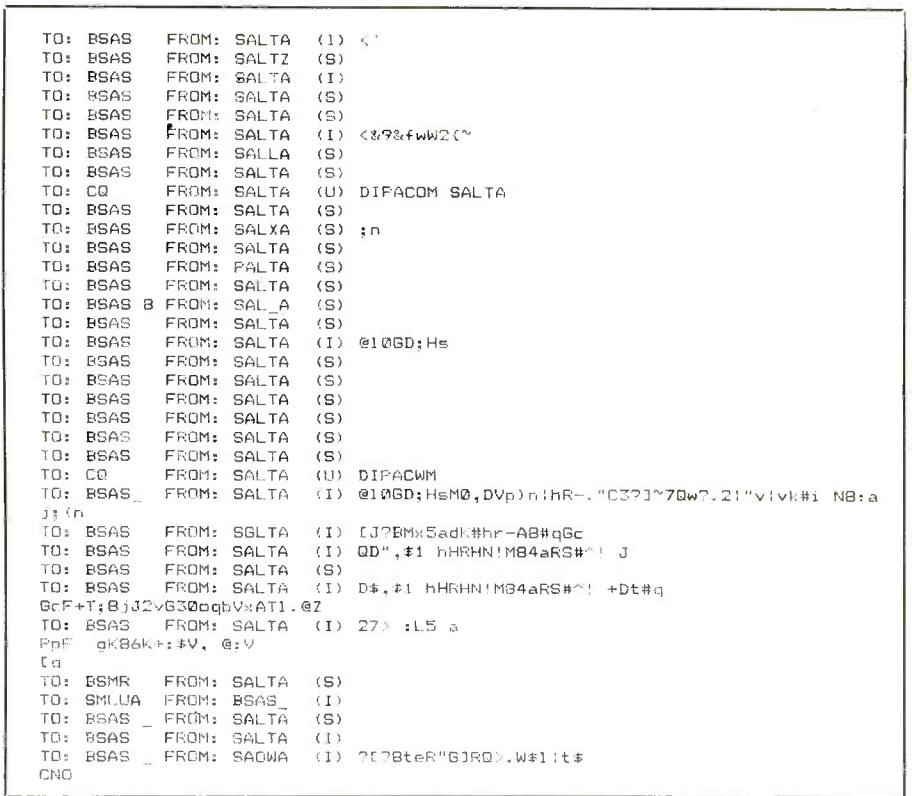

Figure 1

is a dr enroute to your loc now. You will rtn to this loc now. Out."

But this didn't stop either soldier from continuing to use dirty words. After a few more minutes, "Acorn" broke in and typed, "This is Acorn. This means of comms is for tx of correct form and nature, not for some kind of game. Do you understand? Did you receive my last tx? Over. Nothing heard. Out."

There was a pause for maybe a couple of minutes after "Acorn's" stern interruption. You could feel the tension mounting. CHA then told his pal, "Now you've done it. He's on his way to your loc right now." Communications were suddenly broken off and nothing

was heard on the frequency for the rest of the day.

Colombian drug busting activity was the subject of numerous RTTY reports coming out of Bogota in June and July. The Spanish-language reports were broadcast sometimes on 8001.5 kHz, and other times on 8297.4 kHz. The ARQ transmissions usually began some time after 0000 UTC and detailed the activities of the "policia antinarcoticos," focusing mainly on what was seized.

Here is an excerpt from my logsheets of July 8, showing the vast amount of activity that occurred within a 20 kHz bandspread in less than an hour: Tuned to 16806.5 kHz at

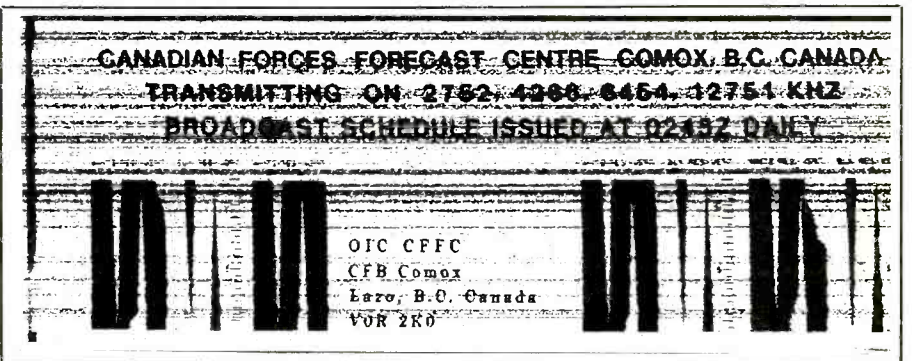

Radiofax test broadcast of CKN, Canadian Forces Meteo, Vancouver, BC, Canada, runs daily at 1515 UTC on 12753 kHz, 120/576. (From Robert Margolis)



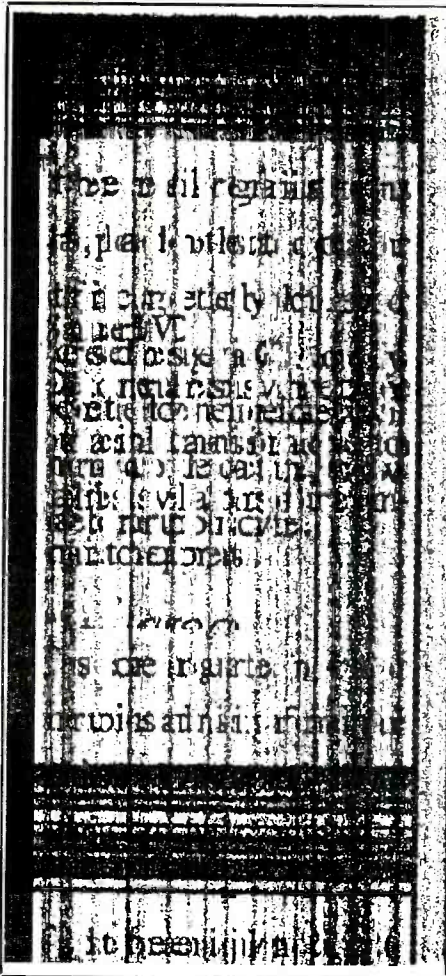

Figure 2

1639 UTC. Found NMF, U.S. Coast Guard, Boston, MA, sending navareas and hydro-lants in FEC mode. Stayed until the end of the transmission then tuned to 16787 kHz. Saw an unidentified station sending news in English in FEC mode at 1654. Deep fadeouts played havoc with the broadcast. Last item, sports, read, "Magsanoc leads Shell... (fadeout here)... back in full force last night to key Shell's 98-93 overtime win over the Alaska Milk in the... (another fadeout)." Signal gains enough strength to see the end of the transmission, "Okey see u later/next time 73 de JO (misprinting here) bye bi bi bi." Tuned down 500 Hz to 16786.5 kHz at 1704 UTC. Observed an unidentified station sending what appeared to be news in German about the European shipping industry. Mode was FEC. News ended at 1713. Tuned upward to 16788.8 kHz and found the same FEC station that was on 16787 kHz 20 minutes earlier. By strange coincidence, the same sports item was being sent. Printout read, "... Shell's 98-93 overtime win over Alaska Milk in the PBA all Filipino conference at the NASA in Pasig." There followed a brief financial quotation and then the language changed to Pilipino. More news for a couple of minutes. Halted abruptly with, "BKKKBKK." Nothing heard after that. Transmission did not run the next day. Don't know if this is the



Unavailability message issued on radiofax by AJE, U.S. Air Force, Croughton AB, England. Was sent on June 21, 1992 on 7597 kHz at 2138 UTC, 120/576. (Submitted by Ary Boender of The Netherlands)

same Filipino station as the one found on 16692.5 kHz in January, and which I wrote about in the May column.

Just send the bill to your happy Muscovite: The Russian foreign affairs ministry was on the air for less than 14 minutes, 13 of which were spent sending RY's along with its RCF callsign, and 30 seconds for a coded message containing five-figure groups. The 75-baud transmission began at 1430 UTC, July 8, on 16203 kHz.

GYA, the Royal Navy, London, England, operated RTTY for a long time on 8149 kHz. Suddenly last July it was gone. In its place was someone using the callsign PBB on a frequency band availability tape sent at 75 baud at 0207 UTC. Is PBB the Dutch Navy? Or is the Queen's Fleet using another mysterious callsign, like MTO, that seemed to come out of nowhere to supplant the GYA callsign found on other frequencies? Stay tuned for the latest developments.

Midshipmen at the U.S. Naval Academy, Annapolis, MD, ran a packet radio BBS on 6261.8 kHz in July. The time of operation was around 0000 UTC.

U.S. Army MARS stations in Georgia, Florida, Kentucky, Tennessee, and South Carolina, had an uninvited guest on their packet radio net last July 8. She cared not one iota about them as she garbled each and every one of their RTTY messages. She stayed around for just 25 minutes, enough time to disrupt the net. They were on 6825 kHz at 0300 UTC, and by coincidence so was she. Her assignment: delivering five-figure groups in Spanish on the AM band.

A similar fate was suffered four days later

by the U.S. Air Force. I was tuned to 11122 kHz, the radiofax frequency of KGWC, Offutt AFB, Elkhorn, NE. A printout was in progress of a weather chart that began being sent at 1445 UTC. The quality of the printout was exceptionally clean and clear, considering that a couple of days earlier the station signal was pretty rotten.

At 1500 UTC, the signal just about disappeared, and the weather charts suddenly became very black. The culprit was immediately found. On 11123 kHz AM was the voice of a YL in English repeating strongly, "986. 986. 1-2-3-4-5-6-7-8-9-0."

Meanwhile, the transmission of the weather chart ended at 1503 UTC, and seven minutes later, the YL began delivering a coded message in 3/2-figure groups. She droned on until 1551 UTC, and Offutt did not send any faxes during that time.

Since Offutt does not adhere to any schedule for fax transmissions, there were hardly any weather charts sent for several hours after this episode. Subsequent transmission times were at 1632, 1642, 1812, 2104, and 2212 UTC. Fortunately the YL never returned and no more charts were ruined.

The French government maintains a RTTY net with the four research bases that comprise the Southern and Antarctic Territories (Terres Australes et Antarctiques Francaise, or TAAF). The net is one of the only links the bases have with the outside world.

Three of the bases are in the Kerguelen islands, 48.50S, 68.70E; Crozet Islands, 46.00S, 50.52E; and Amsterdam and Saint Paul Islands, 38.39S, 77.00E. The fourth base, Terre Adelie, is on Antarctica, between

# NOW YOU'RE TALKING!

## The Code-Free Ham License is Here

Enjoy all Amateur Radio privileges above 30 MHz without having to pass a code test. All you have to do is pass a 55-question exam on basic radio and the FCC regulations. ARRL's new book, **Now You're Talking** makes understanding what is required on the test a snap! And there are exams given all over the country every weekend.



Just think how much fun you'll have communicating through repeaters, enjoy Sporadic E skip and worldwide communications on six meters when conditions are right. There's satellite communication and you can even talk to Astronauts and Cosmonauts in orbit. Enjoy friendly local communication both direct and through repeaters. Help with disaster drills and the real thing! Sound like fun? It is! Order your copy of **Now You're Talking** below: Enclosed is \$19 plus \$4 for shipping (a total of \$23) or charge \$23 to my ( ) VISA ( ) Mastercard ( ) Discover ( ) American Express

Signature \_\_\_\_\_  
 Acct. No. \_\_\_\_\_  
 Good from \_\_\_\_\_ Expires \_\_\_\_\_  
 Name \_\_\_\_\_  
 Address \_\_\_\_\_  
 \_\_\_\_\_  
 City State Zip PC

**THE AMERICAN RADIO RELAY LEAGUE**  
 225 MAIN STREET  
 NEWINGTON, CT 06111

CIRCLE 138 ON READER SERVICE CARD

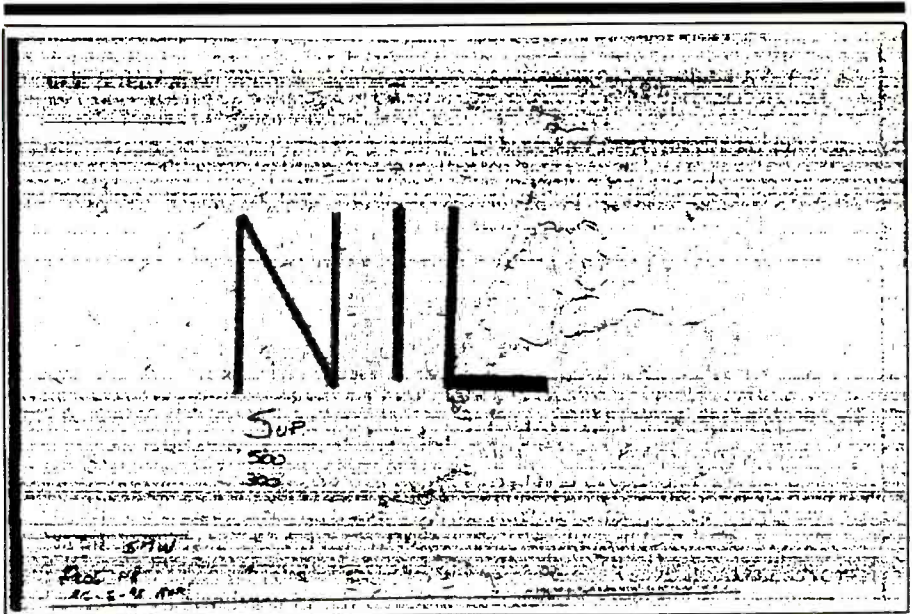

Unavailability message sent by radiofax station LRO84, Buenos Aires Meteo, Argentina. Was monitored June 24, 1992 on 18093 kHz at 2200 UTC, 120/576. (Logged by Robert Margolis)

136 degrees and 142 degrees East, and south of 60 degrees South.

The Territory of the TAAF was created Aug. 6, 1955 for scientific and environmental research, and is overseen by an administrator in Paris. The scientific stations are permanent. Its staff is renewed annually and forms the only population, which was 210 scientists in 1985.

Robert Hall of the Republic of South Africa, continues the narrative: "Each of the four locations has small French communities who keep in touch with one another and with the outside world by shortwave radio, often using a link with Paris via Reunion Island. The overall control is by the Direction des Telecommunications des Reseaux Exterieurs (DTRE), and the RTTY modes used are ARQ-E and ARQ-E3.

"There are several frequencies in use, the best known being 24457.8 and 24458.8 kHz, listed in one frequency guidebook as "DTRE Dumont d'Urville (the research station at Terre Adelie—Ed.)." The callsigns are FJY2 for Kerguelen, FJY3 for Dumont d'Urville, FJY4 for Martin de Vivies Meteo on Amsterdam Island, and FJY5 for Crozet Island.

"At 1018 UTC on June 18, I picked up Paris and the four Antarctic bases all chatting away on 23191.9 kHz using ARQ-E3/96. The traffic was in French and consisted mainly of personal messages. Paris used the callsigns RFGW and TAAF, and, making use of the Reunion relay, RFVIC, addressed the four bases as "DISAMS" (Amsterdam), "DIS-CRO" (Crozet), "DISKER" (Kerguelen), and "DISTA" (Terre Adelie)."

It's always a pleasure hearing from you, Bob. Your detailed reports add much interest to these pages.

Mystery solved: In August's column, I asked for the identity of an ARQ and CW sta-

tion with the callsign "FDE," which I heard on 12616.3 kHz. And old frequency guide says FDE is the French Air Force, Villacoublay, France.

Every Thursday at around 1430 UTC, DDK6, Pinneberg Meteo, Germany, usually sends a radiofax test chart. One Thursday last June, I had my M-800 fax converter set to 120/576 while getting printouts from DDK6 for over an hour. The time arrived for the test chart transmission. Suddenly, the M-800 shifted speed to 240 r.p.m. and the printer began to run. As the teletype paper advanced I saw no test chart being printed. In its place was some kind of text in English. It was difficult to read many of the words. The test made no sense to me (see figure 2). Do any of you know the purpose of this transmission? Please let us know.

The U.S. Navy occasionally hops, skips, and jumps to broadcast radiofax weather charts on frequencies they don't normally use for that purpose. Sometimes they pick a clear channel; sometimes they don't. July 4 was one day they didn't.

At 1432 UTC that day, I was reading news copy from Prensa Latina, Havana, Cuba, on 14928 kHz. I heard in the background the scratchy noise of a radiofax signal. Turning on the M-800, I tried to get a decent printout but couldn't. The radiofax station's signal was clearly overpowered by the Cuban RTTY signal. Heavy black streaks covered most of the chart, allowing very little detail to be seen. But there were enough details to determine that it was a U.S. Navy weather chart from either Hawaii or Guam. It was a 24-hour prognosis of weather in the Western Pacific Ocean.

Suffering a similar fate last June was Bracknell Meteo, England. Some time ago it decided to operate radiofax broadcasts on 13366 kHz. Right next door, on 13365 kHz, is the RTTY station 5YD9, Nairobi Aero, Kenya.

\*\*\*\*\*

TROPICAL CYCLONE 14P (CLIFF)  
 080000Z FEB 92 WRNG NR 05  
 LCTD NR 22.75 136.0W  
 WND5 050G065 KTS  
 MVG 155 AT 14 KTS

\*\*\*\*\*

12HRS 25.9S 135.2W 055G070 KT  
 24HRS 29.3S 134.3W 045G055 KT  
 48HRS 35.5S 130.2W 045G055 KT

\*\*\*\*\*

*Tropical cyclone warning sent via radiofax by NMC, U.S. Coast Guard, San Francisco, CA. Sent Feb. 8, 1992 on 6453 kHz at 0545 UTC, 120/576. (Submitted by Robert Pizzi of California)*

The two generally operate in the same time slot. One night, Nairobi moved its signal upward one kilohertz, landing right on top of Bracknell's signal, thereby adding a whole slew of unwanted isobars to the weather charts.

Returning to the Navy for a moment, it anchored one day in May on 16025 kHz. This frequency normally is used by BAF9, Beijing Meteo, China, for its radiofax operation. I had tuned to the frequency hoping to get some Chinese weather maps, but was surprised to see instead a prognosis map of the Pacific Ocean either from the Navy base in Hawaii or Guam. Other charts were sent by the Navy throughout the day, so I was never able to get anything from the Chinese weather station.

There was an unusual radiofax broadcast on July 2 on 14626.5 kHz. It consisted of weather charts from Ice Center, Ottawa, Ontario, Canada, being sent to an aircraft identified only as "Kay Nine Three (K93)." Identification was heard in upper sideband voice communications between the two on 14624.4 kHz.

I tuned in the fax transmissions at 1454 UTC and stayed with them until about 1830, when the charts became too dark to be read. Ice Center seemed to be pushing a puny signal into the air. Although the radio signal was clear, the map features on most charts were either too light or too dark. There was no happy medium. Clearly a boost in power was needed. Those aboard the aircraft apparently were experiencing the same problem with the signal that I was, for at one point someone complained to the Ice Center that the "trans-

missions didn't come out very nicely." And this aircraft was several thousand feet in the air at the time, flying to Cambridge Bay, Northwest Territories.

I recognized one map as being an ice concentration chart. Other charts showed land and water features, but it was too difficult to determine any locations because of the poor reception.

On July 10, Bracknell Meteo, England, radiofaxed weather charts on a new frequency—6830 kHz. I came across the transmission at 2345 UTC and saw several charts about 13 minutes apart at 120/576. Printouts were terrible, but enough features were visible to determine that the charts were from Bracknell.

On July 11, an unidentified U.S. Navy station faxed weather charts on 22325 kHz. The closest frequency to this one, carrying Navy radiofaxes, is 22322.5 kHz, where NDT in Yokosuka, Japan, is listed in one frequency guide. The faxes I saw followed one of the two schedules of NPN, Apra Harbor, Guam. I tuned in the station at 1645 UTC, while a surface prognosis chart was being faxed. A satellite imagery chart followed at 1650, and then a surface analysis chart at 1707. Transmission on this frequency ended at 1727. All charts suffered deep fadeouts of the fax signal. Question: Is this station NDT or NPN?

#### RTTY Intercepts

**2110.4:** "AAA" w/crypto to "CQ," packet at 0354. (Ed.)

**2805.0:** CCS, Santiago Navrad, Chile, w/RYRY at 0329, & msgs + 5L grps at 0331, 100 baud. (Ed.)

#### Abbreviations Used in The RTTY Column

AA	Arabic
ARQ	SITOR mode
BC	Broadcast
EE	English
FEC	Forward Error Connection mode
FF	French
foxes	"Quick brown fox . . ." "test tape"
GG	German
ID	Identification/led
MFA	Ministry of Foreign Affairs
nx	News
PP	Portuguese
RYRY	"RYRY . . ." "test tape"
SS	Spanish
ffc	Traffic
w/	With
wx	Weather

**3175.5:** LOR, Puerto Belgrano Navrad, Argentina, w/weather msgs at 0100, 75 baud. (Fred Hetherington, FL)

**4246.0:** Un-ID w/msgs possibly in Cyrillic, w/RYRY + "vmgtcnjbb" after each msg. Was 100 baud at 1850. (Ary Boender, NLD) Cyrillic? Nyet. It's not Cyrillic, it's encryption, although pronunciations of the two seem similar. The RYRY & "vmg . . ." is used to make sure the sending & receiving stas are in sync with each other. We here in the States see this stuff all the time on many freqs. A majority of the freqs are listed as being used by the U.S. Navy—Ed.

**4460.0:** Un-ID w/RYRY, 50 baud, 0030-0150. (Hetherington, FL)

**5233.3:** AJE, USAF, Croughton AB, England, w/EGWR wx data at 0140, 75 baud. (Hetherington, FL)

**5240.0:** 4OC2, Tanjug, Belgrade, Yugoslavia, w/nx in EE at 0308, 50 baud. (Ed.)

**5740.0:** HZN46, Jeddah Meteo, Saudi Arabia, w/coded wx at 0416, 50 baud. (Mark Burkart, LA)

**5814.0:** Un-ID w/RYRY, 50 baud at 0025. (Burkart, LA)

**5904.0:** AFS, Offutt AFB, Elkhorn, NE, w/KAWN wx data, 75 baud at 0520. (Ed.)

**6979.5:** CCS, Santiago Navrad, Chile, w/5L grps to EBJY et al, 100 baud at ???? UTC. (Hetherington, FL)

**7723.5:** Un-ID w/brief RYRY and nothing else, 100 baud at 0055. (Ed.)

**7841.5:** Possibly a Mexican sta. w/a msg in SS, 100 baud at 0109. (Ed.)

**7915.0:** AGA1WP at Wright-Patterson AFB, Dayton, OH, w/its packet radio BBS in op at 1830. (ed.)

**8098.0:** Un-ID, possibly an oil rig, w/an ARQ msg at 0557 re a fuel oil spill & a broken pump handle. U.S. sailing vessel, possibly named Coastal Ranger, w/Jason the radio op chatting w/Steve in ARQ mode at 0952. Vessel was in the Pacific Ocean off the U.S. coast. Freq. is not within the maritime RTTY band. (Ed.)

**8421.0:** VIS74, Sydney R., Australia, w/a telex to 9MVZ, ship Pernas Arang (Malaysian cargo), ARQ at 1019. (Ed.)

**8673.0:** MTO, Royal Navy, Rosyth, Scotland, w/availability reports, 75 baud at 0100. (Hetherington, FL)

**10408.0:** 9VF63, ANSA, Singapore (relay sta.), w/nx at 1655, 50 baud. (Boender, NLD)

**11638.0:** DDK8, Pinneberg Meteo, Germany, w/a gale warning in EE & GG, sandwiched between RYRY tests. Was 50 baud at 1759. (Ed.)

**12548.5:** YWMI, Maracaibo Navrad, Venezuela, w/world nx in SS at 0048, 75 baud. (Ed.)

**12583.5:** CBV, Valparaiso R., Chile, wkg ship c/s OVII, ARQ at 2347. (Ed.)

**12597.0:** SPB62, Szczecin R., Poland, w/a tfc list, FEC at 1010. (Boender, NLD)

**12615.0:** UXN, Arkhangelsk R., Russia, w/telexes in RR at 1722, ARQ. (Ed.)

**12906.0:** MTO, Royal Navy, Rosyth, Scotland, w/an availability rpt at 0947, 75 baud. (Boender, NLD)

**13412.0:** NMF, U.S. Coast Guard, Boston, MA, w/tfc to NRCB, cutter Eagle, ARQ, 1846-1943. (Ed.)

**13444.4:** FUV, French Navy, Djibouti, idling, ARQ-E3/96 at 1942. (Hall, RSA)

**13530.0:** RVW53, Moscow Meteo, Russia, w/coded wx, 50 baud at 0928. (Boender, NLD)

**13802.5:** RCR78, Khabarovsk Meteo, Russia, w/cod-  
ed wx, 50 baud at 1747. (Ed.)  
**14367.0:** BZP54, Xinhua, Beijing, China, w/nx in  
EE, 75 baud at 1128. (Boender, NLD)  
**14395.3:** AJE, USAF, Croughton AB, England,  
w/EGWR wx data, 75 baud at 2023. (Ed.)  
**14452.0:** HMF57, KCNA, Jungsan, North Korea,  
w/RYRY, 50 baud at 1132. (Boender, NLD)  
**14468.5:** Un-ID w/5L grps + headers consisting of  
5 groups of 5F beginning w 11177. Was 75 baud,  
1751-1759. (Ed.)  
**14478.5:** Possibly MFA, Vienna, Austria, w/a circular  
in 5F grps & msgsin GG. Was ARQ-S6/96 at 1415. (Ed.)  
**14486.0:** RFGW, MFA, Paris, France, w/a msg in FF

at 1423, FEC-A/144. ("Gal of Liberia," Italy)  
**14527.0:** TAD, MFA, Ankara, Turkey, w/5L grps  
at 1515, FEC-A/144. ("Gal of Liberia," Italy)  
**16046.0:** Un-ID w/encryption, UN-ARQ/240 at  
2355. (Ed.)  
**16164.0:** OEC, MFA, Vienna, Austria, w/s/off in EE,  
ARQ-S6/96 at 1317. (Ed.)  
**16183.0:** Un-ID w/aero wx, 50 baud, 1956-2130.  
(Ed.)  
**16201.5:** CCS, Santiago Navrad, Chile, w/RYRY &  
SGSG, 75 baud at 1715. (Ed.)  
**16203.0:** RCF, MFA, Moscow, Russia, w/RYRY at  
1438, foll by 5F grps at 1444, w/QRU SK about 30  
seconds later, 75 baud. (Ed.)

**16254.2:** TAD, MFA, Ankara, Turkey, w/5L grps,  
FEC-A/144 at 1700. ("Gal of Liberia," Italy)  
**16345.0:** CLP8, Cuban Embassy, Conakry, Guinea,  
w/diplo t/c at 1937, 50 baud. (Burkart, LA)  
**16806.5:** NRV, U.S. Coast Guard, Guam,  
w/plaintext wx, FEC, 1506-1516. (Ed.)  
**16809.0:** WLO, Mobile R., AL, w/foxes & 10 count,  
ARQ  
at 1625. (Ed.)  
**16818.0:** SVT6, Athens R., Greece, w/a t/c list at  
0012, ARQ. (Ed.)  
**17020.0:** UDK2, Murmansk R., Russia, w/telegrams  
t/c, 50 baud at 1832. (Ed.)  
**17117.5:** PBC317, Goeree Island Navrad, The  
Netherlands, w/an availability tape at 2335, 75 baud.  
(Ed.)

**17197.6:** LOR, Puerto Belgrano Navrad, Argentina,  
w/5L grps, 96 baud at 1712. (Robert Hall, RSA)  
**17456.8:** MFA, Cairo, Egypt, w/t/c to African em-  
bassies, ARQ at 1705. (Hall, RSA)  
**17646.0:** "V5G," MFA, Bucharest, Romania, w/nx  
in Romanian, Spread 51/102.75 at 1513. ("Gal of  
Liberia," Italy)  
**18102.9:** Un-ID Egyptian diplo, on amateur radio  
freq., w/t/c in AA, ARQ at 1507. (Ed.)  
**18189.0:** Un-ID w/5L grps, 75 baud at 1314. (Ed.)  
**18450.5:** RCF, MFA, Moscow, Russia, w/RYRY foll  
by 5F grps, 75 baud at 1445. (Manthey, NY)  
**18972.0:** DFZG, MFA, Belgrade, Yugoslavia, w/nx  
in EE & SC, 75 baud at 1450. (Manthey, NY)  
**19031.6:** ACC60, U.S. Army MARS, Heidelberg,  
Germany, in packet radio comms at 1207 w/AEM1USA  
and AAA3USA. (Hall, RSA)  
**19091.7:** MFA, Jakarta, Indonesia, w/nx in EE & In-  
donesia, 50 baud at 1150. (Hall, RSA)  
**19115.3:** MFA, Jakarta, w/nx in EE, ARQ at 1450.  
(Manthey, NY)  
**19117.5:** MFA, Jakarta, w/t/c in Indonesian, ARQ at  
142. (Hall, RSA)

**19756.6:** MFA, Jakarta, Indonesia, w/nx in EE,  
FEC-S/96 at 1407. ("Gal of Liberia," Italy)  
**19980.0:** 9BC33, IRNA, Teheran, Iran, w/nx in EE,  
50 baud at 1530. (Manthey, NY)  
**20058.0:** MFA, Pyongyang, North Korea, w/5F grps,  
50 baud at 0340. (Takashi Kuroda, Japan)  
**20253.9:** TAD, MFA, Ankara, Turkey, w/5L grps,  
FEC-A/144 at 1425. ("Gal of Liberia," Italy)  
**20348.4:** Un-ID using ARQ-M2/96 mode at 1037.  
(Hall, RSA) It's 9RE203, PTT, Lumbashi, Zaire, and the  
circuit is to Brussels. The mode used is ARQ-M2-242 and  
not ARQ-M2-342, which may be the reason no copy was  
forthcoming.

**20401.5:** Indonesian Embassy, Nairobi, Kenya,  
w/msgs in Indonesian. ARQ at 1544. (Ed.)  
**20402.3:** YWM1, Maracaibo Navrad, Venezuela,  
w/RYRY & SGSG, 75 baud at 1620. (Manthey, NY)  
**20556.4:** RFGW, MFA, Paris, France, w/5L grps,  
FEC-A/144 at 1449. ("Gal of Liberia," Italy)  
**20596.0:** HBD20, MFA, Geneva, Switzerland, w/5L  
grps, ARQ at 1556. (Burkart, LA)  
**20691.5:** PWX33, Brasilia Navrad, Brazil, w/RYRY  
& SGSG, 75 baud at 1411. (Ed.)  
**20693.9:** "BRTH," French Embassy, Beirut,  
Lebanon, w/5L grps at 1600, FEC-A/192. ("Gal of  
Liberia," Italy)  
**20814.2:** RFTJD, French Forces, Libreville, Gabon,  
idling, ARQ-E3/48 at 1206. (Hall, RSA)  
**20919.5:** SAM, MFA, Stockholm, Sweden, w/5L  
grps, SWED-ARQ at 1118. (Hall, RSA)  
**20987.0:** SAM, MFA, Stockholm, w/t/c to Lima,  
Peru, SWED-ARQ at 1458. (Hall, RSA)  
**21408.1:** MFA, Lagos, Nigeria, w/nx in EE, FEC-  
A/96 at 1540. ("Gal of Liberia," Italy)  
**22904.5:** DMK, MFA, Bonn, Germany, w/a msg to  
Tokyo, ARQ-E/96 at 0310. (Kuroda, Japan)  
**22913.0:** Un-ID w/encryption, ARQ-E/192 at 0720.  
(Kuroda, Japan)

**23355.0:** CLP18, Cuban Embassy, Dar-es-Salaam,  
Tanzania, w/diplo t/c, 50 baud at 1810. (Burkart, LA)  
**23615.0:** Un-ID w/encryption, ARQ-E/192 at 0819.  
(Kuroda, Japan)  
**23697.6:** DFX69, PIAB, Bonn, Germany, w/nx in  
GG, FEC-A/96 at 1435. (Manthey, NY)  
**24037.0:** CLP45, Cuban Embassy, Luanda, Angola,  
relaying msgsin from CLP18 to CLP1. Was 75 baud at  
1839. (Burkart, LA)  
**24458.3:** Un-ID in FF, ARQ-E/96 at 0830. (Kuroda,  
Japan)

**TOUCH-TONE DECODER/DISPLAY  
& ASCII CONVERTER BOARD**



Model TDD-8 decodes and displays all 16 DTMF digits and provides an ASCII serial output. Digits are displayed on eight LED's. 32 character memory can be scrolled. It will accept almost any audio source, such as a scanner, tape recorder, telephone answering machine, etc. Serial output can be connected to your computer. IBM compatible software included for displaying, storing and/or printing time, date and number for automatic logging.

**TDD-8 DTMF DECODER/DISPLAY/ASCII** \$99  
**CAB-1 AUDIO & COMPUTER CABLES** \$20  
**PS-12 110VAC TO 12VDC POWER PACK** \$10  
add \$5 S/H - VISA/MC ACCEPTED

**MoTron Electronics** TEL: 1-800-338-9058  
310 Garfield St.#4 (503)-687-2118  
Eugene, OR 97402 FAX: (503)-687-2492  
(Touch Tone is a trademark of AT&T)

**YOU AIN'T HEARD NOTHIN'...YET**

Since 1967, CRB Research has been the world's leading publisher and supplier of unique hobby and professional books and information including.

Scanner Frequency Guides  
Shortwave Frequency Guides  
Military/Federal Communications  
Broadcast Station Registries  
Undercover Communications  
Survival Communications  
& Other Related Topics

Ask for Big Free Catalog!

**CRB RESEARCH**  
P.O. Box 56, Commack, NY 11725

CIRCLE 109 ON READER SERVICE CARD

**SUPER 12 HOUR RECORDER**

**CALL TOLL FREE**

Modified Panasonic Slimline,  
6 hrs per side  
120 TDK tape furnished.  
AC/DC Operation.  
Quality Playback.  
Digital Counter.  
Durable Lightweight Plastic.



**\$119.00\***

**PHONE RECORDING ADAPTER**

Starts & Stops Recorder  
Automatically When  
Hand Set is Used.  
Solid State!



FCC Approved

**\$28.50\***

**VOX VOICE ACTIVATED CONTROL**

Solidstate Adjustable  
Sensitivity. Voices &  
Sounds Activate Recorder  
Adjustable Sensitivity  
Provisions for Remote  
Mike



**\$28.50\***

\* Add for ship. & handling. Phone Adapter & Vox \$2.00 each, Recorders \$5.00 each. Colo. Res add tax. Mail Order, VISA, M/C, COD's OK. Money Back Guar. Qty Disc. available. Dealer inquiries invited. Free data on other products.

**AMC SALES INC.** 193 Vaquero Dr.  
Boulder, CO. 80303  
Phones (303) 499-5405 1-800-926-2488  
FAX (303) 494-4924  
Mon-Fri 8-5 MTN. TIME

CIRCLE 67 ON READER SERVICE CARD

**KILL THE NOISE!**

WITH THE NEW INNOVATIVE NXL  
INDOOR ACTIVE LOOP ANTENNA

\* Special shielded loop inherently reduces all local man-made noise, including power line buzz and noise from computers, TV's, light dimmers, motors. \* Loop can be turned and tilted to further null out any specific noise source. \* Features internal high-gain amplifier and 1.8 to 30 MHz tunable preselector. \* Uses 9-volt battery or optional AC supply (\$8.95). \* Rivals or outperforms any indoor or outdoor antenna! \* Only \$89.95 + \$5.00 shipping (Canada: \$9.50). Specify type output connector. \* Other products available, send SASE for complete catalog. Worldcom Technology, P.O. Box 3364, Ft. Pierce, FL 34948 (407) 466-4640.

**PAY TV AND SATELLITE DESCRAMBLING**  
ALL NEW 1992 EDITION ALL NEW

1992 Edition Updates Latest Circuits, Turn-Ons, Bypasses, Bullets, Bags, Blackpichers, VCI Plus and B-Mac Fixes. Only \$15.95. *VCI Wizard Hacker's Bible includes Plus Tells All.* \$15.95. Pay TV And Satellite Descrambling Vol 1 (Basics), 1989, 1991 Editions Are All Different. \$14.95 Each. MDS Handbook \$9.95. Satellite Systems Under \$600 \$12.95 (52). Any 3/\$29.95 or 5/\$49.95. Scrambling News Monthly Will Keep You Up To Date On Plus Breaks \$24.95/Yr. Special. Everything We Have Including Video. \$109.95. New Catalog \$1.

Scrambling News 1552P Hertel Ave  
Buffalo, NY 14216 Voice/FAX (716) 874-2088  
COD S.A.R.E. OK ADD \$6

**212-925-7000**

**SHORTWAVE RECEIVERS, HAM RADIOS, BOOKS,  
ANTENNAS, SCANNERS, Business Radios,  
ICOM, YAesu, KENWOOD, SONY, PANASONIC,  
MOTOROLA.**

... our 40th Year ... Worldwide shipping.  
Sales ... Service. Large Showroom. Open 7 days.

**Barry Electronics Corp.**  
WORLD WIDE AMATEUR RADIO SINCE 1950  
Your one source for all Radio Equipment!

Fax 212-925-7001  
512 Broadway, NYC, NY 10012

CIRCLE 69 ON READER SERVICE CARD

# LISTENING POST

BY GERRY L. DEXTER

## WHAT'S HAPPENING: INTERNATIONAL SHORTWAVE BROADCASTING BANDS

**S**ome major shortwave broadcast DX news arrived, just as we were beginning preparation of this month's column—an opportunity to add an extremely rare country to our logs! Radio St. Helena, broadcasting from St. Helena Island in the south Atlantic, will air a special shortwave broadcast on 16 October, at about 2000 UTC on 11092. A repeat transmission will air from about 2240 to 2300. This is the station that aired a special shortwave broadcast two years ago, in conjunction with a DX contest put on by European clubs. It was heard by quite a few DX'ers in North America, but a lot of listeners, including yours truly, missed it. Now and then the DX gods allow us a second chance. The station doesn't have shortwave equipment of its own. The broadcasts are aired over a point-to-point transmitter. We don't have any specific information about sending reception reports but the regular address, Radio St. Helena, Broadway House, Jamestown, Island of St. Helena, (South Atlantic Ocean), will probably do the trick.

If they air voice IDs, standard time and frequency stations are usually considered shortwave broadcasters—a convenient interpretation that enables us to count Hawaii, via WWVH. Now, it looks as though Hawaii's going to get a "real" shortwave broadcaster by the end of next year. LeSea Broadcasting, which operates WHRI in Noblesville, Indiana, is going to put a station on Hawaii's Big Island in order to give better coverage of Asia, Australia and the Pacific region. The call letters will be KWHR (World Harvest Radio). KWHR would air WHRI programming, fed via satellite from Indiana.

Radio Lesotho, which had been off the air for several months due to technical problems is active again, though somewhat irregularly. The Maywoods DX Team in Kentucky spotted the station after 0500. Check the loggings section.

Some careful listening might turn up some local AM stations in Argentina, being relayed on shortwave for Argentine personnel in Antarctica. Check 26099 for Radio El Munco, 26139 for Radio Del Plata, both at around 2200. Check 15780 LSB for sports from Radio Continental on weekends. The upper sideband of this military transmitter sometimes carries sports from Radio Mitre.

A very rarely active Colombian station, Radio Buenaventura on 4833 hasn't even been listed on shortwave for several years now. We're still trying to hear this one. There's some heavy QRM from Radio Reloj on 4832 and Radio Tezututlan—4835!

The Polish government is reported to have ordered a 250 kilowatt transmitter so perhaps, a year or two hence, we'll finally get some decent signals out of Polish Radio, after

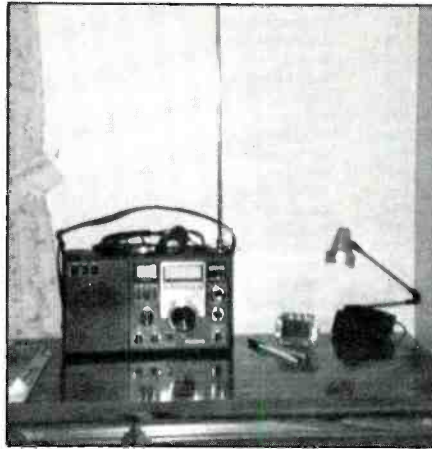

*Regular reporter John Miller of Thomasville, GA turns up a lot of good things using this Panasonic RF-2200 receiver.*

years of reception that varied from marginal at best to stinky at worst.

Here's a bit of news that again proves that the old QSL'ing adage that if you just wait long enough you can find a way to QSL a difficult station. The Ivory Coast has been tough in the QSL department practically since time began, with only very brief QSL'ing activity sandwiched between multi-year "black" periods. Comes now the news that Africa Number One is going to be using the Ivory Coast's 500 kilowatt at Akouedo, near Abidjan, to reach western Africa. Africa Number One is much better in the QSL department so the only remaining challenge would be to get Africa Number One to note the transmitter site on their QSL card.

Here's another new Russian station using shortwave—Radiotrek, broadcasting from Yekaterinburg on 6910 at 1600 to 1800, which is not a good time/frequency combo for us.

You think you've got problems? Radio Tirana had to stop sending QSL's and program schedules because they didn't have any paper to print them on and couldn't afford to buy any. A German DX club came to the rescue by printing and providing a new supply of QSL cards.

Larry Baysinger, W4EJA, spent some time at Radio K'ekchi, Guatemala a few months ago. He helped put up an emergency antenna and a one kilowatt backup transmitter. Larry says the station is financed and operated by the K'ekchi Baptist Association and is the only station in Guatemala broadcasting exclusively in the K'ekchi language. Programs featured religious messages and folk music, health and agriculture, church broadcasts and the announcing of personal messages ("comunicados"). This is an essen-

tial service since there are very few telephones in the area. The station has problems getting the transmitter up to its five full kilowatts due to distribution problems from the local utility, which has had difficulty since guerrillas blew up four of the six power generators there several years ago.

Radio K'ekchi operates on 4845 and is frequently heard in North America during our early morning and early evening hours. The station welcomes reports (in Spanish, please) to: Radio K'ekchi, TGVC, Fray Bartolome de Las Casas, 16015 Alta Verapaz, Guatemala. A big thanks to W4EJA (who is also assistant chief engineer at WHAS/WAMZ, Louisville, for the excellent info!

Our mail this month focuses on clubs. Jill Dybka in Nashville, Tennessee notes that we mentioned a "national shortwave organization" a while back and now can't locate the information. It may have been a reference to the North American Shortwave Association (45 Wildflower Road, Levittown, PA 19057) which publishes a monthly bulletin of articles, loggings and news. It also has an excellent awards program and country list. \$2 to the above address will get you a sample copy of the bulletin.

We've been meaning to also salute the Speedx club and its monthly bulletin "Shortwave Radio Today," which has seen great improvement in the past months. \$2 should get you a sample copy, from PO Box 196, DuBois, PA 15801.

If you live within 150 miles of Chicago, you're invited to join the Chicago Area DX Club. The new head guy is Edward G. Stroh, 53 Arrowhead Drive, Thornton, IL 60476. The club publishes a monthly newsletter and has periodic get togethers. Dues are \$15 per year.

The Voicespondence Club, as the name indicates, promotes communications via cassette tape. Members' interests include shortwave listening, ham radio, old time radio and so on. You can get more information by writing James Langston, 146 Hawthorne Ave., Newport News, VA 23602. Please include a self-addressed, stamped envelope.

We look forward to hearing from you each and every month with your loggings, schedules, station information, spare QSL's we can use for illustrations and . . . shack photos! What a shy bunch we have out there! When you compile your loggings please list them by country, double or triple space between each loggings and include your last name and state abbreviation after each. We cannot take the time to add this for you, and logs which do not contain last name/state abbreviation after each item won't be used. Thanks for your help.

Here are this month's logs. All times are in



Radio New Zealand is sending out these attractive stickers.

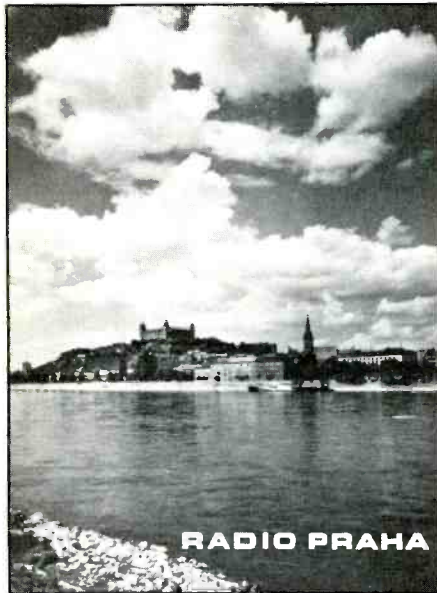

It was Radio Prague for many years, including 1978, when Todd Borsch of IL got this QSL. Now the station calls itself Radio Czechoslovakia.

UTC. Broadcasting language is assumed to be English unless indicated otherwise (SS = Spanish, PP = Portuguese, AA = Arabic, etc.).

#### SWBC Loggings

- Albania:** Radio Tirana, 9580 with news at 0232. (Jensen, IA)
- Algeria:** RTV Algerienne, 9535 at 2230 in FF with midwest music. (Dybka, TN)
- Antarctica:** Radio Nacional Archangel, LRA36, in SS on 15474.9 at 2209. (Low, TX) (Reactivated, editor)
- Antigua:** BBC Relay, 15220 at 1131. (Moser, PA) Deutsch Welle relay, 9670 at 0535 with "Larry Wayne's Diary." (Carson, OK)
- Ascension Island:** BBC relay, 12095 at 1958 with ID, news. (Moser, PA)
- Australia:** Radio Australia, 5995//17400 with news at 1400. 6060 at 1402. (Vaage, CA) 6020 at 0737, 9710 at Papua New Guinea at 0757, 11880 at 1256 sign on, 13605 at 0932, 15240//15320//17715 at 0652. (Lamb, NY) 7240 at 1215, (Northrup, MO) 9580 at 1142. (Tucker, GA) 15240 at 0532. (Jensen, IA) 17795 at 0305. (Low, TX)
- ABC, Perth, 6140 at 1400 with ABC News, oldies. (Zamora, CA)
- ABC, Alice Springs. 2310 at 1046 with pop/rock. (Foss, AK)
- ABC, Katherine, 2485 at 1031 with discussion. (Foss, AK)
- Austria:** Radio Austria International, 6015 (via Canada) at 0530. (Pellicciari, CT) 13730 at 1143 with waltzes. (Moser, PA) 0128 in German, into EE at 0130. (Tucker, GA)

#### Abbreviation Used In Listening Post

AA	Arabic
BC	Broadcasting
CC	Chinese
EE	English
FF	French
GG	German
ID	Identification
IS	Interval Signal
JJ	Japanese
mx	Music
NA	North America
nx	News
OM	Male
pgm	Program
PP	Portuguese
RR	Russian
rx	Religion/fous
SA	South America/n
SS	Spanish
UTC	Coordinated Universal Time (ex-GMT)
v	Frequency varies
w/	With
WX	Weather
YL	Female
//	Parallel frequencies

**Belarus:** Radio Minsk, 17605 at 0040 in unidentified language, possible EE ID. (Moser, PA)

**Belgium:** BRT, 9905 at 2059 and 0859, 17555 at 1130 (Sundays only) in EE. (Lamb, NY) 11695 at 0630. (Dybka, TN) 13655 at 2330 with news of Belgium. (Moser, PA)

**Bolivia:** Radio Eco, 4409.3 in SS with pop/rock at 0145, ID after each song. QRM from a MARS station. (Gasque, SC) Radio Camargo, tentative. 3390.3 at 0040 in SS, poor. (Gasque, SC)

Radio Horizontes, 4509.3 at 0916 in SS, ID at 0910 and 0928. (Gasque, SC)

Radio Santa Cruz, 6135 at 0938 in SS with ID's, date, folk and Latin pops. (Lamb, NY)

Botswana: Radio Botswana, 7255 at 0257 with IS, sign on, anthem. (Moser, PA)

VOA Relay, 15375 at 0501 in Hausa, into FF at 0530. 15600 at 0533. (Lamb, NY)

**Brazil:** Radio Intergracao, 4764.9 in PP with talk at 1015, commercials 1025, ID 1031. (Gasque, SC)

Radio Guarani, 6050 at 2330 with futbol. (Gasque, SC)

Radio Universo, 6060 in PP at 2325 with same game as R. Guarani. (Gasque, SC)

Radio Anhanguera, 6080 in PP with multiple IDs 2320-2322, pops. (Gasque, SC) 11830 at 2304 with IDs. (Lamb, NY)

Radio Bandeirantes, 6090 at 0831 in PP with IDs, jingles, clock and cat sound effects. loud "Hallo Brazil!" (Lamb, NY)

Radio Cancao Nova, 9674.9 at 2025 in PP with talk by man and woman, ID 2031. (Gasque, SC)

Radio Globo, 11805.2 with news in PP at 1103, music followed, with ID after almost every song. (Gasque, SC)

Radio Gaucha, 11915 at 0941 with talk in PP, ID 0958. (Gasque, SC)

Radiobras, 15265 at 1759 with EE ID, address, Brazilian music. Also new, unannounced 15445 at 1159 with IS, ID and "Sunday Special." (Lamb, NY)

**Bulgaria:** Radio Sofia, 9850 at 0314. (Moser, PA) 11720 at 2200. (Pellicciari, CT) 0434. (Carson, OK)

15330 at 1730 with news, frequency announcement. (Dybka, TN)

**Cameron:** CRTV, Yaounde, 4850 at 0506 with EE. (Maywoods, KY)

CRTV, Douala, 4795 at 0449 sign on with anthem, Sunday Mass, choral music. (Lamb, NY)

**Canada:** Radio Canada International, 9700 (via S. Korea) at 1429 with EE/FF ID, 1430 sign on in Chinese. 15150 at 2130 with sign on to Africa. (Zamora, CA)

11845 at 0100 with CBC news. (Tucker, GA) 11940 at 0358 with closing ID. (Carson, OK) 15325 at 1858 with joint RCI/Canadian Forces Network program for Canadian troops in Yugoslavia, in EE/FF. (Tucker, GA)

CFRX, Toronto, 6070 at 2245. (Maywoods, KY)

CBC Northern Quebec Service, 0204 on 9625. (Carson, OK)

**China:** Radio Beijing, 7435 (language unnoted) with talk to 2227 ID and close. (Gasque, SC) 11680 at 0410 with "News About China." (Tucker, GA) 11715 (via Mali) at 0311. (Jensen, IA) 11755 at 0903 with news. (Moser, PA)

CPBS, Xian, 7504 at 1112 with CC music. (Foss, AK)

**Colombia:** Caracol Bogota, 5075 at 0502 in SS but

also with FF ID, Latin jazz music. (Lamb, NY) (reactivated frequency, editor)

La Voz de Guaviare, tentative, 6035.2 in SS at 2340 with sports. (Gasque, SC)

La Voz del Llano, 6115.8 in SS with Latin pops, ID 2314. (Gasque, SC) Radio Nacional, 11822 at 0158 in SS with Latin music. (Dybka, TN)

**Costa Rica:** Radio Reloj, 4832 in SS with news, music at 0600. (Pellicciari, CT)

AWR Costa Rica, 0334 on 5030 with ID, religious talks in SS. (Lamb, NY) 9725 at 2314 with inspirational talk. (Moser, PA)

Radio for Peace International, 7375 at 0320. (Carson, OK) 15030 at 2000 (Maywoods, KY) 21465 at 2331. (Zamora, CA)

**Cuba:** Radio Havana Cuba, 11760 at 0432. (Tucker, GA) 11875 at 0158. (Carson, OK) 11970 at 0413. (Low, TX) 13700 at 0200. (Pellicciari, CT) 17705 at 2055. (Moser, PA)

Radio Rebelde, 3366//5025 at 0340 in SS. (Lamb, NY) 5025 at 0107. (Dybka, TN)

**Czechoslovakia:** Radio Czechoslovakia, 5930//7345 at 0100. (Low, TX) 7345 at 0300. (Moser, PA) 9580 at 0010. (Tucker, GA) 9810 at 0200. (Borsch, IL)

**Ecuador:** HCJB, 9745 at 0045. (Moser, PA) 11730 at 0737, 11925 at 0600 and 15270 at 1940. (Carson, OK) 11910 at 0515 and 15150 at 0229. (Jensen, IA) 17790 at 2130. (Borsch, IL)

HD2IOA time station, 3810 at 0933 with SS time signals. (Moser, PA)

**Egypt:** Radio Cairo, 9475 at 0225. (Dybka, TN) 9900 at 2135. (Borsch, IL)

**England:** BBC, 6195 to Europe at 0442. (Low, TX) 9410 at 0219, 11400 at 2014, 15070 at 1946, 15255 at 0200, 15325 at 0543, 15575 at 0554 and 17880 at 1939. (Jensen, IA) 9515 at 1418, 17840 at 1645. (Vaage, CA) 9915 at 0130. (Tucker, GA)

Radio Japan via Skelton, test transmission on 9770 at 0600 in JJ with IDs. (Lamb, NY)

**Equatorial Guinea:** Radio East Africa, 9555//9585 at 0645 in FF. (Pellicciari, CT)

**Finland:** Radio Finland International, 11755 at 0139 with "Northern Report" and IS, IDs. (Lamb, NY) 15400//17880 at 1259 with announcements. (Moser, PA)

**France:** Radio France International, 17650 at 1430 with ID, "Spotlight on Asia." (Lamb, NY)

**French Guiana:** Radio Japan via RFI's French Guiana relay on 15325 at 0305. (Low, TX)

**Gabon:** Radio Japan relay, 11735 at 2347 with language lesson. (Tucker, GA)

Radio France relay, 4890 at 0407 in FF. (Lamb, NY) 17620 at 1604 with news in EE. (Moser, PA)

**Central African Republic:** RTV Centrafricaine, 5033.7 with music and talk in local language, rooster crows, off suddenly at 0450. (Gasque, SC)

**Ghana:** GBC Radio One, 4915 with world and local news in progress at 2345. (Gasque, SC) 0600 with news. (Pellicciari, CT)

**Germany:** Bayerische Rundfunk, 6085 at 0044 in GG with music and talk. (Tucker, GA)

VOA relay, 6060 at 0527. (Low, TX)

Radio Free Europe, 15135 at 1835 in RR with IDs, pops and opera. (Lamb, NY)

Deutsche Welle, 3995 at 0243 in GG. (Lamb, NY) 6040 (via Antigua) at 0122 and 6145 at 0126. (Dybka, TN) 6085 at 0305 and 17720 at 0610. (Vaage, CA) 9670 via Antigua at 0500. (Pellicciari, CT) 11810 at 0317. (Jensen, IA)

**Greece:** Voice of Greece, 9395 at 0141 with news. (Dybka, TN) 9420 at 0135 with news. (Moser, PA)

R. S. Makedonias, 9935//11595 at 0516 in Greek with ID and news discussion program. (Lamb, NY)

VOA Kavalla, 15205 at 0507. (Foss, AK) 17705 at 0351 in AA. (Lamb, NY)

**Guam:** Trans World Radio, KTWOR on 11805 at 0900 with IS, sign on, ID, religious program. (Moser, PA)

Adventist World Radio—KSDA, 11980 at 1355 to Australia. (Low, TX)

**Guatemala:** La Voz de Nuhuala, 3360 in SS with talks and music bits. ID 0206. (Gasque, SC)

Radio Tezulutlan, 4835.1 in SS with marimba music 1045, ID in SS and Mam, brief jingles, into Mam language program. (Gasque, SC)

Radio Cultural, 3300 in SS at 0139. (Maywoods, KY) 1007 in SS. (Foss, AK)

**Hungary:** Radio Budapest, 9830 at 0254 with DX program and off 0258. (Jensen, IA) 11910 at 0158 with IS,

ID, news. (Carson, OK) 15220 at 0200. (Borsch, IL)

**Hawaii:** WWVH on 15000 at 1231, woman with time checks. (Moser, PA)

**India:** All India Radio on 11620 at 2214 with commentary, ID. (Moser, PA)

**Indonesia:** RRI Denpasar, Bali, 3945 at 1136 in unidentified language. (Foss, AK)

RRI Ternate, Maluku, on 3345 at 1009 in unidentified language. (Foss, AK) (probably Indonesian in both cases, Martyr editor)

**Iraq:** Radio Iraq International, 15210 with news and commentary. (Miller, GA) 17740 at 0040 with news, ID, commentary, harp music. (Lamb, NY)

**Israel:** Kol Israel, 11605 at 2134 with news, commentary. (Moser, PA) 17575 at 2130. (Tucker, GA)

**Japan:** Radio Japan, 5960, via Canada, at 0100. (Pellicciari, CT) 11735 via Gabon and //17810 direct, with news at 2305. (Zamora, CA) 11815//11865 at 1705 with news. (Vaage, CA) 17825 at 0310. (Low, TX)

Radio Tanpa, 6055 in JJ and 1105. (Foss, AK)

**Kenya:** Kenya Broadcasting Corp., 6075 at 0158, ID by man. Lost when Deutsche Welle signed on at 0159. (Maywoods, KY)

**Lesotho:** Radio Lesotho, 4800 at 0511 in Lesotho with religious service. (Maywoods, KY)

**Lithuania:** Radio Vilnius, 11780 at 2312. (Carson, OK)

**Luxembourg:** Radio Luxembourg, 15350 at 2115. (Moser, PA) 0724 with IDs and rock. (Carson, OK)

**Madagascar:** Radio Netherlands relay, 15150 at 1446. (Carson, OK)

**Mali:** Radio Beijing relay, 11715 at 0302. (Moser, PA)

RTV Malienne, 11960.3 in vernaculars at 0845, ID at 0900, local music. (Gasque, SC)

**Malta:** Deutsche Welle relay, 9565 at 0057 with IS to 0100 sign on, news. (Moser, PA)

**Mauritania:** ORTM, 4845 in AA/FF at 2258, ID over IS at 2300, Holy Quran after 2303. (Gasque, SC) in AA at 0630. (Pellicciari, CT)

**Monaco:** Trans World Radio, 6230 at 0342 with IS, 0345 with ID and into GG programming. (Gasque, SC) 9480 at 0632 with sign on procedure. (Carson, OK) 0828. (Moser, PA)

**Morocco:** VOA Relay, 11850 at 0507, parallel with Botswana relay on 9885. (Lamb, NY) 15205 at 1530. (Pellicciari, CT)

RT Marocaine, tentative, 15335 with AA and Arabic music at 2040. (Dybka, TN)

**Namibia:** Namibian Broadcasting, 3290 at 0402, news in EE. (Moser, PA)

**Netherlands:** Radio Netherlands, 6020 at 0120. (Dybka, TN) 9890 at 1435. (Zamora, CA) 15150 (via Madagascar) at 1452 and 17605 at 1555. (Carson, OK)

**Netherlands Antilles:** Radio Netherlands Bonaire relay, 6165//9590 at 0353. (Low, TX)

Trans World Radio, Bonaire, 9515//11885 at 0700 at PP. (Pellicciari, CT) 11930 at 0306. (Moser, PA)

**New Zealand:** Radio New Zealand, 9700 at 1132. (Moser, PA) 17770 at 0200, relaying domestic 2ZB with news, pops, sports. (Adams, MO) 0540 with children's programming. (Dybka, TN)

**Niger:** La Voz du Sahel, 5020 local, pop and reggae music at 0515-0530, FF ID at 0532. (Gasque, SC)

**Nigeria:** Voice of Nigeria, 7255 at 0530. (Maywoods, KY) 0600 with news. (Pellicciari, CT)

**North Korea:** Radio Pyongyang, 9345 at 1220 in KK. (Northrup, MO) 9977 in SS with ID 1205. (Gasque, SC)

Korean Central People's Broadcast Station, 2850 at 1043, in KK, with choral music. (Foss, AK)

**Northern Marianas:** KHBI, 17555 at 1123 with "Curtain Call." (Lamb, NY)

**Oman:** Radio Oman, 11745 in AA at 1413. (Low, TX)

**Pakistan:** Radio Pakistan, 17555 at 1608 with news, interview. (Moser, PA)

**Papua New Guinea:** Radio Morobe, Lae, 3220 at 1154. Language? (Foss, AK) (probably Pidgin English, editor)

Radio Madang, 3260 at 1017 with music selections. (Foss, AK)

Radio West New Britain, Kimbe, 3235 in Pidgin with US pop and country. (Foss, AK)

NBC Port Moresby, 4890 at 1034 with news. (Foss, AK)

**Peru:** Radio El Puerto, 4509.2 at 0100, huayno-style music, SS ID at 0120, more music. (Gasque, SC)

La Voz de la Selva, 4824.5 at 1005 in SS with huaynos, IDs, mentions of Iquitos. (Gasque, SC)

Radio Cora, 4914.5 in SS at 0945 with woman an-

nouncer and huaynos. ID simply as "Cora." (Gasque, SC) 0350 with non-stop tangos, ID drop-ins. (Lamb, NY)

Radio Satellite, 6724.3 in SS with easy listening music, IDs at 0215 and 0220. Pronounces as "sah-ti-li-ti." (Gasque, SC)

Radio La Merced, 6754.6 in SS with mostly talk, multiple IDs at 0119-20. Gone at 0150 recheck. (Gasque, SC)

Radio Ondas del Mayo, 6803.3 in SS with Latin pops, occasional rock. ID 0117. Gone at 0200 recheck. (Gasque, SC)

Radio Quillabamba, 5025 at 0034 with music, clear ID, mentions of Peru. SS. (Moser, PA)

**Philippines:** VOA relay, 9760 at 1407. (Lamb, NY) 15215 at 2230. (Borsch, IL)

**Portugal:** Radio Portugal, 9570//9705 at 0231, sports and travel feature. (Lamb, NY) 9635 at 0241. (Jensen, IA)

RCl via Sines, 11905 at 0400. (Borsch, IL)

Radio Free Europe, via Portugal site, 21745 in PP at 1317. (Low, TX)

**Romania:** Radio Romania International, 5990 at 0200. (Maywoods, KY) 6155//9570//11830//11940 at 0158 with IS, ID and news. 9690 at 1934 with ID, pops and "Youth Club." (Lamb, NY) 9570 at 0430. (Dybka, TN)

**Russia:** Radio Moscow, 7370 at 1409. 11900//11995 at 1711. (Vaage, CA) 10855 USB feeder at 0318 in RR. (Low, TX) 11840 via Cuba at 1357 with frequency announcement. (Moser, PA) 11850 at 0108. (Tucker, GA) 11880 at 0319 and 15375 at 1917. (Carson, OK) 15290, via Bulgaria, at 0150. (Tucker, GA) 15480 at 0143, 17690 at 1950 with sign on. (Jensen, IA) 15595 in RR at 0652. (Foss, AK) 17696 at 1930. (Pellicciari, CT)

Kamchatka Radio, Petropavlovsk, 4485 at 0917 with rock and roll in RR. (Foss, AK)

Magadan Radio, tentative, 9600 at 0230 in presumed RR. (Dybka, TN)

**Rwanda:** Deutsche Welle relay, 7225 at 0400. (Moser, PA)

**Saudi Arabia:** BSKSA, 17760 at 0504 in Swahili with Quran, IDs. (Lamb, NY)

**Senegal:** ORTS, 4890 at 0645 with news in FF. (Pellicciari, CT)

**Seychelles:** BBC relay, 15420 at 0300. (Low, TX)

**Singapore:** BBC relay, 9740 at 1232 to Asia and Australia. (Low, TX) 11750 at 1618. (Zamora, CA) 11955 at 0915. (Gasque, SC)

**Solomon Islands:** SIBC, 5020 at 1009 with music and woman DJ. (Foss, AK) 9545 at 0707 with Pacific music. IDs for "SIBC" and "Radio Happy Isles." (Lamb, NY)

**South Africa:** Radio RSA, on new 4945 at 0357 with IS, EE/PP IDs, news in PP. 7270 at 0156 with IS, ID, anthem, rooster crow, news. (Lamb, NY) 15220 at 0601 with news. (Dybka, TN)

**South Korea:** Radio Korea, 9750 at 1313 with music to ID and sign off. (Moser, PA) 15170 at 0654 with talk. (Foss, AK)

**Spain:** Spanish National Radio, 9530 at 0105 with news and features. (Moser, PA)

Radio Beijing relay, 9690 at 0302. (Moser, PA)

**Sri Lanka:** Radio Japan relay, 15210 at 1710 with feature. (Moser, PA)

Deutsche Welle relay, 17810 at 1857 with IS, site ID, news and 17820 at 0907 with news. (Lamb, NY)

**Swaziland:** Trans World Radio, 5055 at 0401 in GG with choral music, religious talks, into EE with IS and ID and 0432 "Our Daily Bread." (Lamb, NY) 7200 at 0614. (Foss, AK)

**Sweden:** Radio Sweden, 9690 at 0218 with environmental news. (Moser, PA)

**Switzerland:** Swiss Radio International, 6165//13635 at 0426 in EE, into FF at 0430. (Carson, OK) 9650 at 0216. (Moser, PA) 12035 at 0205. (Dybka, TN) 15430 at 1700. (Low, TX)

**Syria:** Radio Damascus, 12085 at 2116, woman with news. (Moser, PA)

**Tahiti:** Radio Tahiti, 15171 at 0349 with island music. FF or Tahitian. (Maywoods, KY)

**Togo:** RTT Togolaise, 5047 in FF at 2210, Afropops from 2215, ID as "Radio Togo" 2228. (Gasque, SC)

**Turkey:** Voice of Turkey, 9445 at 2207 with news, Turkish music, ID at 2208. (Moser, PA) 11895 at 2235, off at 2250. (Dybka, TN)

**Ukraine:** Radio Ukraine International, 7195//7250//11520//12040//12060//12330//15355 at 0012 with news, IDs. (Lamb, NY) 12040 at 0034. (Tucker, GA) 15135 at 2100. (Pellicciari, CT)

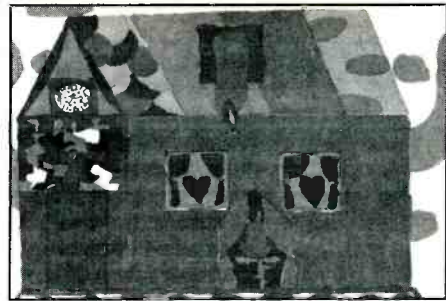

*The Voice of Free China, Taiwan, seems to have an endless supply of attractive QSL's, this one showing art done by orphans in a Taipei children's home.*



**Radio Japan**

*Another champ in the QSL design department is Radio Japan here with a full color photo of Japanese cranes.*

**United Arab Emirates:** UAE Radio, Dubai, 11945//13675//15400 and new 17890 at 0213 in AA with IS, ID, into EE at 0330. (Lamb, NY)

UAE Radio, Abu Dhabi, 13605//15305//17855 at 2215. Into Capital Radio 2230. (Borsch, IL; Tucker, GA)

**United States:** Croatian Radio/Radio Sarajevo, 7315 at 0505 via WHRI. (Dybka, TN) 17760 via WHRI at 1510 in non EE. (Moser, PA)

VOA Greenville, feeder, 6873 USB at 0350, unidentified language. (Gasque, SC)

**Uzbekistan:** Radio Tashkent, 15470 at 1200 with news. (Moser, PA)

**Vatican:** Vatican Radio, 9605 at 0144 in SS. (Carson, OK) 15090 at 2030 with IS, sign on, into FF. (Moser, PA) 17730 at 1627 with IS, ID, Amharic/Tigre program. (Lamb, NY)

**Venezuela:** Radio Nacional, 9540 at 0334 in EE with IS, ID, news, mailbag. (Lamb, NY)

**Vietnam:** Voice of Vietnam, 9840 at 1210 in JJ. (Foss, AK) 10058.9 in unidentified Asian language at 1210, parallel 15009.2. Off 1057, back at 1100. (Gasque, SC)

**Yugoslavia:** Radio Federal Yugoslavia, 11735 at 2115. (Low, TX) 11870 at 0129 with IS, IDs, news, comment. (Lamb, NY)

That's the works—and thanks to those who did the work this month: David A. Gasque, Orangeburg, SC; Marie Lamb, Brewerton, NY; Bjorn F. Vaage, Granada Hills, CA; Todd Borsch, Princeton, IL; Jack K. Adams, Iberia, MO; Brad Low, Jacksonville, TX; Marty Foss, Pitkas Point, AK; Paul Jensen, Mason City, IA; John Miller, Thomasville, GA; John Spencer Carson, Jr., Norman, OK; Robert E. Tucker, Jr., Savannah, GA; Robert Moser, New Cumberland, PA; Steve Pellicciari, Norwalk, CT; Larry R. Zamora, Highland, CA and the Maywoods DX Team: Eric Petty, Jim McClure, Wayne Gregory, Charles Everman, Joel Roitman and Loy W. Lee, Kentucky. ■

# COMMUNICATIONS CONFIDENTIAL

## YOUR GUIDE TO SHORTWAVE "UTILITY" STATIONS

**R**egistered Monitoring Station KKS0CE, manned by Tom Severt who wrote as follows: "I am with the USAF at RAF Chicksands, England. I am a regular utility station monitor and have been listening for a little over a year. I use a Sony ICF-SW7600 receiver with a homemade 7-foot vertical antenna. With this combination I am able to hear stations from all over the world, but I am going to upgrade to a SONY ICF-2010 soon.

My main interest is utility stations, but I also like SW broadcasting and the "spy numbers" stations.

I have been constantly encountering some strange coded Morse groups that include letters, numbers, punctuation, BT's, and several characters I've never heard before such as dit dah dit dah. Traffic is sent for extremely long periods of time. One I logged went on for over three hours."

Tom, the special character you mentioned is the A with two dots over it. It is used by a variety of countries.

Simon Mason, England described a recent observation he had made. "In addition to DFC37/DFD21, there is another number station on the air which uses a callsign before sending its traffic. At various times during the day on 5301 and 8142 kHz, at ten minutes before the hour, VVV DE OLX is sent in CW after which a YL in Czech repeats a 3F group for 5 minutes when she sends a 5F message. For example: At 1945 rapid CW dots; 1950 VVV DE OLX; 1955 YL/CZ repeats '668'; 2000 YL/CZ into 5F text.

According to my utility book, OLX is the callsign of the Czech press agency CETEKA in Prague. I managed to find the address and have sent a prepared QSL card. I'll keep you informed."

Queries relating to the 120 group messages continue to be received from readers. I have not listened to this activity for quite awhile but a few years ago I did spend some time monitoring the transmissions and here is what I noted at the time:

1500 Tone followed by high-speed transmission

1502 Same as 1500

1503 QRA DE H5G-P-T 131500Z GR 120 BT (and into text of 120 groups in CW)

1512 End of message

1515 Tone followed by high-speed transmission

1517 Same as 1515

1519 In second message 131500Z replaced by 131515Z

1528 End of second message

1530 Tone followed by high-speed transmission

1532 Same as 1530

U.S. Department  
of Transportation

United States  
Coast Guard



UNITED STATES COAST GUARD  
COMMUNICATIONS STATION KODIAK  
KODIAK ISLAND, ALASKA  
N O J

COAST GUARD COMMUNICATION STATION  
POST OFFICE BOX 190017  
KODIAK, ALASKA 99619-0017

14 FEBRUARY 1992

MR. DAN GROTE

SHORTWAVE RADIO LISTENER- MR. DAN GROTE  
THANKYOU FOR YOUR RECEPTION REPORT OF COAST GUARD COMMUNICATION STATION KODIAK ALASKA, CALL SIGN- NOJ.  
THE FOLLOWING INFORMATION BELOW IS PROVIDED FOR YOUR VERIFICATION OF THE SIGNALS THAT YOU HEARD. WE ARE QUITE PROUD OF OUR SUPPORT CENTER AND COMMUNICATION STATION AND ITS COLORFUL HISTORY. COMMSTA KODIAKS MANY MISSIONS ARE - SEARCH AND RESCUE RESPONSE TO MARINERS IN TROUBLE, PROVIDING UPDATED WEATHER INFORMATION AND COMMUNICATIONS FROM AND TO THE MANY COAST GUARD UNITS UNDERWAY TO THEIR HOME UNITS. ALONG WITH MANY OTHER TASKS THE COMMUNICATIONS STATION IS MANNED 24 HOURS A DAY. THANKYOU FOR YOUR RECEPTION REPORT AS THEY ARE IN TURN PASSED OVER TO OUR TECHNICAL STAFF WHO DO TAKE THEM INTO CONSIDERATION.

FREQ- 5696 KHZ  
TIME- 0912Z UTC  
DATE- 05 JANUARY 1992  
MODE- VOICE / USB

YOU COPIED OUR PRIMARY AIR TO GROUND FREQUENCY WHERE WE KEEP TRACK OF OUR AIRCRAFT WORKING FISHERIES PATROLS OR ON A SEARCH AND RESCUE MISSION. SECONDARY FREQUENCY IS 8984 USB. THANKYOU FOR YOUR REPORT.

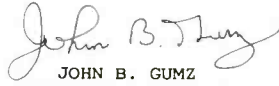
  
 JOHN B. GUMZ  
 RADIOMAN FIRST CLASS  
 UNITED STATES COAST GUARD



Here is the QSL letter received by Dan Grote, IL.

1533 Third message with 131515Z replaced by 131530Z  
 1542 End of message  
 1545 Tone followed by high-speed transmission  
 1547 Same as 1545  
 1555 End of monitoring  
 First time contributor Darren Gruber, FL says he has been involved in SWL'ing for about 1½ years. He uses a DX440 receiver

and enjoys listening to ute stations especially during shuttle launches. He added that he also likes those "weird" number stations.  
 John Dowlan, FL uses a Yaesu 757GXII and he has a LF Engineering L-400B active gain antenna.  
 Peter Stawicki, OK uses a Realistic DX440 with a snap-on longwire antenna.  
 Jerry Brookman, Alaska has a Kenwood R-5000 and for an antenna he has an Alpha-



**Delta DX-SWL Sloper.**

I want to share with readers a very unusual sequence of messages I copied. I cut into the transmission on 17479.8 kHz at 2214 UTC. It was a very strong CW signal and short messages of 3L groups were sent each minute until approximately 2220 when there were no more transmissions. Here is what a few of the messages looked like:

A2 DE D1 Y42 AAA MSG NR 90834 BK  
WMFZPS VAH OGX RZJK (Time 2214)  
A2, DE D1 Y42 AAA MSG NR 90835 BK  
GEL HOC IYR MJK TCE K (Time 2215)

These continued with the message number being one up each time and the text always just five 3L groups. Each message text was different. I don't have a clue as to who this is.

John Dowlan, FL forwarded a copy of an article from the *Tampa Tribune* of May 28, 1992. According to the article, MacDill Air Force Base will be home to a new Joint Intelligence Center which will be staffed by "specialists" from military and civilian "spy" agencies to work for the chiefs of the Central Command (Centcom) and the Special Operations Command (Socom). Perhaps we will be seeing some odd appearing communications from MacDill in the near future??

**UTE Intercepts. All Times UTC.**

- 201: Beacon APF, Naples, FL at 2009. (Dowland, FL)
- 203: Beacon SFQ, Suffolk, VA at 0407. (Vylasek, VA)
- 206: Beacon VNC, Venice, FL at 0046. (Dowlan, FL)
- 209: Beacon HOW, Homerville, GA at 0823. (Crabill, VA)
- 226: Beacon FAF, Ft. Eustis (Felker AAF), VA at 0347. (Vylasek, VA)
- 248: Beacon CPY, Camp Peary, VA at 0415. (Vylasek, VA)
- 254: Beacon FPY, Perry, FL at 1148. (Crabill, VA); Beacon LLW, Elizabeth City, NC at 0340. (Vylasek, VA)
- 263: Beacon JSO, Jacksonville, TX at 1604. (Low, TX)
- 269: Beacon AHX, Athens, TX at 1605. (Low, TX)
- 280: Beacon LJK, Ashland, VA at 1052. (Vylasek, VA)
- 286: Beacon OE, Dry Tortuga LS, FL at 1052. (Dowlan, FL)
- 296: Beacon XMK, Yellow River, AL at 1124. (Crabill, VA)
- 324: Beacon WI, Wachapreague Inlet, VA at 1845. (Vylasek, VA)
- 329: Beacon CH, Charleston, SC at 0340. (Dowlan, FL); Beacon OR, Norfolk, VA at 0429. (Vylasek, VA)
- 330: Beacon DDP, San Juan, PR at 0131. (Dowlan, FL)
- 332: Beacon RPF, Carthage, TX at 1843. (Low, TX); Beacon FIS, Key West, FL at 1146. (Dowlan, FL)
- 335: Beacon HP, Heath Point, PQ, Canada at 0511. (Vylasek, VA)
- 375: Beacon PJS, Newport News, VA at 2321. (Vylasek, VA)
- 388: Beacon MFV, Melfa, VA at 0441. (Vylasek, VA); Beacon JUG, Seagoville, FL at 1854. (Low, TX)
- 391: Beacon OCH, Nacodoches, TX at 1854. (Low, TX)
- 392: Beacon CF, Chesterfield, VA at 0443. (Vylasek, VA) This is ex-HYU. (Ed.)
- 396: Beacon APH, Ft. A. P. Hill, VA at 1751. (Vylasek, VA); Beacon CRS, Corsicana, TX at 1528. (Low, TX)
- 410: Beacon GG, Longview, TX at 1928. (Low, TX)
- 415: Beacon CBC, Cayman Brac. BWI at 0322. (Dowlan, FL)
- 426: Beacon IZS, Montezuma, GA at 0420. (Dowlan, FL)
- 428: Beacon EEJ, Sanford, NC at 0448. (Vylasek, VA)
- 432: Beacon MHP, Metter, GA at 0316. (Dowlan, FL)

TO: JERRY CODY

The Goddard Space Flight Center (GSFC) was named in honor of Dr. Robert H. Goddard, the pioneer of American Rocketry, who was also a radio amateur. GSFC is located in Prince Georges County, Maryland, Northeast of Washington, D.C. The center performs basic space research, is responsible for the development of unmanned satellites and manages/operates NASA's Global Tracking Network, including the Tracking Data Relay Satellite System (TDRSS). The Goddard Amateur Radio Club is an employee recreational organization. Please feel free to contact us whenever you visit the center.

The Solar Max Satellite, developed by GSFC and repaired during Shuttle flight 41C is depicted on the face of this card. This satellite typifies the center's commitment to scientific research, engineering expertise and spacecraft serviceability in the shuttle era.

Radio WA3NAN Confirms Your QSO/Reception as Follows:

DATE	TIME (GMT)	REPORT	FREQ.	MODE
MAR 30 92			14.295	

QSL via WA3NAN, Box 86, Greenbelt, Maryland, U.S.A. 20770

Color QSL By K7RPZ Print. Box 412, Rocky Point, NY 11778  
73. Carolyn OPR  
N3DON



*Jerry Cody, WA provided this copy of his QSL from the Goddard Space Flight Center.*

- 439: OST, Oostende, Belgium w/gale warnings in CW at 1720. (Boender, Netherlands)
- 442.5: FFB, Boulogne-Sur-Mer, France in CW at 0748 w/navigation warning. (new freq.). (Boender, Netherlands)
- 444.5: PCH, Scheveningen, Holland, w/tfc list at 2045; FFB, Boulogne-Sur-Mer, France wkg u/i vessel; DHS, Ruegen, Germany wkg u/i vessel at 2023. All in CW and a new freq for all. (Boender, Netherlands)
- 447: GNI, Nitton, England in CW at 1022 wkg u/i ship. (new freq.). (Boender, Netherlands)
- 448: LGQ, Rogaland, Norway in CW at 0805 w/tfc list. (new freq.). (Boender, Netherlands)
- 468: P3KK4, u/i vessel wkg DAN, Norddeich, Germany in CW at 2005.
- 512: ATIF, MV Jala Yamini wkg DAN in CW at 1858; PGJY, MV Norstar wkg DAN in CW at 1959. (Boender, Netherlands)
- 525: DAN, Norddeich, Germany w/wx (new freq) in CW at 2000. (Boender, Netherlands)
- 526: Beacon CYV, Camp Blanding, Stork, FL at 0326. (Dowlan, FL)
- 1921: LORAN station at 1138. (Low, TX)
- 2642: ICB, Genoa, Italy in USB at 1955. (Boender, Netherlands)
- 2670: CommSta Boston w/marine wx for Nantucket and Martha's Vineyard vicinity incl Cape Cod, Buzzard's Bay and Boston Harbor. Hrd at 0443. (Pihale, MN)
- 3090: Very odd-sounding signal, sounds like mating calls of whales, only w/ numerous echos. Signal consisted of tones of varying pitches, and tones would either rise or fall in pitch, echoing in rapid succession. One or more

of these signals would be present at any given time. End result sounded like whales or echoing seagulls. I've never heard anything like this before. (Sevart, APO, England)

3255: 5F grps in CW w/unusual characters and #'s at 2312. Dualing w/3687 kHz. Still going at 0226. Active next night at same time on both freqs. (Sevart, APO, England)

3336: CW stn rptng 6UNM and tone at 2340. Heard this type before on diff freq using 90NY. (Sevart, APO, England) For detailed look at such transmissions, see "A New Family of HF Radio Beacons" by William Orr which

**Abbreviations Used For Intercepts**

- AM Amplitude Modulation mode
- BC Broadcast
- CW Morse Code mode
- EE English
- GG German
- ID Identifier/location
- LSB Lower Sideband mode
- OM Male operator
- PP Portuguese
- SS Spanish
- tfc Traffic
- USB Upper Sideband mode
- w/ with
- wx Weather report/forecast
- YL Female operator
- 4F 4-figure coded groups (i.e. 5739)
- 5F 5-figure coded groups
- 5L 5-letter coded groups (i.e. IGRXJ)

appeared in the June 1986 POP'COMM. These signals continue to be heard. (Ed.)

**3350:** SLHFM "F" at 2314. (Sevart, APO, England)  
**3840:** YHF, YL/EE Mossad phonetics station in AM at 0132. (Sevart, APO, England)

**4010:** DFD21, YL/GG in USB at 2244 with msgs of 3/2F grps. Active about every half hour, uses both AM & USB. Rpts musical tones and YL/GG "DFD21" for 5 mins & goes into msgs. Musical tones are different every hour. (Sevart, APO, England)

**4261:** EBA, Madrid Naval, Spain in CW w/NAVAREA III warnings at 0044. One item of interest was research & salvage ops of a DC-9 that crashed in 1980 off coast of Italy. (Sevart, APO, England)

**4373:** USN FACSFAC "Giantkiller" wkg a/c at 0137. (Pihale, MN)

**4408:** VCS, Halifax CG, Canada w/offshore Newfoundland marine forecast. Also on 6513, 8785, 13113, 17251 kHz. (Pihale, MN); WGG, St. Louis on USB at 0035 wkg W69313, The Prosperity, which going down Mississippi river giving river conditions and load info. (Koch, IL)

**4423:** High Seas opr wkg cruise ship Festival w/pp 0010 to 0017 duplex hrd on 4431 kHz. (Gruber, FL); KMI, Dixon, CA in USB at 2340 w/pp w/Holiday. Ship was on 4131 kHz. (Koch, IL)

**4873:** IBA, Naples naval, Italy in USB w/rdo check to IBH, Vicenza naval stn at 2200. (Sevart, APO, England)

**4956.5:** KKN39, State Dept., w/CW mkr at 0032. (Hill, MI)

**4958:** 5F grps in MCW at 1945. Rptd grps. Ended w/BT BT 58 58 44 44, then series of U's which sounded more like "IT." (Sevart, APO, England)

**5015:** Papa November rptd w/musical tones at 1810 & 1829, then YL/GG w/msg in 3/2F grps. Was sending Papa Zulu at 1901 w/diff musical tones. This station active often. Duals w/11108 kHz. (Sevart, APO, England)

**5015:** MAC 50266 (C-141) w/pp at 2015 thru Ascension GCCS re stops in Bogota & La Paz. Enroute back to Charleston AFB. (Pihale, MN)

**5060:** Warbling jammer at 0136. Also on 5225, 5240, 5530, 5590, 5730, 6240, 6260, 6510 kHz. Jammers were moving up & down a few kHz. When one moved, others would be on a new freq also. (Sevart, APO, England)

**5130:** 5F grps in CW, similar to those on 3255 kHz. Also on 3687 kHz. Hrd at 2223. (Sevart, APO, England)

**5187:** 5F msg in CW w/unusual characters & #'s at 2015, still going at 2145. I hear a lot of these. (Sevart, APO, England)

**5301:** Czech press agency CETEKA w/VVV DE OLX in CW from 1950-1955. Then YL/Czech rptng 668 until 2000 when into 5F grps by YL. (Mason, England); Also hrd at 1757. At top of hour stopped & rptd 3F grp x6, then BT 011 011. Rptd till 1805 then into 5F grps. Does this very regularly, at the top of almost every hour. At other times, comes up in MCW and after VVV call has YL/Czech 5F msgs. Also appears on 4278, 6758 & 8141 kHz. (Sevart, APO, England)

**5306:** P, C, S, & D SLHF channel mkr at 0150. (Sevart, APO, England)

**5338:** NNN being sent in CW from 2000-2005, then YL/GG w/Gruppe 20 x2 and into 5F grps. Rptd next day on 4574 kHz at same time. (Mason, England)

**5417:** YL/SS w/5F grps on AM at 0511. (Margolis, IL)

**5500:** YL/EE rptng 288 oblique 00 from 2000-2005 then off. (Mason, England)

**5598:** ICAO NAT-A area HF atc network in USB w/jammer on freq at 0145. Not the first time I've hrd a jammer on this freq. (Sevart, APO, England)

**5680:** Plymouth Rescue, England in USB w/rescue comms to Rescue 51 & 190 doing airborne rescue ops off Atlantic Coast of France. Switched to 3023 kHz at 2053. At 2355, ops temporarily suspended due to darkness, to be resumed at first light under assumption ship had sank and to look for lifeboat. (Sevart, APO, England)

**5696:** Rescue 6001 wkg ComSta Boston for tfc in USB at 0203. (Hill, MI); ComSta Boston & Cape Cod Air wkg Rescue 1471 & 2130 re "Target acquisition" . . . "on scene til they get pumps started. Hrd at 2227. (Pihale, MN)

**5760:** YL/SS w/5F grps at 0609 in AM. Audio distorted. (Gruber, FL)

**6224:** Sailing yachts Southbound 2 & Lucky Dragon & several others chit-chat re wx & sea conditions. Most

QSL letter received by Ed Rausch, NJ



US Department  
of Transportation  
**Federal Aviation  
Administration**

Honolulu Flight Service Station  
4204 Diamond Head Road  
Honolulu, Hawaii 96816

March 10, 1992

Mr. Edward Rausch

Dear Mr. Rausch:

Thank you for your letter informing us of our broadcasts. We are pleased to know you were able to get our transmissions and hope you will continue to receive our broadcasts.

If you should visit our fair islands, we invite you to tour our facility which is located in the famous landmark -- Diamond Head Crater, where all of our broadcasts are done.

We provide you with the following information on our facility. If you wish more data, please write to us at the above address.

Voice broadcasts of meteorological information are made by this facility at "00" and "30" past each hour, broadcasting simultaneously on 2863, 6678, 8828, and 13282 kHz for the benefit of aircraft in flight within the Honolulu Flight Information Region.

Honolulu Radio has assumed broadcasting responsibilities from the Anchorage and Oakland radios with extended broadcast times of "25 to 35" and "55 to 05" past each hour.

Station Call	Honolulu Radio (voice)
Transmitter	Burnell THV (remote control)
Output	5 KW
Antenna	Doublet

The Honolulu Flight Service Station is a member of the Aeronautical Fixed Telecommunications Network (AFTN) which is sponsored by all nations to provide a worldwide system for the exchange of aeronautical communications.

"Aloha" from Hawaii.

Sincerely,

Francis G. Judd  
Air Traffic Manager  
Honolulu Flight Service Station

QSL letter received by Ed Rausch, NJ.

vessels in Caribbean but two were near the Azores. QSY to 12353 at 2350. (Rausch, NJ)

**6288:** IGJ43, Italian Navy at u/i location in CW at 2253 w/call. IGJ42 hrd on 4227 kHz at 2058. (Sevart, APO, England)

**6577:** New York ATC wkg Cubana flight 407 at 0601. (Gruber, FL)

**6604:** VFG, Gander Air in USB at 1922 w/wx. (Koch, IL)

**6683:** Andrews AFB wkg SAM's 573 & 574 for tfc & rdo checks in USB at 1320. (Hill, MI)

**6730:** Krasnodar, Russia VOLMET in USB at 2310. (Boender, Netherlands)

**6745:** Foghorn signal at 1906. Signal had wide bandwidth & could be hrd from 6737 to 6750 kHz. Very loud. (Sevart, APO, England)

**6760:** Neatishead wkg EIF and X0Z in USB at 1338. RAF tracking comms. (Sevart, APO, England)

**6761:** Poker 02 (KC-135R) w/pp to Rushmore Control at Ellsworth checking status of Tiger 31 (B-1B) on mission change at 0408; Poker 32 (KC-135) out of Ellsworth & Chill 21 (B-52H out of Minot) clg Skybird on ex-SAC S-391 at 0430; Tnbe 62 w/pp to Shocker Ct1 (B-1B) thru Microfilm. Shocker Ct1 is the CP at McConnell AFB, KS. Hrd at 1622. (Pihale, MN)

**6812:** SAM 200 (CX-20) wkg Andy w/pp to SAM command post & protocol staff. Hrd at 1114. (Pihale, MN)

**6817:** OM/EE w/Russian accent rptng 485 from 2100-2105. Then 316 316 42 42 and into 5F grps. Ended w/00000. AM mode. (Mason, England)

**6850:** YL/GG in USB at 2011 w/msg in 3/2F grps. (Sevart, APO, England)

**6934:** YL/EE in AM w/mgs in 3/2F grps at 0025. Ended at 0052. At 0032 YL announced what sounded like "Repeat" but I did not compare texts to see if they were same. (Stawicki, OK)

**7039:** SLHFM C & S at 0241. (Sevart, APO, England)

**7346:** Blaster, Bronco, Predator, Shotgun and Claymore in USB at 1938 participating in exercise w/radio checks. (Willmer, MI)

**7404:** Papa November, YL/GG in USB at 0035 w/msg in 3/2F grps. Dualing w/5015 kHz, but stn on 5105 was couple secs behind 7404. (Sevart, APO, England); YL/GG w/Oscar Kilo & electronic tones from 2000-2005. Then 319 319 90 Gruppen and into 5F grps. (Mason, England)

**7862:** YL/SS in AM at 0543 w/5F grps. (Gruber, FL)

**7888:** Morse stn rptng 224 at 1901. At 1905 sent 5F grps, then rptd msg and ended w/TTT. Slight QRM from

PFC/QSL

WDX1116 ANDEX 15237

This is to verify that I received your transmission from  
 Station: \_\_\_\_\_ at \_\_\_\_\_ hours  
 On frequency: \_\_\_\_\_ Using: \_\_\_\_\_ mode  
 On date: \_\_\_\_\_  
 Signed: \_\_\_\_\_

Harold Woering designed his PFC card and then had a printer make a quantity of the cards.

YL/EE numbers stn on 7887 kHz. (Sevart, APO, England)

**8140:** IGJ44, Italian Navy at u/i location in CW at 0608 w/call mkr. (Sevart, APO, England)

**8142:** Rapid CW dots from 2050-2055 foll by VVV DE OLX mkr in CW. Also sent on 5301 kHz but not parallel. At 2100 YL/Czech rptng 597 but now was in parallel w/5301 kHz. At 2105 into 5F grps. (Mason, England)

**8349:** UFB, Odessa, Ukraine w/UFB mkr in CW at 2023. (Boender, Netherlands)

**8500:** SLHFM "C" w/simulcast on 5306 & 7039 kHz. (Sevart, APO, England)

**8701:** UNM2, Klaipeda, Lithuania in CW at 2000 w/CQ mkr. (Boender, Netherlands)

**8728:** KMI, Dixon, CA wkg cruise ship Regal Princess (on 8204 kHz) in USB at 2335. (Koch, IL)

**8764:** NMN, CG Portsmouth, VA w/marine wx. Also on 4426 & 6501 at 0400. (Gruber, FL); Duplex comms between cutter Spar & Comsta Portsmouth. Latter wanted initiate 8 MHz RTTY t/c. Spar replied negative, they were on scene of SAR. Spar on 8240 kHz. Hrd at 0340. (Rausch, NJ)

**8791:** WOM, Pensucco, FL at 2205 w/pp w/Queen Elizabeth II in USB. (ship on 8267 kHz). (Koch, IL)

**8825:** New York ATC wkg American 66 at 0314. (Gruber, FL)

**8964:** AGA2, Hickham AFB in USB at 0115 wkg MAC 70029 for pp w/Hickam metro for wx update. (Koch, IL)

**8984:** CG San Juan in comms at 0030 w/Rescue 1712 & 6515. SAR & Medevac of injured crewmember on British sailing vessel. Injured party taken to Antigua. Also hrd Rescue 1712 wkg Barbuda Antigua air. (Rausch, NJ)

**8989:** Panther Delta on pp thru McClellan GCCS to Tiger Ops s/Sitrep on air base defense exercise at Davis Field w/KIA sniper. Threat on Bravo. Classified Secret-simulated. Said to later use HF primary 9650, secondary 9510 and later 5960 kHz. Hrd at 0332. (Pihale, MN)

**9011:** RAF Croughton in USB at 2230 w/comms fm a/c WL25 re wx conditions. (Koch, IL)

**9018:** Scrambled Air Force comms at 2220. (Low, TX)

**9032:** Architect, RAF wkg Ascot 1404 (RAF transport) w/flight info & selcal at 1721 in USB. (Sevart, APO, England)

**10051:** Gander radio w/aero wx for Canadian cities at 0025. (Gruber, FL)

**10213:** Grinder with r/c's w/Shadow Back and Sun Glass at 1601. (Willmer, MI)

**11176:** RS-803 (Navy C-9 enroute Scorpion Bay Island) wkg Ascension GCCS at 0419 indicated "We're surprised we got a hold of you 'cause we're out here over Montana." (Pihale, MN)

**11200:** RAF Volmet w/wx conditions at European airfields at 0410. (Pihale, MN)

**11214:** Canton Military ATC in USB at 1802. (Thompson, WV)

**11239:** CanForce 516 w/pp to Travis Metro thru McClellan GCCS at 0115. (Pihale, MN)

**11243:** Dexterity at 1530 w/pp re transportation for officer. (Low, TX)

**11246:** MAC68207 w/MacDill AFB in USB at 1320 for pp re wx info. (Koch, IL)

**11395:** New York ATC in USB at 2208. (Thompson, WV)

**11407:** Agar 25 via Cape Radio for pp to Aria Sim &

Aria Engineering at 1605 in USB. (Willmer, MI)

**11535:** India in USB net w/Iron Grip at 2320. Talk of QSY'ng to R6 but decided that R3 was clearest channel. Talk re putting up camouflage and India advised they would change receive antenna from whip to a 2259 and transmit on a 21B. Latter Missionary advised Butter that user had good crypto sync. (Willmer, MI)

**11740:** YL/SS in USB at 2012 w/5F grps. (Willmer, MI)

**11810:** Sensor in USB at 1520 w/rdocs w/Killgore, Killgore Alpha, Bravo, Charlie, Delta & Echo, Canary Seed, Canary Seed Alpha, Retail, Retail Alpha, Condor, Alley Cat Bravo, Alley Cat Delta, Dryden, and Freemason. (Willmer, MI)

**12214.8:** 5F grps (cut nbrs) in CW at 1207. Down w/AR AR AR SK SK SK at 1208. (Ed.)

**12224:** YL/GG rptng 205 205 205, 1 from 2130-2135 then 8852 26 8852 26 and into 5F grps. (Mason, England)

**12265:** U/i ship/shore phone in USB at 2247. (Thompson, WV)

**12856:** XSG, Shanghai, China in CW at 2050 w/CQ mkr. (Boender, Netherlands)

**13088:** B6G wkg 6CG w/long count & told 6CG to stand-by on this net. USB at 2048. (Hill, MI)

**13083:** WOO, Ocean Gate, NJ (Ch 1203) at 0308. (Low, TX)

**13167:** SPA, Gdynia, Poland in USB at 1838 wkg 3ELZ6, M/V Mita 1. (Boender, Netherlands)

**13241:** Bugle Boy w/code msg in USB at 2058. (Hill, MI)

**13312:** KZK73, u/i wkg KZP63, u/i in USB at 1010 w/testing of radio systems & phone patch systems. (Koch, IL)

**13456:** C32 running data test in USB w/MUM, u/i at 2204. QSY'd to F25 to avoid QRM w/UN morale pp net. (Willmer, MI)

**13457:** At 1542 Army 22258 (aka ANM902) wkg KCP63 (Denver, CO) requesting WHX20 (Seattle, WA) meet them on 4580 kHz. USB mode. (Willmer, MI)

**13671:** OM/RR rptng 472 472 472, 1 in AM from 2005-10. Then 756 756 361 361 & into a 361 group msg of 5F grps. Longest msg I've heard by this activity. Rptd at 2050 on 12226 kHz. (Mason, England)

**14245:** NMA, USCG Miami, FL wrkng Sea Harvest, a disabled vessel off S coast of Cuba. Vessel was a 65ft Shrimp boat, enroute to Grand Cayman and had been struck by lightning and had lost all Nav aids. Boat call sign was WY22403. WB4MDQ helped w/relays of comms. USB at 0335. (Parks, GA)

**14294:** WA3NAN w/STS-49 audio at 2355 w/successful retrieval of INTELSTAT-R at 0436 & redeployment of INTELSTAT. (Low, TX)

**14363:** OM/EE (British accent) w/5F grps at 2108. (Ed.)

**14422:** OM/RR rptng 648 648 648, 1 from 2100-2106. Then 257 257 30 30 and into 5F grps. (Mason, England)

**14506:** OM/RR w/645 645 645 000 at 2010. Off at 2015. (Mason, England)

**14513.5:** Beast Master, Hit Man, and Centurion in USB net at 2356. Net dealt w/circuit coordination w/LF Command 1 (SatCom), LF Command 3 (UHF), and Tac-1 for data mentioned. Centurion was also known as TECC afloat. (Willmer, MI)

**14556:** RIW, Khiva, Russian Navy in CW at 1450 wkg UXYR. (Boender, Netherlands)

**14654:** OM/RR w/102 102 102 1 from 2020-2025. Then 116 116 242 242 and into 5F grps. Rptd at 2058 on 13391 kHz. (Mason, England)

**14897:** USB comms between OM/SS & YL/SS at 1530 on Mystic Star network freq. They seemed to be checking reports because many numbers were mentioned. Location of Chihuahua, Mexico was mentioned for next day activities. (Low, TX) "Cambio" is used in SS comms as we use "Over" in EE comms. (Ed.)

**15105:** Albrook handling pp w/Howard metro for u/i stn. USB at 1304. (Koch, IL)

**15450:** Weak numbers stn. YL/EE w/msg in 3/2F grps at 1524. At 1530 heard "Repeat." Due bad conditions, I'm not sure if mode was full-carrier AM or reduced carrier AM, but definitely not SSB. Gone by 1550. (Low, TX)

**16085:** Warble jammer on top of u/i numbers bcst at 1438. (Ed.)

**16173.6:** YL/EE in USB at 1803 w/callup of 895 895 895 1-0 count then all rptd. (Ed.)

**16382:** USACE net in USB w/WUG (NCS Vicksburg, MS) wkg WUM (u/i) WUH (Omaha, NE), WUE4 (Huntington, WV), and WUI (Little Rock, AR) at 1512 on Channel 13. (Willmer, MI)

**16414:** YL/GG rptng Xray Alfa from 1500-05. Then 5F grps for addressee 331. (Mason, England)

**16807:** WLO, Mobile, AL w/Telex's at 2330. (Low, TX)

**16955:** UDH, Riga, Latvia w/ID in CW & ARQ phasing sig at 1403. (Margolis, IL)

**17103.2:** XSB, Shanghai, China in CW at 2012 w/CQ mkr. (Boender, Netherlands)

**17402.2:** AGL u/i w/VVV & CQ in CW at 1443 foll by 5L grps at 1444. (Margolis, IL)

**18200:** At 1500 RIW TA rptd in CW, then TA AWT rptd five times. At 1503 into 150 5F grps (cut nbrs) ANDUWRIGMT=1-0. Off at 1515 w/AR AR AR SK SK SK. (Johnson, NY)

**18525:** KKN50 in CW at 2057 w/QSX mkr. (Ed.)

**18726:** YL/EE w/3-2F grps on USB at 1441. (Margolis, IL)

**19086.5:** CLP1, MFA, Havana, Cuba w/mgs in SS in CW at 1504. (Margolis, IL)

**19087.3:** CLP1 w/CW callup at 1949 to Conakry, Guinea before RTTY xmsn. (Margolis, IL)

**19142.2:** Warbler jammer hrd on USB 1920-1936. (Margolis, IL)

**19637.5:** YL/SS w/numbers msg then rptd grps. (Pierce, MD)

**19707:** UXN, Arkhangelsk, RSFSR hrd at 1418. (Low, TX)

**20068:** OM/EE w/UN in Monrovia, Liberia hrd in simplex phone conversation on USB at 1359. Appeared to be an American. (Margolis, IL)

**20085.5:** Bulgarian Emb, Havana, Cuba in CW at 1840 after RTTY xmsn. (Margolis, IL)

**20090:** YL/EE at 1400 w/361 361 361 1-0 rptd in AM mode. At 1410 ten tones, count 225 x2 and into 3/2F grps. Also on 15833 kHz. (Johnson, NY)

**21845:** YL/EE counting 1-0 and 306 from 1800-1810. After ten times, count 122, and into 3/2F grps. (Mason, England)

**22378.2:** FFT, St. Lys, France at 1803. (Low, TX)

## Small in Size, BIG in Performance!

**4 + 4 STAR**

UPS SHIPPABLE

**Other Models & Sizes  
Available in 10 or 11 Meters**

MasterCard VISA DISCOVER

Call or send \$2.00 for Complete Catalog and Pricing of Antennas.

**JO GUNN Antennas**

Route 1 - Box 32C, Hwy. 82  
Ethelsville, AL 35461  
(205) 658-2229  
FAX: (205) 658-2259  
Hours: 10 am - 6 pm (CST)  
Monday - Friday

**DEALER INQUIRIES, PLEASE CALL**

### How To Obtain A Land Radio License For Maritime Communications

If your emergency rescue squad, emergency tow boat service, Civil Air Patrol, or Coast Guard Auxiliary unit is situated near navigable waters, you could qualify for a land radio station license in the maritime service. This would allow you to talk on marine VHF from shore to ship. It would also permit communication via marine single side-band from shore to ships at sea.

"In order to be eligible for a private coast station license, applicants must be regularly engaged in providing a service to meet the operational needs of vessels, where messages are limited to those pertaining to the purpose for which the ship is used," comments Marcus Stevens, Chief, Aviation & Marine Branch. This marine shore station license would be available to any applicant or organization who needs to talk from shore to boats out on the water on marine VHF or marine SSB. While it is common practice for the marine VHF handheld to be used on shore to talk back to boats, it's not legal without the land radio station license.

For emergency groups providing service or safety to vessels in local lakes, rivers, and the ocean, a shore station license will enhance your operation by providing direct communications between you and the boats in need.

There are countless VHF marine radio installations on land where operators routinely talk from their home, their business, and their vehicles to boats in the water. Without a license, this is absolutely illegal! And the FCC is stepping up their enforcement to these unauthorized stations—including those stations that may be used for emergency rescue purposes. If you're caught using a VHF or a marine SSB set on land without the land station license, you could be slapped ON THE SPOT with a fine of several thousand dollars for every day you are caught transmitting. The FCC means business on this one—so if you have a VHF or SSB station on land, better make it legal.

You will need 3 FCC forms to apply for the shore station license: FCC Form 503, \$70; FCC Form 155, Fee filing form; and FCC Form 753, \$35.

You may easily obtain these forms with a simple phone call to (202) 632-FORM (3676). This is a recorded message that will ask for your name, mailing address, and the specific forms you want sent to you. Be sure to have a touch-tone phone at hand when you make this call—their well-structured message requires you to push certain buttons—especially the # button—when you leave your name and address.

Radio Station License				UNITED STATES OF AMERICA FEDERAL COMMUNICATIONS COMMISSION			
Page 1 of 2							
RADIO SERVICE Maritime Mobile		FILE NUMBER 275-M-ML-25	IDENTIFIER W H D	CALL SIGN W H D			
CLASS OF STATION Limited High Seas, Regional, Local Coast		ISSUE DATE Feb. 22, 1985	EXPIRATION DATE Feb. 22, 1990				
LOCATION OF TRANSMITTER(S) AT A FIXED LOCATION STREET & NUMBER/AIRPORT		LOCATION OF AUTHORIZED CONTROL POINT(S) (APPLICABLE TO FIXED STATIONS ONLY):					
CITY	COUNTY	STATE		AREA AUTHORIZED FOR TEMPORARY LOCATIONS: Temporary unspecified fixed locations in the Southern California counties of San Diego, Orange, Los Angeles, Ventura, and Santa Barbara.			
LATITUDE	LONGITUDE						
PARTICULARS							
FREQUENCY	EMISSION DESIGNATOR		MAXIMUM TRANSMITTER POWER (WATTS)		SPECIAL PROVISION		
kHz	Carrier	Assigned	Day	Night			
2182.0	2183.4	2-BA3J	800	400			
2095.5	2097.9	"	150	150			
4125.0	4126.4	"	1000	1000			
4143.6	4145.0	"	"	"			
4419.4	4420.8	"	"	"			
6218.6	6220.0	"	"	"			
6221.6	6223.0	"	"	"			
8291.1	8292.5	"	"	"			
8294.2	8295.6	"	"	"			
12429.2	12430.6	"	"	"			
12432.3	12433.7	"	"	"			
12435.4	12436.8	"	"	"			
16587.1	16588.5	"	"	"			
16593.3	16594.7	"	"	"			
16590.2	16591.6	"	"	"			
Continued on Page 2.							
NUMBER OF TRANSMITTERS AUTHORIZED		SBS, SSSS, 2		PART OF FCC RULES GOVERNING TYPE ACCEPTANCE/OPERATIONS		81	
NAME AND ADDRESS OF LICENSEE				THIS LICENSE IS SUBJECT TO THE CONDITIONS ON THE REVERSE SIDE			
Gordon V. West 2414 College Dr. Costa Mesa, CA 92626				NOT TRANSFERABLE			
				FEDERAL COMMUNICATIONS COMMISSION			

Radio Station License				UNITED STATES OF AMERICA FEDERAL COMMUNICATIONS COMMISSION			
Page 2 of 2							
RADIO SERVICE Maritime Mobile		FILE NUMBER 275-M-ML-25	IDENTIFIER W H D	CALL SIGN W H D			
CLASS OF STATION Limited High Seas, Regional, Local Coast		ISSUE DATE Feb. 22, 1985	EXPIRATION DATE Feb. 22, 1990				
LOCATION OF TRANSMITTER(S) AT A FIXED LOCATION STREET & NUMBER/AIRPORT		LOCATION OF AUTHORIZED CONTROL POINT(S) (APPLICABLE TO FIXED STATIONS ONLY):					
CITY	COUNTY	STATE		AREA AUTHORIZED FOR TEMPORARY LOCATIONS: Temporary unspecified fixed locations in the Southern California counties of San Diego, Orange, Los Angeles, Ventura, and Santa Barbara.			
LATITUDE	LONGITUDE						
PARTICULARS							
FREQUENCY	EMISSION DESIGNATOR		MAXIMUM TRANSMITTER POWER (WATTS)		SPECIAL PROVISION		
kHz	Carrier	Assigned	Day	Night			
22124.0	22125.4	2-BA3J	1000	1000			
22130.2	22131.6	"	"	"			
MHz							
156.8	16F3		50				
156.45	16F3		50				
156.425	16F3		50				
157.025	16F3		50				
NUMBER OF TRANSMITTERS AUTHORIZED		2		PART OF FCC RULES GOVERNING TYPE ACCEPTANCE/OPERATIONS		81	
NAME AND ADDRESS OF LICENSEE				THIS LICENSE IS SUBJECT TO THE CONDITIONS ON THE REVERSE SIDE			
Gordon V. West 2414 College Dr. Costa Mesa, CA 92626				NOT TRANSFERABLE			
				FEDERAL COMMUNICATIONS COMMISSION			

The author's expired radio station license.

You may obtain up to 3 VHF marine channels for shore-to-ship operation. One of them must be Channel 16, one may be a non-commercial channel to talk to non-commercial boats, and the third could be a commercial channel to talk to your own commercial rescue operation.

If you plan to operate a marine single sideband, you may be assigned two working channels in the 2 MHz, 4 MHz, 6 MHz, 8 MHz, 12 MHz, 16 MHz, and 22 MHz bands. 2.182 MHz will always be assigned—this being the international distress and safety channel.

Emergency groups on the West Coast will also require frequency coordination for their VHF channel assignments. They would contact their local FCC field office for information about the local VHF marine frequency coordinating group. This group may also charge an additional \$100 for a channel search.

Follow the instructions carefully when filling out FCC Form 503. The FCC rules and regulations for the marine radio service is available from Fair Press Services, PO Box 19352, 20th Street Station, Washington, D.C. 20036-0352; (202) 463-7323. The Southern California Marine Radio Council may be reached at PO Box 1176, Wilmington, California 90744.

FCC Form 503 must be submitted along with FCC Form 155. Form 155 is the fee form, and your fee category for a marine post station license is "PBM", and is forwarded to the Federal Communications Commission, Marine Coast Service, PO Box 358265, Pittsburgh, Pennsylvania 15251-5265. The FCC Form 753 is your restricted radiotelephone operator permit, and that form is sent to the Federal Communications Commission, Restricted Permit, PO Box 358295, Pittsburgh, Pennsylvania 15251-5295. Don't forget your required FCC fees!

When your license arrives, it will give you specific authorization and your own call sign to transmit from shore to ships. For rescue squads operating vehicles, your license could also include operation from an unspecified location. This could allow you to transmit from a mobile-at-rest, or a portable unit.

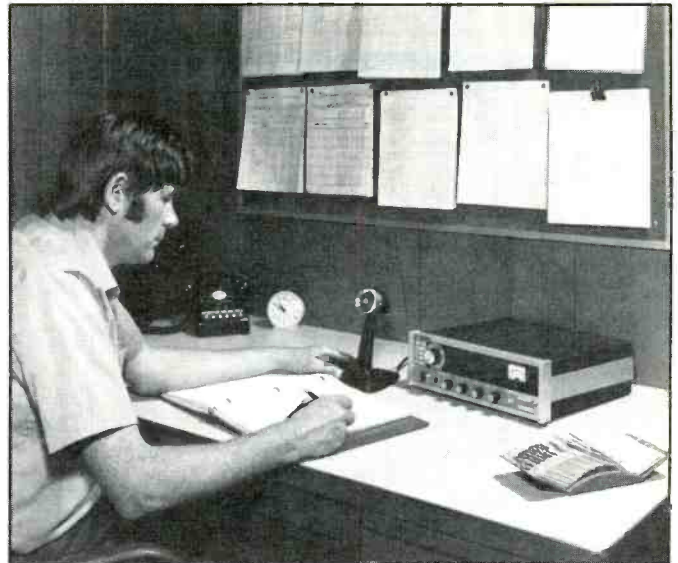

Private coast base station for shore to ship communications.

At no time is idle chit-chat permitted. You may only communicate essential marine radio traffic to these boats. You are also not allowed to talk between land stations, unless it is an emergency and two land stations are helping coordinate a rescue. You may also not talk from a handheld back to your land station when you are both on shore.

Your communications will assist the United States Coast Guard in their watch of VHF Channel 16, and the new calling channel, VHF Channel 9 (156.8 and 156.450 MHz).

If you think you qualify, get those forms, and license yourself for a land radio station license in the maritime service.

Approved by DMB 3060-0440 Expires 2/28/93		FEDERAL COMMUNICATIONS COMMISSION FEE PROCESSING FORM		FCC FORM 155 USE ONLY
Please read instructions on back of this form before completing. Section I MUST be completed. If you are applying for concurrent actions which require you to list more than one Fee Type Code, you must also complete Section II. This form must accompany all payments. Only one Fee Processing Form may be submitted per application or filing. Please type or print clearly. All required blocks must be completed or application/filing will be returned without action.				
<b>SECTION I</b>				
APPLICANT NAME (Last, first, middle initial)				
MAILING ADDRESS (Line 1) (Maximum 96 characters - refer to instruction (2) on reverse of form)				
MAILING ADDRESS (Line 2) (if required) (Maximum 96 characters)				
CITY				
STATE OR COUNTRY (if foreign address)		ZIP CODE	CALL SIGN	OTHER FCC IDENTIFIER
Enter in Column (A) the correct Fee Type Code for the service you are applying for. Fee Type Codes may be found in FCC Fee Filing Guides. Enter in Column (B) the Fee Multiple, if applicable. Enter in Column (C) the result obtained from multiplying the value of the Fee Type Code in Column (A) by the number entered in Column (B), if any.				
(A)	(B)	(C)	FOR FCC USE ONLY	
FEE TYPE CODE	FEE MULTIPLE (if required)	FEE DUE FOR FEE TYPE CODE IN COLUMN (A)		
(1)		\$		
<b>SECTION II</b> - To be used only when you are requesting concurrent actions which result in a requirement to list more than one Fee Type Code.				
(A)	(B)	(C)	FOR FCC USE ONLY	
FEE TYPE CODE	FEE MULTIPLE (if required)	FEE DUE FOR FEE TYPE CODE IN COLUMN (A)		
(2)		\$		
(3)		\$		
(4)		\$		
(5)		\$		
ADD ALL AMOUNTS SHOWN IN COLUMN C, LINES (1) THROUGH (5), AND ENTER THE TOTAL HERE. THIS AMOUNT SHOULD EQUAL YOUR ENCLOSED REMITTANCE.			FOR FCC USE ONLY	
TOTAL AMOUNT REMITTED WITH THIS APPLICATION (SEE LINE 5)				
\$				
This form has been authorized for reproduction. FCC Form 155 August 1991				

Here is the FCC's Form 155.

# Why buy a TNC?

## PC HF FAX + PC SWL \$179.00

### SPECIAL COMBINATION OFFER

For a limited time, if you order PC HF FAX \$99 (see our other ad in this issue), you can add our new and improved PC SWL 3.0 for \$80.00 instead of our regular low price of \$99.00.

PC SWL contains the hardware, software, instructions and frequency lists needed to allow you to receive a vast variety of digital broadcasts transmitted over shortwave radio. All you need is any IBM PC or compatible computer and an SSB shortwave receiver. The product consists of:

- Demodulator
- Digital Signal Processing Software
- 200 Page Tutorial Reference Manual
- World wide Utility Frequency List
- Tutorial Audio Cassette with Samples

PC SWL automatically decodes Morse code, Radio Teletype, FEC (forward error correcting code), SELCAL (selective calling transmissions), and NAVTEX.

PC SWL lets you tune in on world press services with up to the minute news, meteorological broadcasts, ham radio operators, coastal shore stations, aviation telex and much more digital action on the shortwave bands. Find all the utility station action you have been missing. PC SWL software uses the processor in your PC to do the work, why pay for another expensive box when a simple interface and your PC can do the job?

#### ADVANCED FEATURES:

- Tuning Oscilloscope
- Digital Waveform Presentations
- Auto Calibration and Code Recognition
- Continuously Tunable Filter Frequencies
- Variable Shift
- Adjustable CW Filter Sensitivity
- Unattended Capture and Printing
- Integrated Text Editor
- Integrated Log and Database
- Shell to DOS applications
- RTTY/NAVTEX Background Operation
- Seamless Integration with PC HF Facsimile

Call or write for our complete catalog of products. Visa & MasterCard welcome.

**Software Systems Consulting**  
615 S. El Camino Real, San Clemente, CA 92672  
Tel: (714) 498-5784 Fax: (714) 498-0568

CIRCLE 143 ON READER SERVICE CARD

# CLANDESTINE COMMUNIQUE

## WHAT'S NEW WITH THE CLANDESTINES

**W**RNO, New Orleans, is now carrying a program called National Vanguard Radio, a fascist, white supremacist effort very similar to the periodically active pirate, half clandestine Voice of Tomorrow. Indeed, according to pirate radio expert George Zeller, the announcer for National Vanguard Radio—identified as Kevin Alford Strong is almost certainly the same as heard on the Voice of Tomorrow. Zeller also believes both this program and Voice of Tomorrow are operated by a Nazi organization called the National Alliance. The broadcast airs at 0100-0130 on 7355, followed by a WRNO disclaimer. The address announced is Department R., PO Box 90, Hillsboro, WV 24946 although, so far, this has not produced any QSL's. This is the address for a company called National Vanguard Books, which deals in fascist/Nazi literature. They offer a catalog for \$1.

The anti-Colombian government station, Radio Patria Libre, continues to make frequency changes and adjustments—as well as maintain the mystery as to the location of its transmitter and its headquarters. Most recently, Patria Libre is being heard on 5850 or 5860. The area on and around 6300 is still in use. And the station is being widely heard on its 19 meter band frequency, generally 15050, though this also varies. Half hour broadcasts are scheduled at 0030 on 5850 and 15050 and at 1130 on 6300 and 15050. However, the broadcasts almost never start at the indicated times, or end a half hour later, so check the frequency five or ten minutes before the listed start time if you want to catch a sign on. The broadcasts, not surprisingly, are entirely in Spanish. We are still extremely interested in any clues readers may have or run across as to where the headquarters offices of Patria Libre and/or the ELN—the group believed to be operating the station—are located.

The Voice of Renamo, operated by the Mozambique National Resistance, claims to be broadcasting a program expressly for the armed forces of the Mozambique National Resistance, at 1045-1145 on 9860. We've seen no loggings for this, however.

A broadcast which backs ousted Haitian president Jean Baptiste Aristide is being aired via WHRI. It uses the name Radio 16 December (Radio Seize Decembre) and airs Monday through Friday at 2100-2300 on 17830 and Sundays from 1100-1300 on 9850, all in Creole. The program is being done via phone line from the Haitian Embassy in Washington, DC.

Iraqi Kurdistan Radio is scheduled at 0400-0525 and 1600-1725 using 4130. It reportedly is the mouthpiece of the Kurdistan So-



### THE PROGRAMME OF KOMALA FOR THE AUTONOMY OF KURDISTAN

Adopted by:

The Fourth Congress of the  
Kurdistan Organisation of the  
Communist Party of Iran (Komala)

February 1984

*The Kurdistan Communist Party of Iran is one of several groups supporting its own clandestine radio station.*

cialist Party and has been on the air since February or March of this year. Another Kurdistan clandestine, Voice of the People of Kurdistan is on from 1600-1830 on 3930, 6160 and 7055. At least one of the transmitters is a new, 10 kilowatt unit.

The Voice of Rebellious Iraq is reported on 8000, sometimes 8010 at 0330-0600, 1130-1400 and 1630-1900. This station supports the Shi'ite Supreme Assembly of the Islamic Revolution in Iraq, headed by Muhammad Baqir al-Hakim. The organization is supported by Iran.

It appears that Iraqi government radio has reinstated the "Holy Medina Radio" service which it aired during the Gulf War. The program is beamed to (and against) Saudi Arabia. It is scheduled from 0500-0900 and 1600-2000 on 11860.

The Voice of the Tiger has returned to shortwave, scheduled on weekends only, beginning at 0200 on 7030 upper sideband. The station is operated by the Liberation Forces of Tamil Eelam, seeking independence for their area of Sri Lanka.

Iran's Flag of Freedom Radio is being noted of late with an 0328 sign on (including an English ID) on 9250, 11470 and 15565. Another Iranian clandestine, Radio Azadi

(Liberty) is heard on 9400 and 15615 from 0230 sign on.

Radio Free Bougainville continues to be received by a number of monitors in North America. It's being heard on 3880, generally around 0900 and 1000, in English and Pidgin. The broadcasts announce an address of PO Box 1203, Honaira, Solomon Islands.

Palestinian broadcasts active at present include The Voice of Palestine, aired over Radio Algiers at 1700-1800 on 6145, 6160, 7145, 11715, 15215 and 17745. Some frequencies run for two hours, to 1900, others from 1800-1900. The Voice of Palestine in Damascus broadcasts on an irregular basis, via Radio Damascus, at 1630 to 1730 on 12085 and 15095. A third is the Voice of the Popular Revolution in Palestine which is on 17725 at 0330-0400 and 2130-2200.

That covers everything on hand for this month. We welcome your input to this column. That includes your loggings of clandestine stations and broadcasts, copies of QSL's, schedules or other material from stations or organizations operating them, background material on organizations, news clippings, monitored content and so on. Your help is appreciated!

Until next month—good hunting! ■

# ASLEEP...AWAY...ON-THE-JOB... DON'T MISS ANYTHING ON YOUR SCANNER

Exclusive! Monitor volume control is independent of recording volume.

Exclusive! VOX level light assures perfect adjustment.

Exclusive! Voice-tailored speaker system for listening clarity.

Exclusive! Delay time control adjusts to hold for reply messages.

Exclusive! Attractive molded high-impact cabinetry.

U.L. listed power supply included.

**BMI NITELLOGGER™**  
Automatic Tape Recorder Activator

## A permanent record even when you're not there!

"Before I installed NiteLogger I always seemed to miss the 'big stories'..." Now solve the biggest frustration of scanner enthusiasts: NiteLogger makes sure you'll hear it all, even if it happens at 3:47 a.m.!

## Foolproof operation...works every time!

"I've tried rigging up recorders before only to be frustrated... I was amazed how well NiteLogger worked." Balky relays, transistor switch polarities, hum pick-up, distortion, and more are all problems most scanner users have faced trying to match recorders to various model scanners. NiteLogger works with any scanner... every time... guaranteed! Just plug into the scanner's external speaker jack and any standard cassette recorder.

## VOX operation saves up to 7 days or more on a single C-90 cassette.

"I came back from vacation and could review the entire week's operation of my (police) department on tape." Depending upon the amount of activity on the channel, one cassette tape can hold many days — even weeks — of communications. And NiteLogger's exclusive VOX Delay control adjusts to minimize dead time on the tape, while still capturing reply messages without annoying tape start/stop noise.

## Hear while you record.

"What used to drive me crazy was that anytime the recorder was plugged into the scanner, the speaker was cut-off so I couldn't hear what was going on!" NiteLogger's built-in monitor speaker and Monitor Level control solves the problem. You control the volume from off to full on, independent of recording levels.

## Buy with absolute confidence.

In 1980 BMI introduced the first commercially available military time format clock independent of power lines... now used in hospitals, airports, police and fire departments worldwide. BMI also designed and produced the Mission Time Clock used on the Space Shuttle and the contingency timer for Mission Control. You can purchase BMI-engineered products with confidence!

## MONEY BACK GUARANTEE

If you're dissatisfied in any way with NiteLogger, just return it to us prepaid within 25 days for a prompt, courteous refund. For One Full Year NiteLogger is guaranteed to be free of defects in workmanship and materials. Simply send prepaid to BMI for warranty repair.

Introductory price just **\$69.95**  
(Plus \$4.50 shipping and handling).  
Complete with U.L. listed power supply, all cables, and easy step-by-step instructions.

# BMI

9445 Seven Mile Road  
Caledonia, WI 53108  
Phone: (414) 835-4299  
FAX: (414) 835-4298

CIRCLE 46 ON READER SERVICE CARD

©Copyright 1992, BMI, Inc.

## Beaming In

(from page 4)

Somewhere along the line, someone forgot that it's the responsibility of those wanting security to sufficiently upgrade their own technology to the point where it works. The primary responsibility for providing computer security can't be relegated to third parties on the basis of expecting they will offer security simply by ignoring the tempting and easily accessible data because they are told it is "illegal" to access, and because they should realize it's not nice to snoop.

That logic doesn't wash. That system of security can't work. Why should it work for those seeking security for their computerized data?

In the July ('92) issue of *U.S. Naval Institute Proceedings*, there was a feature on C4I by Robert David Steele, Assistant Chief of Staff (in charge of C4I—command, control, communications, computer, and intelligence) at Headquarters, U.S. Marine Corps. He stated, "the inherent danger in a necessary but risky strategy of reliance on commercial communications and computer equipment—to transmit much of our operational, logistics, personnel, and even intelligence information, around the globe—exacerbates the targeting-data and mapping shortfalls. The Marine Corps is off the limb and in free-fall when it comes to vulnerability to our C4I links . . . Our reliance on commercial satellites and ground switching stations leaves us wide open to total shutdown of our communications, and complete penetration of our administrative and logistics computer systems by any skilled hacker." He noted that this was the weakest, and most neglected, C4I link in the Marine Corps.

The man spelled it out very well. If commercial telecommunications landlines, satellites, and other facilities are to be relied upon, then they can be penetrated by skilled hackers.

And have you noticed that the majority of skilled hackers you learn about from the media are young adults or even teen-age hobbyists using home computers? Some of these hackers are benign and merely curious, others just like the challenge of seeing how many systems they can invade. Sure, there are also pranksters, plus a sprinkling of those who are truly malicious. The media seldom mentions the really dangerous professional computer security violators—those involved in industrial espionage, or who work for foreign governments, international drug cartels, terrorist groups, and organized crime. Nevertheless, benign or malevolent, hobbyist or professional, all who snoop through presumed secure computers have the potential to steal, modify, or destroy all kinds of data. That this can still so easily be accomplished seems rather astonishing at this point.

Underground BBS' offering information on these techniques are popular and known to all who wish to seek out the information.

The data in the computers that the hackers

are accused of accessing is just sitting there. It's tempting, tantalizing, juicy, ripe and practically crying out to be called up. To some amateurs and computer hobbyists, this is what amounts to an "attractive nuisance," similar to a swimming pool or a high tension electric tower. Attractive nuisances are potentially dangerous, but desirable and easily accessible things that require a fence or other security measures, lest the owner be declared negligent. Every individual, industry, and governmental entity is responsible when they create and maintain an attractive nuisance. They can post all of the "No Trespassing" signs they want, but they must still have safeguards such as fences. If their safeguards are violated, the owner of the attractive nuisance can still be considered to have been less than diligent in keeping out intruders. The intruder may be only minimally held responsible for getting through.

Somehow, though, the communications industry is unique in that it gets off the hook with being responsible for its many attractive nuisances. A "No Trespassing" sign is hung up, and intruders are considered to be in the wrong after that.

Common sense dictates that those wanting or needing real security have no right to fall back upon the convenient and relatively cheap low tech public access telecommunications systems, then cry "foul" when the security systems don't work for them. This includes all categories of governmental users, including the military. Maybe they'll have to hang up and use circuits closed to the public.

Those business firms, universities, governmental entities, and others who demand tight security but need to or elect to remain connected to the public access telecommunications system are going to have to get some better security advice, and more efficient security programs. Don't want to? Then, they can and will continue to have their data exploited by outsiders. They must tolerate it without complaining.

It's hard for me to have very much pity for multi-million dollar companies, or for the federal government, when I hear about their breached computer security. Not when I learn that it can be zapped by a hobbyist with a personal computer and a program that was downloaded from a BBS. I don't go quite so far as those hackers who claim that they're performing a public service by pointing out the security loopholes in computer security systems. The main service they are performing is in embarrassing those folks in charge of computer security. This is a service that is hardly appreciated, and is undoubtedly what has sparked their hilarious and hysterical media diversionary blitz and smokescreen on the evils of hackers.

My own policy on cellular and other comms has been that if you want privacy, it's solely your responsibility to assure that you take whatever steps are required to cause your system to be secure from outside interception. The responsibility can't be effectively dumped onto third parties either by legislation or by appeals to public ethics and good-

will. So let it also be with the data stored in computers.

I'm not an advocate for computer hackers or for hacking—quite obviously some of it has resulted in damage to and theft of data. But let's be at least a little fair about this ridiculous media overkill relating to amateur hackers. How about sharing some of the blame by shifting the complete focus off the hackers? Let's also see groups of these inept and impotent computer security experts dragged out in front of the tabloid TV cameras to own up to the public about their total inability to protect data about you and I, and on national defense, stored in and exchanged between public-access computers.

How about asking financial institutions, businesses, and governmental agencies to explain why they are so damned casual about protecting the data they are supposed to be holding in trust? And, forgetting about the hobbyists, let them admit to the potential threat to their stored data from terrorist groups, foreign governments, organized crime, and other high powered professional operations. Nobody wants to talk about any of these things. If the public ever learned of the real threats to stored data, they would no longer be too worried about amateur and hobbyist hackers.

Hobbyist hackers have been around for more than a decade. It's really time now to finally turn off the media's crocodile tears for the government and big companies that get their data rifled by an image of *Billy Whizbang* and his souped-up *Commodore 64*. If companies and agencies are so stupid and lazy that they still can't protect important and vital data, then what they deserve is our anger and derision, not public pity. The public, in turn, needs some real answers instead a lot of qarbage blaming it all on teen-age hackers.

Fifty years ago, young people reacted to attractive nuisances by swimming in a neighbor's pool while the people were on vacation. Or they stole the bell from the town church. Today, maybe they are into computer hacking instead. These are bright and creative people—let's not forget that. On the one hand, people complain about young people wrecking their brains on drugs and loud rock music. Hobbyist hackers are young people who aren't spending their money on drugs and rock CD's. Take your choice.

We aren't condoning computer hacking. Certainly the practice must be monitored and discouraged until the computer industry can find some people intelligent enough to devise valid security systems. But we should be mindful that in a few years, these young hackers are the bright people who will be on the cutting edge of developing future technologies. Instead of getting so bent out of shape about their undirected curiosity, let's think about trying to channel their talents and interests into more constructive directions! In all fairness, we can't allow the inept computer security industry make them sound too evil when, after all, hackers are (at worst) no more than a small part of the computer security problem. ■



# STEP UP YOUR SHORTWAVE SET UP.

## ISOLOOP 10-30 HF PORTABLE ANTENNA.

This is the one that gives you freedom of speech, whether you have to deal with restrictive covenants at home or in your apartment or condo, or if you are traveling in your boat, car, or RV. It features 150 watts, continuous coverage from 10 to 30 MHz, narrow bandwidth to suppress out-of-band signals. The IsoLoop antenna comes fully assembled with no mechanical joints. There is simply no better value in antennas!

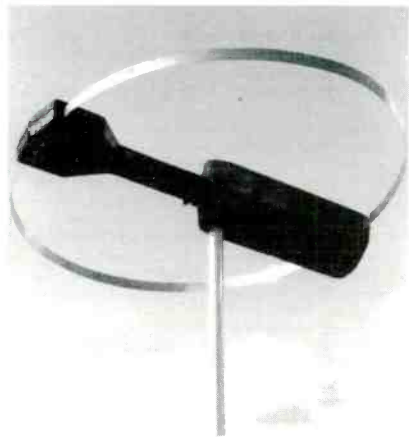

## PK-232MBX DIGITAL MULTI-MODE CONTROLLER.

It can receive eight different types of data signals, including Morse code, Baudot, ASCII, Time Division Multiplex (TDM), WEFAX, NAVTEX, Packet and AMTOR. Also featured is SIAM which automatically identifies many types of digital signals, excellent software support for PC compatibles, Macintosh and Commodore 64 & 128 computers. This unit is essential for the serious digital listener.

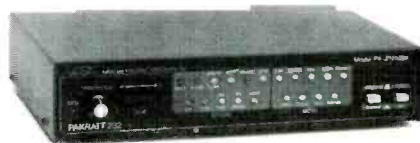

## AEA-FAX.

Here's the superior way to decode multi-level gray fax images received by your general coverage receiver. Featured is AEA's exclusive on-screen tuning scope that allows you to simultaneously tune and receive. There is also Autolist for unattended image capture and save-to-disk, "daisy-chain" external RS-232 input allowing AEA-FAX to share a COM port with PK-232 MBX, up to 16 gray levels (VGA), support for EGA, CGA and Hercules formats. AEA-FAX prints to HP LaserJet or Epson compatible printers and includes hardware demodulator, 3 1/2" and 5 1/4" software disks plus a comprehensive instruction manual. AEA-FAX is a must for your set-up!

*To connect with the AEA dealer nearest you or for product sheets, call (800) 432-8873.*



*Connect with us*

**Advanced Electronic Applications, Inc.**

PO Box C2160, 2006 - 196th St. SW, Lynnwood, WA 98036 Sales: (206) 774-5554

# COMMUNICATIONS SHOP

**Advertising Rates:** POP'COMM subscribers are entitled to one FREE 30-word, non-commercial classified ad per year. Enclose subscription name label with ad copy. For those people not in the previously mentioned group, non-commercial ads are 30 cents per word, including abbreviations and addresses; minimum charge \$6.00 per issue. Ads from firms offering commercial products or services are \$1.00 per word; minimum charge \$20.00 per issue. Boldface words are \$1.20 each (specify which words). Leading key words set in all caps at no additional charge. All ads must be prepaid in full at time of insertion; a 5% discount is offered for prepaid 6 time insertions. All ads must be typewritten double spaced.

**Approval:** All ad copy is subject to Publisher's approval and may be modified to eliminate references to equipment and practices which are either illegal or otherwise not within the spirit or coverage scope of the magazine.

**Closing Date:** The 10th day in the third month preceding date of publication. Because the advertisers and equipment contained in Communications Shop have not been investigated, the Publisher of Popular Communications cannot vouch for the merchandise listed therein. Direct all correspondence and ad copy to: PC Communications Shop, 76 N. Broadway, Hicksville, NY 11801.

**WOW! UNDERSTANDING & REPAIRING CB RADIOS** by Lou Franklin. Giant 380-page technical book picks up where THE "SCREWDRIVER EXPERTS" GUIDE leaves off. Includes circuit descriptions and troubleshooting guide for virtually all CB radios: 23 and 40-channel, crystal and PLL, solid-state and tube, AM, FM, SSB, CW, American, British and export models. Covers test equipment, transistor basics, synthesizers, receivers, transmitters, power supplies, T/R switching, antennas, interference, parts and accessory sources. Over 350 illustrations plus huge subject index. Moneyback Guarantee! Only \$29.95 plus \$3.50 U.S. & Canadian Air Mail. VISA/MC accepted. Free catalog of unique CB books, plans, and modification kits with order. Catalog only, \$2. CBC INTERNATIONAL INC., BOX 31500PC, PHOENIX, AZ 85046. Thousands of satisfied customers since 1976.

**Radio Newyork International!** Listen for us every Sunday night at 9 pm (Eastern), 8 pm (Central), 6 pm (Pacific) over WWCR, 7435 kHz. All of your favorites: Al Weiner, Steve Cole, Pirate Joe, John P. Lightning, & more! Live call-in at 800-326-2859. QSL's (send SASE) from RNI, 14 Prospect Ave., Yonkers, NY 10705. Spend your Sunday nights with RNI!

**CB RADIO HACKER'S GUIDE!** Big 151 page book: pictorials, diagrams, text. New! Complete guide to peaking, tweaking, & modifying 200+ CB radios for enhanced performance & more features. Which screws to turn, which wires to cut, AM & SSB radios, Cobra, Courier, GE, Midland, Radio Shack Realistic, SBE, Sears, Uniden/President. Get the most from your CB radio & operations. Only \$18.95, plus \$3.50 for UPS (sent 1st Class to AK, HI, PR, GU, military, & Canada). NY State residents add \$1.91 tax. Order from CRB Research Books, Inc., PO Box 56, Commack, NY 11825.

**SCANNER MODIFICATION HANDBOOK VOL.1** by Bill Cheek ("Doctor Rigormortis"). New 160-page book. More than 20 performance improvement modifications. Simple step-by-step instructions, many photos. Primarily PRO-2004 & PRO-2005, some for PRO-34, BC-200/205XLT, BC-705XLT, BC-705XLT. Restore blocked out bands, speed up scanning rate, disable "beep," increase number of channels, improve squelch action, add an S-meter, interface with shortwave receivers, etc. Make the PRO-2004 & 2005 into a 6,400 channel scanner, put 3,200 channels into the PRO-34! Plus, cellular frequency charts, antenna info & mods, inside info on frequency management, operating hints, emergency power supplies, scanners & the law. Lots more! Only \$17.95, plus \$3.50 shipping to addresses in USA/Canada. Residents of NY State add \$1.83 tax. **Big 220 page VOL.2** with 18 more mods for PRO-2004/5/6, PRO-34, PRO-2022, BC-760/950XL, BC-200/205XL, now available, \$17.95 plus \$3.50 shipping. NY state residents include \$1.83 tax. If both books ordered at the same time, send only \$4.50 shipping. Order from CRB Research Books, Inc., PO Box 56, Commack, NY 11825.

**TUNE In On Telephone Calls.** Tom Kneitel's new 160-page book. Everything you need to know to effectively use a scanner and communications receiver to eavesdrop on private telephone calls from homes, offices, cars, ships, aircraft, trains. Explanatory text, photos, extensive listings section covers USA/Canada on HF, VHF, UHF, and above; thousands of locations, frequency assignments. Explains equipment, best techniques, laws regarding monitoring cellular, cordless, ship/shore, high seas, Air Force 1, airliners. 1-way paging, more. Only \$12.95 (plus \$3.50 postage to USA/Canada/APO/FPO) from CRB Research, Box 56, Commack, NY 11825. NY residents add \$1.40 sales tax. Dealer inquiries invited.

**AR-1000XLT** with cellular - \$395, AR-2500 w/ cellular - \$425, AR-3000A w/ cellular - \$959, BC-200XLT - \$249, BC-760XLT - \$279, BC-855XLT - \$209, RCI-2950 - \$295, RCI-2990 Base, CALL!! Scanners, CB's, antennas, books, shortwaves, new and used gear. Free UPS shipping!! Picture price sheets - \$1.25. GALAXY, Box 1202, Akron, Ohio 44039 (216) 376-2402, 9-5PM EST.

**SONY ICF-PRO80**—Handheld receiver, 150 kHz-108 MHz & 115 MHz-223 MHz, manual, etc. \$225. Geoff phone/fax (713) 337-5769.

**VIDEO SYNC GENERATOR** Restores Horizontal & Vertical sync lines from distorted analogue video formats. For information on completed units & pricing Write: R C Distributing, Box 552, South Bend, IN 46624.

**COMMUNICATION AT ITS BEST.** AR-900 \$219, AR-1000XC \$399, AR-2500 \$439, AR-3000A \$969, BC-200XLT \$249. Low-est Prices Guaranteed on AOR Radios. We carry a variety of CB's, Scanners, Radar Detectors and more. **FREE SHIPPING!!** Visa/MC, Amex, Turbo Electronics, 366 N. Broadway, Suite 310, Jericho, NY 11753. Questions and Catalogs: (516) 938-1946. Orders: 1-800-33-Turbo.

**CELLULAR HACKERS BIBLE.** Theory - Hacks - Modifications - \$53.95. TELECODE, PO Box 6426-PC, Yuma, AZ 85366-6426

**CABLE TEST CHIPS** Scientific-Atlanta 8550-321, 8500-310, 311, 320, 321 (specify) \$33.95, 8580-338 - \$69.95, 8570/8590 - \$79.95, ZENITH ZF-1 - \$33.95, STARCOM 6 - \$33.95, STARCOM 7 - \$49.95, TOCOM 5503/07 VIP - \$33.95 TELECODE, PO Box 6426-PC, Yuma, AZ 85366-6426

**KENWOOD & ICOM Service Bulletins.** 175+ pages covering all models - \$39.95 Catalog \$3.00 CODs 602-782-2316/FAX 602-343-2141. TELECODE, Box 6426-PC, Yuma, AZ 85366-6426

**VIDEOCIPHER II/Satellite/Scanner/Cable/Amateur/Cellular/Repair Manuals, Modification Books & Software.** Catalog - \$3.00 TELECODE, PO Box 6426-PC, Yuma, AZ 85366-6426

**JOBS** in Electronics. Companies are still hiring for positions in US and Overseas. For a listing of 400 companies plus resume guide, send \$10.00 to Benthos-PC, POB 23336, Barrigada, GU, 96921.

**PRO-2004/5/6 OWNERS:** Search-and-Store finds unknown frequencies automatically. Internal no-holes installation. Keyboard control - Wired-tested-postpaid: Ten channel \$24.95 - Selectable to 255 channels \$44.95. US checks or MO. SASE for information. Key Research, POB 846P, Cary, NC 27511-0846

**WORLD MAP DIRECTORY.** There you are at 2am about to sign off when all of a sudden a signal comes skipping in from Radio Free Tonga. The WMD will not only help you locate Tonga, it will tell you where you can get maps for Tonga or anyplace else in the world. Call MapLink: (805) 965-4402.

**SCANNERS** CBs, Antennas, Marine, 2way, accessories, Handy-Talkies. Write for free brochure. HPR, Box 19224C, Denver, CO 80219.

**SHOCKING MANUALS!!** Survival Electronics, Computers, Telephones, Energy, Weapons, Financial, Medical, 100+ Plus Special Projects, Technical Research Services. Confidentiality Guaranteed! Send \$3 for catalogs. By John Williams, (CBS "60 MINUTES" fame). Since 1971. CONSUMERTRONICS, 2011 Crescent Dr., PO Drawer 537, Alamogordo, NM 88310

**COMMODORE 64 HAM PROGRAMS**—8 disk sides over 200 Ham programs—\$16.95, 29¢ stamp gets unusual software catalog of Utilities, Games, Adult and British Disks. Home-Spun Software, Box 1064-PC, Estero, FL 33928

**BIG 7th Edition: Top Secret Registry of Government Radio Frequencies** by Tom Kneitel. Grown to gigantic 240 pages! 1000's of new listings, frequencies, stations for all scanner owners, nationwide. Includes: FBI, DEA, Customs, Secret Service, FCC, Immigration, Border Patrol, U.S. Attorney, ATF, Treasury, Fed. Prisons, U.S. Marshal, CIA, Postal Service, NSA, NORAD, USAF, USN, Army, USMC, FAA, NASA, DOE, NRC, FEMA, Dept. Agriculture, National Parks, USCG, EPA, DOT, V.A., UHF aero (225 to 400 MHz) listings, bugs & surveillance freqs, agents' lingo, codes, many more agencies. Lots more info! Expanded Canadian listings. Only \$19.95, plus \$3.50 postage to N. American addresses. NY State residents add \$2.00 sales tax. Order now from CRB Research Books, P.O. Box 56, Commack, NY 11825. Dealer Inquiries Invited.

**RADIO MONITORS NEWSLETTER OF MARYLAND FOR THE SERIOUS SHORTWAVE AND SCANNER LISTENERS.** PO Box 394, Hampstead, MD 21074. For a one year subscription: \$15.00. Sample copy: one dollar.

**TOMCAT'S BIG CB HANDBOOK**, by Tom Kneitel. Just published, 221 large pages, fully illustrated. Complete guide to worldwide AM, SSB, Freeband, 27 MHz operations. Everything they never told you (legal & otherwise) from world's leading CB authority. Only \$13.95 (plus \$3.50 postage to North America) from CRB Research Books, Inc., P.O. Box 56, Commack, NY 11825. (NY residents add \$1.49 sales tax). Dealer inquiries invited.

**COMMUNICATION AT ITS BEST** AR-1000XC \$399, AR-2500 \$469, AR-3000 \$969, AT5803A \$195. We sell a variety of CB's, Scanners, Radar Detectors, Caller ID's and more. **Free Shipping** Visa/MC/Diners, Turbo Electronics, PO Box 8034, Hicksville, NY 11802. Questions and Catalogs: (516) 938-1946. Orders 1-800-33TURBO.

**THE NEW YORK MONITOR NEWSLETTER**—a monthly Newsletter that provides CB'ers with the latest up-to-the-minute Technical information—Radio Repair and Modification—Phase Lock Loop (PLL) Circuit/Expander—**2 YEAR COURSE IN ELECTRONIC COMMUNICATION** and much much more!! \$24 per year mail to **LORD/WYATT COMMUNICATIONS, P.O. Box 030128PCD, Brooklyn, NY 11203-0001.**

**CW? NO PROBLEM.** You can increase your speed, no matter how many times you've failed before. **Results guaranteed** when you follow the instructions. PASS Publishing's **CW Mental-Block Buster** program helps you **explode mental blocks** that hold you back. Based on 40 years of research, the **CW Mental-Block Buster** uses guided meditation, dynamic visualizations, and powerful affirmations to blast through mental blocks. **You can do code!** That means new bands, more contacts, more fun! (This is not a CW practice tape.) The **CW Mental-Block Buster** audio cassette and practice booklet are only \$25.95 ppd, in the US (NY residents add \$2.08 sales tax). (Quantity discounts available for classes.) PASS Publishing, P.O. Box 570, Stony Brook, NY 11790. VISA, MC, COD: 516-584-8164. FAX: 516-584-9409.

**MORSE code got you down?** Why let a mental block stand between you and upgrading? Use PASS Publishing's **CW Mental-Block Buster** to blast through those barriers. Just follow the instructions for 30 days—**Results Guaranteed!** Based on 40 years of research, the **CW Mental-Block Buster** uses guided meditation, dynamic visualizations, and powerful affirmations to blast through mental blocks. **You can do code!** That means new bands, more contacts, more fun! (This is not a CW practice tape.) The **CW Mental-Block Buster** audio cassette and practice booklet are only \$25.95 ppd, in the US (NY residents add \$2.08 sales tax). (Quantity discounts available for classes.) PASS Publishing, P.O. Box 570, Stony Brook, NY 11790. VISA, MC, COD: 516-584-8164. FAX: 516-584-9409.

**CW Lite** is the **easiest** Morse code training method in the world, bar none! And it is the **fastest**, too. Just close your eyes and relax. This powerful **hypnosis cassette tape** does the rest. **Subliminals** speed you along! Only \$15.95 ppd in US (NY residents add \$1.28 tax). Order today! **PASS Publishing**, Box 570, Stony Brook, NY 11790. VISA, MC, COD: 516-584-8164. FAX: 516-584-9409.

**WORLD'S MOST UNUSUAL** Communications Books! A large selection of outstanding titles covering scanners, "confidential" frequency registries, bugging, wire tapping, electronic surveillance, covert communications, computers, espionage, monitoring, and more! New titles being added constantly! Ask for our big FREE catalog. CRB Research, Box 56-PC, Commack, NY 11825.

**STOP!** Buy at/ or below wholesale—CBs, Amateur, Shortwave, exports, linears, directly from manufacturers/distributors. **LORD WYATT COMMUNICATIONS DIRECTORY** lists over 250 product sources—send \$19.95 to **LORD WYATT COMMUNICATIONS**, PO Box 030128PDN, Brooklyn, NY 11203-0001.

**SHORTWAVE PARADISE BBS** now has the new Fall/Winter schedules available. Call our computer line now at 1-305-524-1035.



Scanner World, USA

"The Largest Dealer of Scanners in the World"

# SCANNER WORLD, USA

10 New Scotland Ave., Albany, NY 12208 • 518/436-9606

## SCANNER WORLD EXCLUSIVE

### UNIDEN BEARCAT BC205XLT

**\$239.99** (\$8.00 shipping)

Digital programmable 200 channel hand held scanner with raised button keyboard for easy programming of the following frequency ranges: 29-54 MHz, 118-174 MHz, 406-512 MHz, 806-956 MHz. \* Features include: Scan delay, memory backup, key pad lock, sidelit liquid crystal display, channel lockout, 10 twenty channel banks, direct channel access, automatic search, full one year factory warranty, 10 priority channels, Ni-Cad battery pack, AC adapter/charger, flexible rubber antenna carry case are all included. Size is 2-11/16" Wx1-3/8" Dx7-1/2" high. (Optional extended 2 yr. warranty \$29.99, 3 yr. extended warranty \$39.99.) (\* Excludes Cellular)  
#CC-008 Heavy Duty Leather Carry Case \$27.99

### RELM RH-256NB HIGH BAND TWO-WAY RADIO



**SPECIAL PACKAGE DEAL \$339.99**

(Plus \$9.00 Shipping Each)

16 channel digital readout two-way radio. Covers high band frequency range of 148-162 MHz without retuning. Perfect two-way radio for ambulance, police, fire, tow trucks, taxis, commercial companies who use this band. Features include CTCSS tones built-in, priority, 25 watts output, channel scanning, back lighted keyboard, message light, time out timer, scan delay, external speaker jack. Size is 2 3/4" Hx6 1/4" Wx10 1/4" D.

**SPECIAL PACKAGE DEAL** includes RH-256NB, mobile microphone, 1/4 wave body mount antenna, mobile mounting bracket and mobile power cord all for the low price of \$339.99

## SPECIAL!!

LOWEST PRICE EVER FOR A PROGRAMMABLE SCANNER



**SR-901**  
AVAILABLE ONLY FROM SCANNER WORLD

**ONLY! \$74.99** Each  
(Plus \$6.00 Shipping Each)  
**\$69.99** (2 or more)

Features include: 10 programmable channels, one touch memory programming, external speaker jack, 29-54 MHz, 136-174 MHz, 400-512 MHz, squelch, lockout, full frequency digital readout, AC or DC operation, retains memory up to 3 days without power, scan button. Includes AC adapter, telescopic antenna, and complete operating instructions. Size: 7 1/4" W x 2" H x 7 1/4" D. One year factory warranty. (Optional mobile cigarette lighter cord #901MPC \$4.99)

### UNIDEN MR 8100



**SPECIAL SALE PRICE \$289.99**  
ONLY (\$10.00 Shipping Each)

100 channel digital programmable mobile scanner, turbo scan up to 100 channels per second, lockout, priority, built-in automatic 2 second delay, dimmer control, back lighted keyboard, track tuning, direct programming of frequencies from front keyboard plus you can also program MR 8100 from your IBM compatible PC computer with software and cables included with scanner from Scanner World. Frequency coverage: 29-54 MHz, 118-174 MHz, 406-174 MHz, 406-512 MHz, 806-956 MHz. Dimensions: 7 9/16" W x 5 8/16" H x 1 9/16" D. Earphone jack, BNC antenna jack, DC power cord, mobile mounting bracket, internal memory backup, bank scanning; 10 banks of 10 channels in any combination.

## RADIO SCANNERS

BEARCAT BC55XLT	108.99	(7.00)
BEARCAT BC70XLT	144.99	(7.00)
BEARCAT BC100XLT	159.99	(7.00)
BEARCAT BC140	94.99	(7.00)
BEARCAT BC142XL	94.99	(7.00)
BEARCAT BC147XL	99.99	(7.00)
BEARCAT BC200XLT	279.99	(7.00)
BEARCAT BC205XLT	239.99	(8.00)
BEARCAT BC310A	85.99	(7.00)
BEARCAT BC330A	109.99	(7.00)
BEARCAT BC400XLT	99.99	(7.00)
BEARCAT BC560XLT	109.99	(7.00)
BEARCAT BC760XLT	269.99	(7.00)
BEARCAT BC800XLT	249.99	(8.00)
BEARCAT BC855XLT	186.99	(8.00)
BEARCAT BC950XLT	249.99	(7.00)
COBRA SR901	74.99	(6.00)

MIDLAND CB Radios	In Stock
COBRA CB Radios	In Stock
UNIDEN CB Radios	In Stock
Two-Way Radio Batteries	In Stock
Scanner Antennas	In Stock
Power Supplies	In Stock

RELM RH606B	414.99	(9.00)
RELM UC202 (2 or more)	129.99	(6.00)

## SCANNER ACCESSORIES

BCAD70	14.99	BP4	24.99
BCAD100	14.99	BP55	16.99
BCAD140	14.99	MA917	24.99
BCAD 580	16.99	MA518	14.99
BC003	7.99	ESP25	16.99
BC002	59.99	GRE8002	79.99
PS001	12.99	GRE-HH	54.99
UA502A	12.99	GRE9001	89.99
BP205/200	34.99	GRE 3001	62.99
BP70	16.99	FBE	5.99
VC001	12.99	FBW	5.99

★ ALL MERCHANDISE NEW, IN FACTORY SEALED CARTONS

## BOOKS

Covert Intelligence	8.95
Air Scan Directory	14.99
Betty Bearcat	5.99
Top Secret (7th)	15.99
Covert Techniques	9.95
Tomcat's Big CB	13.95
World Radio	18.99
Survival Directory	6.95
Rail Scan	7.95
Police Call	8.69
Scanner Modification	17.99

**ORDERING INFORMATION:** Call (518) 436-9606 to place orders or mail orders to Scanner World, USA, 10 New Scotland Ave., Albany, N.Y. 12208. Orders will be shipped within 24 hours by United Parcel Service if order is accompanied by MasterCard, Visa, cashier's check, money order, COD (COD shipped by United Parcel Service will be cash or money order only). (If a COD package is refused, customer will be billed for shipping and COD charges.) Mail orders with personal or business checks enclosed will be held 4 weeks for bank clearance. Prices, specifications, and terms subject to change without prior notice. If items are out of stock we will backorder and notify you of delivery date. All shipments are F.O.B. Scanner World® warehouse in Albany, N.Y. We are not responsible for typographical errors. All merchandise carries full manufacturer's warranty. Bid proposals and purchase orders accepted from government agencies only. Free full line catalog mailed 4 times per year. Merchandise delivered in New York State add 7% sales tax. No returns accepted after 7 days of merchandise receipt. \* Add (\$) per item, and \$3.50\* for all accessories ordered at same time. COD orders will be charged an additional \$4.95 per package. Full insurance is included in shipping charges. All orders are shipped by United Parcel Service to street address only. (No P.O. Box). Shipping charges are for continental USA only. All others ask for quote on shipping charge.

### UNIDEN BEARCAT BC-400XLT



**\$99.99**

(\$7.00 shipping)

Our best selling mobile scanner, 16 channel, AC/DC programmable, digital, AC/DC cords, telescopic antenna, mobile mounting bracket, weather search, priority, 29-54 MHz, 136-174 MHz, 406-512 MHz, external speaker and antenna jack.

### BEARCAT BC-100XLT

100 Channel Digital Programmable Hand-Held Scanner

**\$159.99**

(\$7.00 shipping)



Our best price ever on a full featured complete package hand-held scanner. Manufactured by Uniden. Features include 11 bands of weather, aircraft, public service, trains, marine, plus more (29-54 MHz, 118-174 MHz, 406-512 MHz), 10 channel banks, 10 priority channels, lighted LCD display, earphone jack, channel lockout, AC/DC operation, scans 15 channels per second, track tuning. Special package deal includes following accessories: AC adapter/charger, rechargeable Ni-Cad battery pack, flexible rubber antenna, carry case.

### BEARCAT BC-147XLT 16 CHANNEL BASE SCANNER

**\$99.99** (\$7.00 Shipping)

Programmable, digital, AC/DC operation. Frequency coverage 29-54 MHz, 136-174 MHz, 406-512 MHz. Weather button, priority, lockout button, squelch includes AC adapter, telescopic antenna.

### BEARCAT BC-142XL 10 CHANNEL BASE SCANNER

**SPECIAL PRICE: \$79.99** (\$7.00 shipping)

10 channel version of BC-147XLT

### UNIDEN BEARCAT BC 800XLT

DIGITAL BASE SCANNER



**\$249.99** (\$8.00 Shipping)

Receive police, fire, ambulance, cordless phones, marine, trains, weather, ham, stock cars, public service plus much more. Frequency coverage 29-54 MHz, 118-174 MHz, 406-512 MHz, 806-912 MHz (continuous). 40 channels, AC/DC operation, digital programmable, memory backup requires 2 AA batteries (not included), telescopic antenna included, AC power cord included, external speaker jack, external antenna jack. Dimensions: 9 1/4" D x 4 1/2" H x 12 1/2" W. Channel lockout, direct channel access, scan delay, priority, digital display, auto weather button, automatic search, track tuning.

### UNIDEN BEARCAT BC-950 XLT

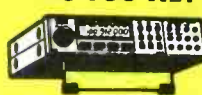

**\$249.99** (\$7.00 shipping)

Digital Programmable 100 Channel Scanner

BC-950 XLT covers the following frequencies: 29-54 MHz, 118-174 MHz, 406-512 MHz, 806-954 MHz (excludes cellular). Features compact size of 6-5/16" Wx11-5/8" Hx7-3/8", scan delay, priority, memory backup, channel lockout, bank scanning, key lock, AC/DC power cords, telescopic antenna, mounting bracket supplied, one year factory warranty, search, direct channel access, track tuning, service search including preprogrammed frequencies by pushing a single button for police fire/emergency, aircraft, weather, and marine services plus exclusive optional features never available on any scanner before. First is an RF receive amplifier for boosting weak signals for only \$34.99 plus a CTCSS tone board is available for only \$59.99 to make this the number one scanner available in the USA. Optional cigarette lighter plug #950 MPC \$4.99.

### MODEL: FB-911 ORIGINAL FIRE BOX PHONE

**\$54.99** (\$5.50 Shipping Each)



13 memory phone, 3 direct access emergency memories, auto radial, ringer on/off, top light flashes when telephone is ringing, tone/pulse switchable, desk/ wall mount, front door closes for authentic fire box appearance, FCC approved. Size: 16" Hx8 1/2" Wx7" D.

### GM-1™ GLASS MOUNT SCANNER ANTENNA

—ONLY AVAILABLE FROM SCANNER WORLD—

Frequency coverage 25-1200 MHz —only 22 inches tall. NEW REVISED DESIGN — no holes to drill — no glue needed. Complete with 17 foot cable, Motorola connector, and mounting hardware. Swivels to vertical position — performance unaffected by moisture on the window. Made in USA.

**SPECIAL \$39.99** (\$4.00 Shipping Each)

### GLASS MOUNT ANTENNAS FOR TRANSCEIVERS

Includes mounting kit and cable. Low Band, High band and UHF band include PL259 connectors. 800 cellular band antenna includes TNC connector.  
GM-27 27 MHz Low Band for CB \$39.99 (\$4.00)  
GM-155 144-174 MHz High Band \$39.99 (\$4.00)  
GM-450 450-470 MHz UHF Band \$39.99 (\$4.00)  
GM-800 Cellular Telephone Band \$34.99 (\$4.00)



**The New Realistic  
PRO-43 by  
Radio Shack**

Our 17th year of DISCOUNTS  
Freight Prepaid, Save Tax  
**Toll Free 800-231-3680**

PRO-43 List \$349.95

Our Delivered Price **\$274.95**

22511 Katy Fwy.

Katy (Houston), TX 77450

1-713-392-0747 FAX 713-574-4567

CIRCLE 110 ON READER SERVICE CARD

**YOU  
AIN'T HEARD  
NOTHIN'...YET**

Since 1967, CRB Research has been the world's leading publisher and supplier of unique hobby and professional books and information including:

- Scanner Frequency Guides
- Shortwave Frequency Guides
- Military/Federal Communications
- Broadcast Station Registries
- Undercover Communications
- Survival Communications
- Covert Operations
- Electronic Espionage
- Surveillance
- Monitoring
- Cryptography & Codes
- Bugging
- Wiretapping
- Communications Antennas
- Electronics & Projects
- Computer Technology
- & Other Related Topics!



**CRB RESEARCH  
P.O. Box 56,  
Commack, NY 11725**

CIRCLE 4 ON READER SERVICE CARD

**SURVEILLANCE TRANSMITTER KITS** tune from 65 to 305 MHz. Mains powered duplex, telephone, room, combination telephone/room. Catalog with **Popular Communications, Popular Electronics and Radio-Electronics** book reviews of "Electronic Eavesdropping Equipment Design." \$2.00. **SHEFFIELD ELECTRONICS**, P.O. Box 377785, Chicago, IL 60637-7785.

**Directory of U.S. Army Forts, Camps, & Airfields (1989-1945).** A 144 page illustrated book; more than 5,400 listings of named army installations from the Revolutionary War era right to end of WWII, includes Army Air Corps fields. Gives locations. Only \$15.95 plus \$3.50 shipping. NY State residents add \$1.56 sales tax. Order from CRB Research Books, P.O. Box 56, Commack, NY 11725.

**THE SCANNER HACKERS BIBLE** 112 modifications. Includes: PRO-2004/5/6, Yaesu, Kenwood, Bearcat, Icom and others. Frequency fixes, modifications (scan rates, interfaces, programmable channels, improving operation, etc.), antenna plans, operation, laws, cellular telephone operation and frequencies, accessories, 10-codes and more \$33.45. CODs: 1-602-782-2316 or FAX 1-602-343-2141 **TELECODE**, Box 6426-CQ, Yuma, AZ 85366-6426.

**PAN-COM INT'L CATALOG.** Over 350 Kits, Plans, Licensed/unlicensed AM/FM broadcasting, Ham/CB/SW/DX, 1750M transmitters. Surveillance devices. Computers/Software. Science Projects. **MORE** Box 130-P11, Paradise, CA 95967.

**WANTED:** Collins 51S general coverage receiver, any condition. Other Collins, Hallicrafters and Drake gear wanted. What have you? Trade? Have Nikon 8008 35-70 \$495. Neidich. 145E15-6A, NYC 10003. (212) 777-1332.

**UTC CONVERSION CHARTS.** Convenient WALLET SIZE CARDS convert any US or Canadian time zone to UTC and 24hour time instantly for WORLD BAND TUNING. ONLY \$1.00 ppd. 6 for \$5.00. NY residents add sales tax. **CAMM Enterprises**, Box 2625, Glenville, NY 12315-0625.

**Guide to the AR1000.** We publish a complete, 90-page guide for the operation and use of all AOR-AR1000 and Fairmate HP-100/200 scanners. Comes with 10 scan bank templates and a handy, 6-panel, folded Quick Reference Card. \$18.45 including S&H in the US. Design EQ, PO Box 1245-PC, Menlo Park, CA 94025. (415) 328-9181.

**INTO SCANNING/CB'ING?** Want quality accessories at good prices? Send a L.S.S.A.S.E. to: Able Cable, POB 197011, Louisville, KY 40259-7011.

**MILITARY MONITORING ANTENNAS:** broadband VHF/UHF discons, biconicals, satcom types, 30-1000mc., shipboard construction, "N" connectors, satcom preamps, antenna multicouplers, cables, accessories. (419) 726-2249.

**R-390-A SERVICE** module repair to complete remanufacture, cosmetic restoration. 20 years experience, expert service. 1-week turnaround, very reasonable, any condition accepted. (419) 726-2249.

**R-390-A SQUELCH MODIFICATION:** small external add-on module, super sensitive, works great on AM SSB, 15 minute installation, instructions included. \$25.00 (419) 726-2249.

**801-SCAN/801-HF Serious software to control your ICOM receiver!** 801-SCAN for VHF scanning with the R7000 or R9000 801-HF for HF listening with the R71A, R72, IC735 etc. IBM/clone w/640K required. Program from \$94.95, interface \$59.95. Demo program \$5. Specify receiver. M/C, VISA, check, or M.O. Terzon Systems, Inc., PO Box 835921, Richardson, TX 75083 (214) 234-8222.

**RCI-2950 OWNERS** New modification manual including Power increase, clarifier modification, modulation increase, operating hints, and more. Parts included. Only \$20.00 ppd in US (MO residents add \$1.15 sales tax). Scott, PO Box 510408, St. Louis, MO 63151-0408. (314) 846-0252. Money orders or COD.

I power my 35 watt VHF base from the sun. Report tells all. Send \$10.95. W. Gerosa, 405 Tarrytown Rd #212, White Plains, NY 10607.

**VOX** headset designed for use with handheld transceivers—ICOM, KENWOOD, YAESU, ALINCO—Universal type phono connectors make this compatible with most handhelds on the market today (2.5mm microphone, 3.5mm speaker) features include VOX, PTT manual, PTT locking with automatic safety time release, EXT PTT. Special introductory price—\$40.00. Call or write for details. RFL, PO Box 1124, Issaquah, WA 98027. (206) 727-3325.

**DYNAMIC** base station microphones with gooseneck type boom. 500 ohm impedance, pre-wired to fit most amateur and CB transceiver. \$40.00. Microphones carry 6 month limited warranty. VISA/MC and money orders accepted. No COD's. Call or write for details. RFL, PO Box 1124, Issaquah, WA 98027. (206) 727-3325.

**SCANNER FREQUENCY SEARCH SERVICE.** Hear all there is to hear! SASE to: Heald, 6886P Jefferson, North Branch, MI 48461.

**BIG AIR-SCAN 5TH EDITION** by Tom Kneitel. Complete guide to aero comms. Now in gigantic 192-page large-size format containing 60,000+ listings, including 2-30 MHz HF, 118 to 174 MHz VHF, 406 to 512 MHz UHF, and 800 MHz listings. Covers civil, military, private, and unlisted landing areas, heliports, and seaplane bases. Control towers, ground, approach/departure, FSS, unicoms, multicomms, crop dusters, air-ambulances, federal ops, traffic copiers, aviation business, airline enroute, airport security/fire, etc throughout USA. All Canadian mil, civilian airports and seaplane bases listed, plus lots more, including how-to text on aero monitoring. Most comprehensive aero frequency guide ever compiled. Only \$14.95 + \$3.50 postage to USA/Canada/APO/FPO. NY State residents add \$1.57 sales tax. From: CRB Research Books, Inc., P.O. Box 56, Commack, NY 11725, or ask your favorite communications dealer.

**NEW 1992 CB IMPORT/EXPORT RADIO CATALOG** - Hard to Find CB Dealers, Equipment, Modification Kits and Plans - \$3.00. **LORD/WYATT COMMUNICATIONS**, P.O. Box 030128PC, BROOKLYN, NY 11203-0001.

**LESCOMM** improved PRO-2006 - \$469.95. Includes: LED S Meter, squelch improvement, beep volume, SSB connector, 45-CPS, 760-1300MHz, warranty, Lescomm, PO Box 5212, Jacksonville, AR 72076.

**Advertiser's Index**

AMC Sales, Inc.	62
A.R.R.L.	60
Ace Communications	29,80,Cov. III
Advanced Electronic Applications	75
Antenna Specialists Co.	6
Antenna Supermarket	21
Antique Radio Classified	43
Auto-Sound Company	5
BMI, Inc.	73
Barry Electronics Corp.	62
CB City International, Inc.	43
C.E.T., Inc.	43
CRB Research	54,78
Cellular Security Group	32
Commtronics Engineering	51
Consumertronics	51
DECO	54
Datafile	51
Datametrix, Inc.	32
Davis Instruments	47
Delta Research	15
Drake, R.L. Company	7
EDE	43
Electron Processing	19
Electronic Equipment Bank	1
Fort Worth Computers	4
G & G Electronics	27
GRE America, Inc.	33
HR Bookstore	21
ICOM America, Inc.	Cov II, 39
J & J Enterprises	19
Japan Radio Company, Ltd.	8
Jo Gunn Enterprises	69
Kenwood USA Corporation	Cov. IV
L & L Electronics	54
Lentini Communications, Inc.	54
MFJ Enterprises, Inc.	14
Marymac Industries, Inc.	78
Microcraft Corporation	34
MoTron Electronics	62
National Amateur Radio Assoc.	4
Northwest Communications Labs	54
OFS WeatherFAX	15
Official Scanner Guide	18
OPTOelectronics	13,17
POP COMM Communications Guide	79
RF Limited	49
Radio Shack	23
REACT International	37
SGC, Inc.	49
Satman, Inc.	51
Scanner World USA	77
Scrambling News	62
Signal Engineering	57
Software Systems Consulting	27,71
Systems & Software Int'l Ltd.	43
Turbo Electronics	37
Universal Radio, Inc.	3
Vanguard Electronic Labs	57
Viking International	47
Wilson Antenna, Inc.	53
WorldCom Technology	62
Xandi Electronics	37

**Reach this dynamic audience with your advertising message, contact Don Allen, N9ALK at (217) 344-8653, FAX 217-344-8656.**

# 1993 POPULAR COMMUNICATIONS COMMUNICATIONS GUIDE

Completely updated with the latest information on new receivers, scanners and amateur transceivers, the Winter Communications Guide has something for everyone!

## ARTICLES AND INSIGHT YOU WON'T FIND ANYWHERE ELSE!

You can get the specs and prices on all the products to make your shack complete, from top-of-the-line receivers to SWR meters, our Guide has it all. You'll learn how and where to hear the "tough ones," how to select and install a mobile CB antenna and how to tune in the aircraft bands from the writers who REALLY KNOW the ins and outs of SWling and DXing. As an added bonus, an in-depth article by Chuck Gysi gives you the inside scoop on hearing all the sports action, whether you're at the races or ballpark.

\*\* If you're a new Technician class ham, there's a bonus article to help you learn the ropes of using a repeater.

\*\* For scanner enthusiasts, noted skip communications expert, Chuck Robertson tells you all about skip scanning; how to hear those distant stations on your scanner!

\*\* Want to know how the experts tune those distant stations? Harry Helms offers tips and techniques in a super article, titled, "Secrets and Tricks of DXing."

\*\* Gerry Dexter has updated the SW Tuning Guide, giving you the very latest times and frequencies of English language broadcasts. Plus many more features by noted writers and world-class DXers, Fred Maia, Bill Sanders, Don Schimmel, Bill Price, John Hoot, Harold Ort and more!

\*\*\* **EXTRA! EXTRA!** A new addition to the Winter Communications Guide, called, "What's News and Where to Hear It," gives you a quick reference of the world's hot spots and how to hear them. Hear the news from the source with this NEW addition to our Communications Guide! \*\*\*

Standard features like the extensive Product Listings and Manufacturer/Dealer Listings round out the Guide, making it the most authoritative book of its kind in the communications world!

Reserve your copy today! Issues will be mailed directly from the printer no later than November 17, 1992.

Mail to: CQ Communications, Inc.  
76 North Broadway, Hicksville, NY 11801  
Phone: 516-681-2922/FAX: 516-681-2926

YES, please send me \_\_\_\_\_ copies at \$4.95 each:

Name \_\_\_\_\_ Call \_\_\_\_\_

Address \_\_\_\_\_

City \_\_\_\_\_ State \_\_\_\_\_ Zip \_\_\_\_\_

Send only \$4.95 each (plus \$2.50 shipping & handling; \$3.50 foreign)-

Check  Money Order  MasterCard  VISA  AMEX

My account number is: \_\_\_\_\_ Expiration date: \_\_\_\_\_

--	--	--	--

# POPULAR COMMUNICATIONS



## Subscribe today and Save!

The World's largest, most authoritative monthly magazine for Short Wave Listening and Scanner Monitoring. Read by more active listeners than all other listening publications *combined!* If you enjoy radio communications you'll love **Pop'Comm!**

Mail to: CQ Communications, Inc.  
76 North Broadway, Hicksville, NY 11801  
Phone: 516-681-2922/FAX: 516-631-2926

YES, please send me Popular Communications

- 1 year - 12 issues \$19.95  
 2 years - 24 issues \$38.00  
 3 years - 36 issues \$57.00

Canada/Mexico—One year \$22.00, two years \$42.00, three years \$63.00; Foreign—one year \$24.00, two years \$46.00, three years \$69.00. Foreign Air Mail—one year \$77.00, two years \$152.00, three years \$228.00.

Note: Allow 6-8 weeks for delivery of first issue.

Name \_\_\_\_\_

Street \_\_\_\_\_

City \_\_\_\_\_

State \_\_\_\_\_ Zip \_\_\_\_\_

Check  Money Order  MasterCard  VISA  AMEX

My account number is: \_\_\_\_\_ Expiration date: \_\_\_\_\_

--	--	--	--



# AOR Scanners.

Great Performance. Great Service. Great Value.



**NEW!  
EXTENDED  
COVERAGE!**

**AR1000**

**\$429**

**1000 Channels. 500KHz to 1300MHz**

**Standard Features:**

- Extremely compact size.
- Continuous coverage.
- Antenna attenuator switch, 10db.
- Manual tuning knob.
- Earphone jack, 3.5mm.
- AM, FM and wide band FM tuning modes.
- Backlighted LCD display.
- 10 Scan Banks, 10 Search Banks.
- Selectable Priority Channel.
- Delay, Hold Features.
- Selectable Search Increments, 5-955KHz.
- Permanent memory backup.
- 4 AA Ni Cad batteries included.
- AC adaptor/charger.
- Carry Case.
- Cigarette Lighter Charger.
- Belt Clip.
- Earphone.

**Options:**

External Speaker. Mobile Mount. MS190 \$19.50  
 Extended Warranty. 2/3 yrs \$45/\$55

**Specifications:**

Coverage: 500KHz-1300MHz  
 Sensitivity: .35uV NFM, 1.0uV WFM, 1.0AM  
 Speed: 20 ch/sec. scan. 40 ch/sec. search  
 IF: 561.225, 58.075, 455KHz or 10.7MHz  
 Increments: 5 to 955KHz selectable/ 5 or 12.5 steps.  
 Audio: .4 Watts  
 Power: Input 9 - 13.8 V. DC  
 Antenna: BNC  
 Display: LCD  
 Dimensions: 6 7/8H x 1 3/4D x 2 1/2W. 12oz wt.

**AR950/AR900**

**\$289/\$199**



**100 Channels. Low, Air, High, UHF & 800MHz.**

**Standard Features:**

- Extremely compact size.
- Unrestricted 800MHz coverage.
- 100 channels permanent memory.
- Earphone Jack.
- Delay, Hold features.
- Channel 1 Priority.
- 5 Scan Banks, 5 Search Banks.
- Two antennas included.
- AC & DC Power cord w/mobile mnt. hrdwr. (AR950)
- NiCad battery w/chgr adapter. (AR900)
- One Year Limited Warranty.

**Options:**

Base type antenna		
25 to 1000MHz w 50'coax.	AS300	\$59.95
Mag Mnt Mobile Antenna. 15' coax.	MA100	\$25.00
Cigarette Lighter power adaptor.	CP100	\$5.00
Wide band preamp	GW-2	\$89.00
Extended Warranty. 2/3 yrs		\$40/\$55

**Specifications:**

Coverage: 27-54, 108-174, 406-512, 830-950MHz  
 Sensitivity: .4uV Lo,Hi. .8uV Air. .5uV UHF. 1.0uV 800  
 Scan Speed: 15 ch/sec.  
 IF: 21.4MHz, 455KHz  
 Increments: 10,12.5,25,30  
 Audio: 1W  
 Power: 12.8VDC, 200MA  
 Antenna: BNC  
 Display: LCD w/backlight  
 Dimensions: 2 1/4H x 5 5/8W x 6 1/2D. 14oz wt. (AR950)  
 5 3/4H x 2W x 1 1/2D. 12oz wt. (AR900)

**We offer 100's of communications products.**

# Unbelievable Price.

**AR2500**

**\$429**



## 2016 Channels. 1 MHz to 1500 MHz

### Standard Features:

- continuous coverage.
- AM, FM, wide band FM, & BFO for SSB, CW.
- 64 Scan Banks.
- 16 Search Banks.
- RS232 port built in.
- Includes AC/DC pwr crd. Antenna, Mntng Brckt.
- One Year Limited Warranty.

### Options:

Earphone.	EP200	\$2.00
External Speaker. Mobile Mount.	MS190	\$19.50
Extended Warranty. 2/3 yrs.		\$65/\$75
Mobile Mounting Bracket.	MM1	\$14.90
RS232 Control Package	SCS2	\$295.00
(software & cable) offers spectrum display and database.		
Wide band preamp	G-W2	\$89.00

### Specifications:

Coverage:	1MHz-1500MHz
Sensitivity:	.35uV NFM, 1.0uV WFM, 1.0AM/SSB/CW
Speed:	38 ch/sec. scan. 38 ch/sec. search
IF:	750.00, 45.0275, 5.5MHz 455KHz
Increments:	5,12,5,25 KHz
Audio:	1.2 Watts at 4 ohms
Power:	Input 13.8 V. DC 300mA
Antenna:	BNC
Display:	LCD, backlighted
Dimensions:	2 1/4H x 5 5/8W x 6 1/2D Wt. 1lb.

**AR3000**

**\$1095**



## 400 Channels. 100KHz to 2036MHz.

### Standard Features:

- Extremely compact size.
- Continuous coverage.
- Attenuation Programmable by Channel.
- Manual tuning knob.
- Tuning increments down to 50Hz.
- AM, FM, wide band FM, LSB, USB, CW modes.
- Backlighted LCD display.
- 4 Scan and Search Banks, Lockout in Search.
- 4 Priority Channels.
- RS232 control through DB25 connector.
- Delay, Hold Features.
- 15 band pass filters, GaAsFET RF amp.
- Sleep and Alarm Features.
- AC adaptor / charger. DC power cord.
- Telescopic Antenna
- One Year Limited Warranty.

### Options:

Earphone.	EP200	\$2.00
External Speaker. Mobile Mount.	MS190	\$19.50
Extended Warranty. 2/3 yrs.		\$65/\$75
Mobile Mounting Bracket.	MM1	\$14.90
RS232 Control Package	SCS3	\$295.00
(software & cable) offers spectrum display and database.		
Wide band preamp	G-W2	\$89.00

### Specifications:

Coverage:	100KHz-2036MHz
Sensitivity:	.35uV NFM, 1.0uV WFM, 1.0AM/SSB/CW
Speed:	20 ch/sec. scan. 20ch/sec. search
IF:	736.23, (352.23) (198.63) 45.0275, 455KHz
Increments:	50Hz and greater
Audio:	1.2 Watts at 4 ohms
Power:	Input 13.8 V. DC 500mA
Antenna:	BNC
Display:	LCD
Dimensions:	3 1/7H x 5 2/5W x 7 7/8D Wt. 2lb 10oz.

# To Order Call 1•800•445•7717

In All 50 States and Canada. 24 Hours a Day. Fax Orders: 1-800-448-1084, 24 Hours a Day.

ACE Communications Monitor Division 10707 E. 106th Street, Fishers, IN 46038

Int'l Voice# 317-842-7115. Int'l Fax# 317-849-8794.

Service and Support Lines: Mon-Fri 9a.m. to 9p.m., Saturday 10-4. EST

MasterCard, Visa, American Express, Checks, Approved P.O.'s. & C.O.D. (add 5.00)

Prices and specifications subject to change.

# KENWOOD

## Hear it All!



### R-5000

**R-2000**  
High performance receivers

Scan the world bands with Kenwood's R-5000, R-2000 and RZ-1. Listen in on foreign music, news, and commentary. Monitor local police, fire, and other public safety services, as well as the Marine channels, and the many other services.

*(The VHF converter options must be used in the R-5000 and R-2000.)*

### R-5000

The R-5000 is a high performance, top-of-the-line receiver, with 100 memory channels, and direct keyboard or main dial tuning—makes station selection



### R-2000

The R-2000 is an all band, all mode receiver with 10 memory channels and many deluxe features such as programmable scanning, dual 24-hour clocks with timer, all-mode squelch and noise blankers, a large, front-mounted speaker, 110 volt AC or 12 volt DC operation (with the DCK-1 cable kit), and 118-174 MHz VHF capability with VC-10 option.

#### Optional Accessories

**R-2000:**  
 •VC-10 VHF converter  
 •DCK-1 DC cable kit for 12 volt DC use.

#### R-5000:

•VC-20 VHF converter •VS-1 Voice module •DCK-2 for 12 volt DC operation  
 •YK-88A-1 AM filter •YK-88SN SSB filter •YK-88C CW filter •MB-430 Mounting bracket.

#### Other Accessories:

•SP-430 External speaker •SP-41 Compact mobile speaker •SP-50B Mobile speaker •HS-5 Deluxe headphones •HS-6 Lightweight headphones

super easy! Other useful features include programmable scanning, large, built-in speaker, 110 volt AC or 12 volt DC operation (with optional DCK-2 cable), VHF capability (108-174 MHz) with the VC-20 option, dual 24-hour clocks with timer, and even voice frequency readout with the VS-1 option.

### RZ-1

**Wide-band scanning receiver**



The RZ-1 wide-band, scanning receiver covers 500 kHz-905 MHz, in AM, and narrow or wideband FM. The automatic mode selection function makes listening

easier. One hundred memory channels with message and band marker, direct keyboard or VFO frequency entry, and versatile scanning functions, such as memory channel and band scan, with four types of scan stop. The RZ-1 is a 12 volt DC operated, compact unit, with built-in speaker, front-mounted phones jack, squelch for narrow FM, illuminated keys, and a "beeper" to confirm keyboard operation.

**Optional Accessory**  
 •PG-2N Extra DC cable

KENWOOD U.S.A. CORPORATION  
 COMMUNICATIONS & TEST EQUIPMENT GROUP  
 P.O. BOX 22745, 2201 E. Dominguez Street  
 Long Beach, CA 90801-5745  
 KENWOOD ELECTRONICS CANADA INC.  
 P.O. BOX 1075, 959 Gana Court  
 Mississauga, Ontario, Canada L4T 4C2

# KENWOOD

...pacesetter in Amateur Radio

CIRCLE NO. 1 ON FREE INFORMATION CARD

Specifications, features, and prices are subject to change without notice or obligation.